



Polamco | Polamco Braid Tail Backshell

TE Internal #: BAE0201-00

Polamco Braid Tail Backshell, Ruggedized Backshells & Adapters, Aluminum, Electroless Nickel, Cable Diameter Range 0 – 28.6 mm, 90, Braided

[View on TE.com >](#)

Connectors > Connector Backshells & Adapters > Ruggedized Backshells & Adapters



Backshell Material: **Aluminum**

Adapter Plating Material: **Electroless Nickel**

Cable Diameter Range: **0 – 28.6 mm**

Adapter Angle: **90**

Termination Device Type: **Braided**

Features

Product Type Features

Adapter Angle	90
Termination Device Type	Braided
Connector Shell Size	25

Body Features

Color	Bright
Backshell Material	Aluminum
Adapter Plating Material	Electroless Nickel
Adapter Entry Size	18

Dimensions

Cable Diameter Range	0 – 28.6 mm
----------------------	-------------

Usage Conditions

Salt Spray Resistance	48 Hr
Operating Temperature Range	-65 – 200 °C[-85 – 392 °F]

Product Compliance

[For compliance documentation, visit the product page on TE.com>](#)

EU RoHS Directive 2011/65/EU	Not Yet Reviewed
EU ELV Directive 2000/53/EC	Not Yet Reviewed
China RoHS 2 Directive MIIT Order No 32, 2016	Not reviewed for China RoHS compliance
EU REACH Regulation (EC) No. 1907/2006	Current ECHA Candidate List: JUL 2021 (219) Not Yet Reviewed
Halogen Content	Not Yet Reviewed for halogen content
Solder Process Capability	Not reviewed for solder process capability

Product Compliance Disclaimer

This information is provided based on reasonable inquiry of our suppliers and represents our current actual knowledge based on the information they provided. This information is subject to change. The part numbers that TE has identified as EU RoHS compliant have a maximum concentration of 0.1% by weight in homogenous materials for lead, hexavalent chromium, mercury, PBB, PBDE, DBP, BBP, DEHP, DIBP, and 0.01% for cadmium, or qualify for an exemption to these limits as defined in the Annexes of Directive 2011/65/EU (RoHS2). Finished electrical and electronic equipment products will be CE marked as required by Directive 2011/65/EU. Components may not be CE marked. Additionally, the part numbers that TE has identified as EU ELV compliant have a maximum concentration of 0.1% by weight in homogenous materials for lead, hexavalent chromium, and mercury, and 0.01% for cadmium, or qualify for an exemption to these limits as defined in the Annexes of Directive 2000/53/EC (ELV). Regarding the REACH Regulations, TE's information on SVHC in articles for this part number is still based on the European Chemical Agency (ECHA) 'Guidance on requirements for substances in articles' (Version: 2, April 2011), applying the 0.1% weight on weight concentration threshold at the finished product level. TE is aware of the European Court of Justice ruling of September 10th, 2015 also known as O5A (Once An Article Always An Article) stating that, in case of 'complex object', the threshold for a SVHC must be applied to both the product as a whole and simultaneously to each of the articles forming part of its composition. TE has evaluated this ruling based on the new ECHA "Guidance on requirements for substances in articles" (June 2017, version 4.0) and will be updating its statements accordingly.

Compatible Parts



Also in the Series | [Polamco Braid Tail Backshell](#)



Ruggedized Backshells & Adapters(78)

Customers Also Bought

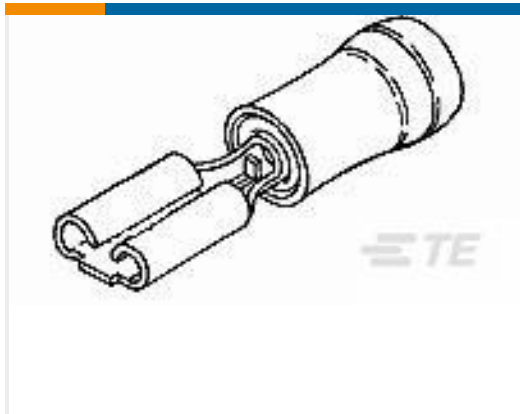

TE Part #165616-5
110 PIDG FASTON REC



TE Part #7-1676123-7
1/2W SM M/OX 5% 1K2



TE Part #7-1676123-9
1/2W SM M/OX 5% 1K5



TE Part #6-1676123-0
1/2W SM M/OX 5% 240R

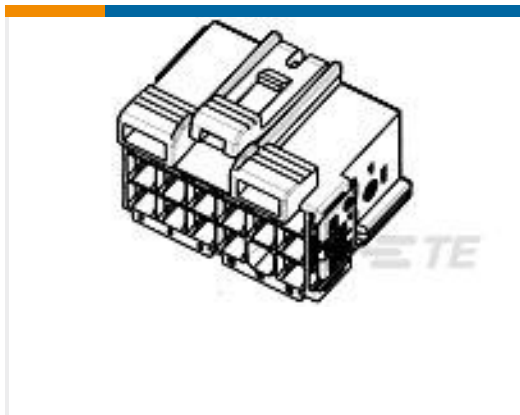

TE Part #1241581-2
JUN-POW-TIM GEH 17P



TE Part #926647-2
15P UN-MNL AUFN-GEH



TE Part #YAFD54-12-10SNC127
RECP ASSY



TE Part #YAFD57-12-10PNC127
PLUG ASSY

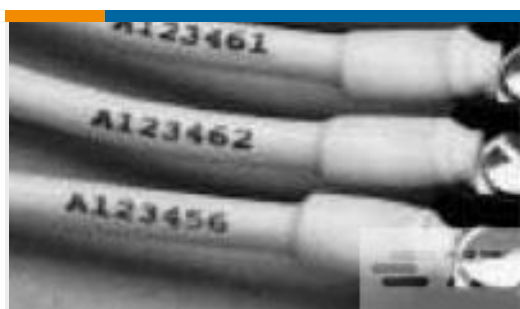

TE Part #5054324002
RNF-100-1-1/2-3-SP

Documents

Product Drawings

[70H3-25-18-1-C-SE](#)

English

Datasheets & Catalog Pages

[MATERIAL AND FINISH DETAILS](#)

English