

Molded SMD Power Inductor



AMSLA-1280

Request Samples



Check Inventory



12.0 x 8.0 x 7.0 mm
RoHS/RoHS II Compliant
MSL Level = 2

Features

- Shielded construction
- Soft saturation
- High Power Density
- Low DCR, High Efficiency
- Designed for switching frequencies between 100KHz-2MHz

Applications

- Desktop/ Server applications
- High current point-of-load (POL) converters
- Lighting
- Solar inverters and power
- Industrial and robotics
- Medium and high-power switch mode power supplies.

Electrical Specifications

Part Number	Inductance	Tolerance	DC Resistance	Saturation Current	Temperature Rise Current
	0.1MHz/1V		Max	Max	Max
Units	μ H	%	m Ω	A	A
Symbol	L	K, M	DCR	Isat	Irms
AMSLA-1280-R22	0.22	10, 20	0.31	54	50
AMSLA-1280-R23	0.23	10, 20	0.31	50	50

Test Conditions

Isat: DC current at which the inductance drops 20% from its value without current.

Irms: DC current that causes the temperature rise (ΔT , approximate 40 °C) from 20°C ambient

Operating Temperature: -40°C ~ +125°C (including self-temperature rise)

Storage Condition: -40°C ~ +125°C (on board), -10°C ~ +40°C (with packaging), and R.H. 60 max

Operating Voltage: 40V (across inductor)

AMSLA-1280 Series is RoHS Compliant and Pb free

AMSLA-1280 is commercial grade.

Molded SMD Power Inductor



AMSLA-1280

Request Samples



Check Inventory



12.0 x 8.0 x 7.0 mm
RoHS/RoHS II Compliant
MSL Level = 2

Part Number Identification

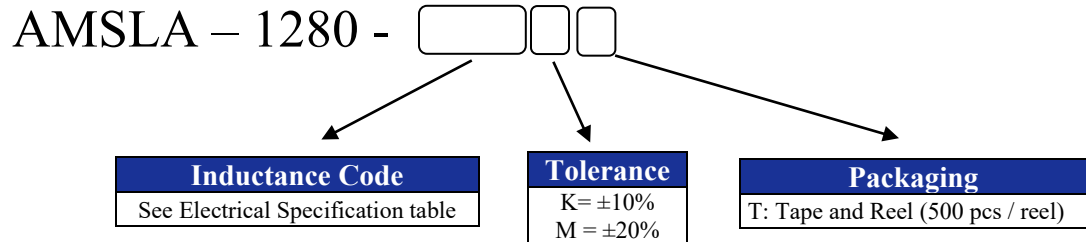

Marking

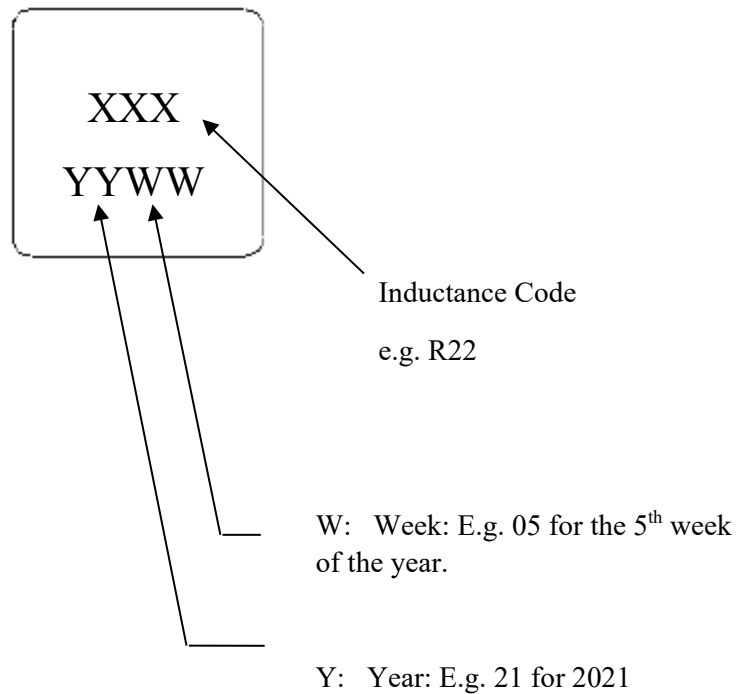

Marking Method = Ink Marking



5101 Hidden Creek Ln Spicewood TX 78669
Phone: 512-371-6159 | Fax: 512-351-8858
For terms and conditions of sales, please visit:
www.abracon.com

REVISED: 10-22-21

ABRACON IS
ISO9001-2015
CERTIFIED

Molded SMD Power Inductor



AMSLA-1280

Request Samples



Check Inventory



12.0 x 8.0 x 7.0 mm
RoHS/RoHS II Compliant
 MSL Level = 2

Mechanical Dimensions

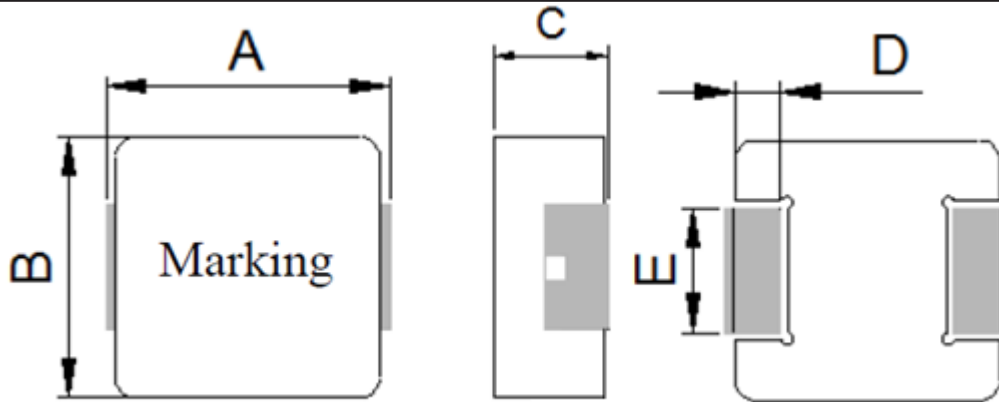

Series	A	B	C	D	E
AMSLA-1280	12.0 MAX	8.0 MAX	7.0 MAX	2.54 ± 0.3	3.0 ± 0.2

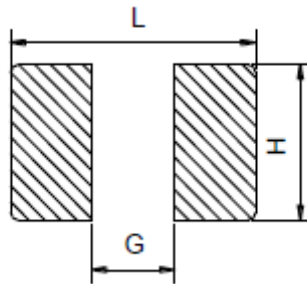

L	G	H
12.8 Ref.	6.0 Ref.	3.5 Ref.

Dimensions: mm

Molded SMD Power Inductor



AMSLA-1280

Request Samples



Check Inventory



12.0 x 8.0 x 7.0 mm
RoHS/RoHS II Compliant
MSL Level = 2

Materials

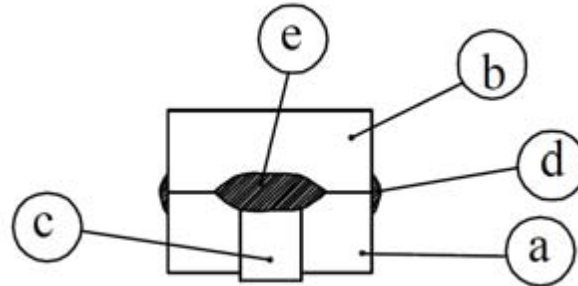

	Components	Material
a	Core	Manganese-Zinc Ferrite
b	Core	Manganese-Zinc Ferrite
c	Electrode	Nickel-Tin
d	Adhesive (Top)	KAA11700xx (Black)
e	Adhesive (Bottom)	6030H (Black)

Molded SMD Power Inductor



AMSLA-1280

Request Samples



Check Inventory



12.0 x 8.0 x 7.0 mm
RoHS/RoHS II Compliant
 MSL Level = 2

Reflow Profile

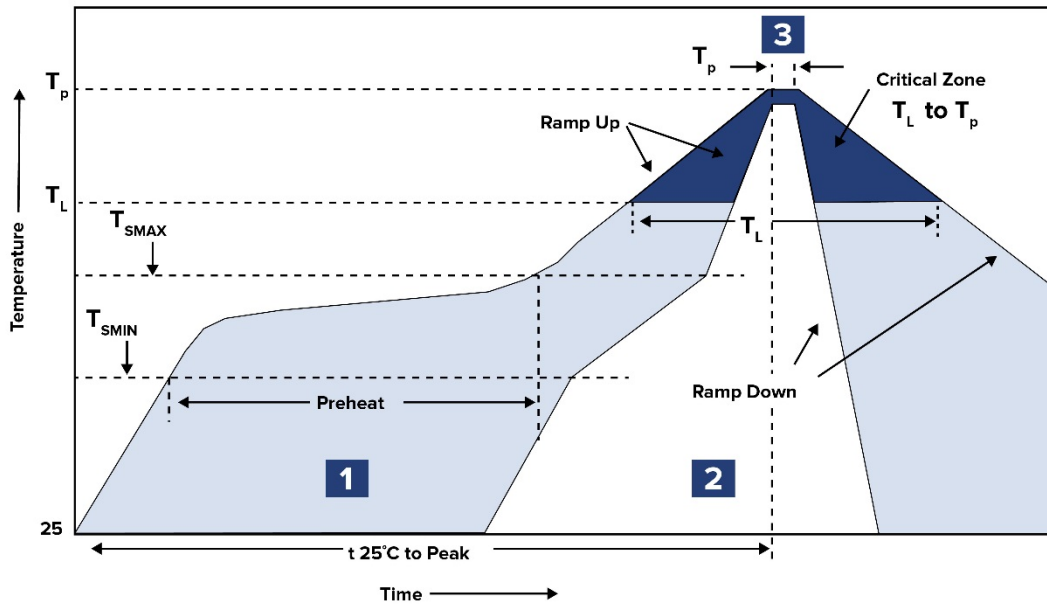

Zone	Description	Temperature	Times
1	Preheat	$T_{SMIN} \sim T_{SMAX}$ 150°C ~ 200°C	60 ~ 120 sec.
2	Reflow	T_L 217°C	60 ~ 150 sec.
3	Peak heat	T_P 260°C	10 sec. MAX

Molded SMD Power Inductor



AMSLA-1280

Request Samples



Check Inventory



12.0 x 8.0 x 7.0 mm
RoHS/RoHS II Compliant
MSL Level = 2

Packaging

Tape & Reel: 500 pcs/reel

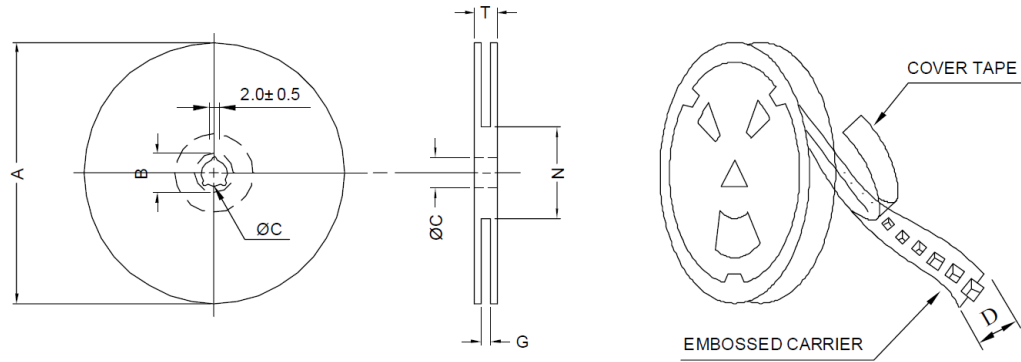
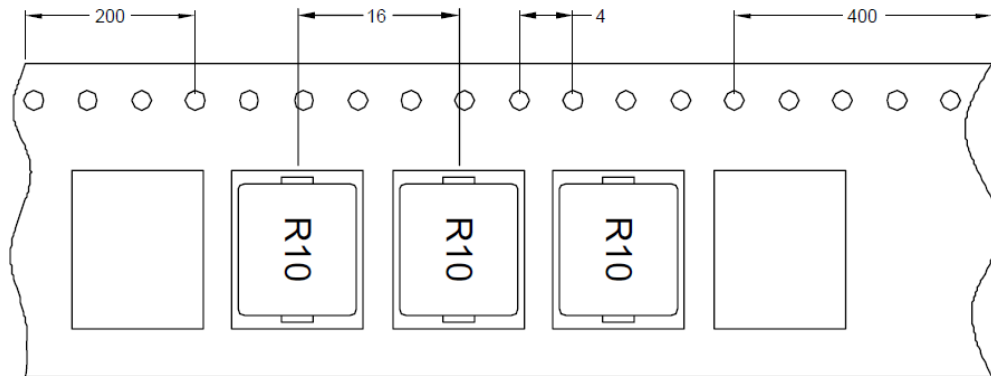

A	B	C	D	G	N	T
330	21 ±0.8	13.0±0.5	24.0	26.0 Max	50.0 Min	30.4

ATTENTION: Abracon LLC's products are COTS – Commercial-Off-The-Shelf products; suitable for Commercial, Industrial and, where designated, Automotive Applications. Abracon's products are not specifically designed for Military, Aviation, Aerospace, Life-dependent Medical applications or any application requiring high reliability where component failure could result in loss of life and/or property. For applications requiring high reliability and/or presenting an extreme operating environment, written consent and authorization from Abracon LLC is required. Please contact Abracon LLC for more information.



5101 Hidden Creek Ln Spicewood TX 78669
 Phone: 512-371-6159 | Fax: 512-351-8858
 For terms and conditions of sales, please visit:
www.abracon.com

REVISED: 10-22-21

ABRACON IS
 ISO9001-2015
 CERTIFIED