

REVISIONS					
REV	ECO	DESCRIPTION	DATE	BY	APPR
A1	--	PERLIMINARY DESIGN	03/NOV/14	ORION	TOMMY
A2	--	REVISE DIMENSION	21/JUL/20	LOUIE	TOMMY

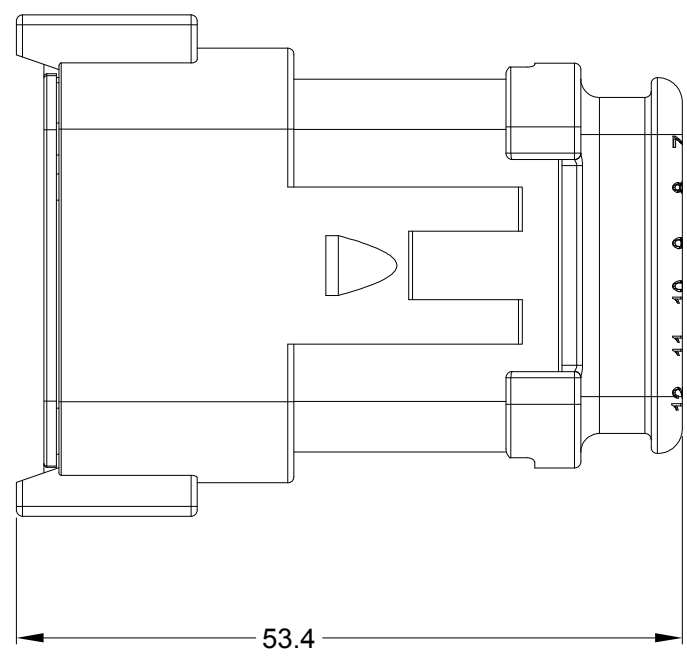
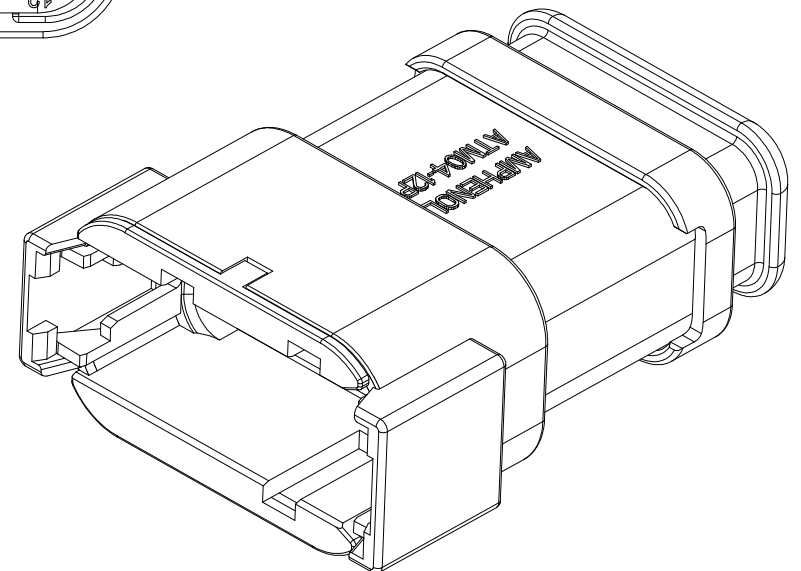
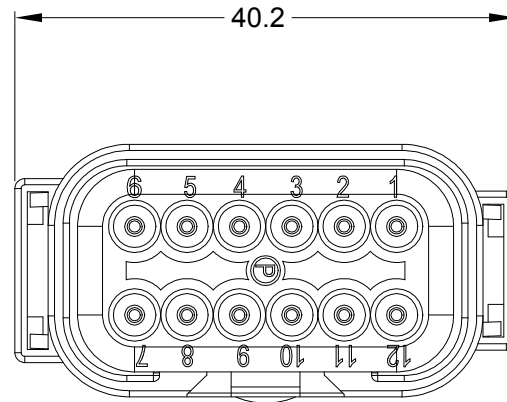
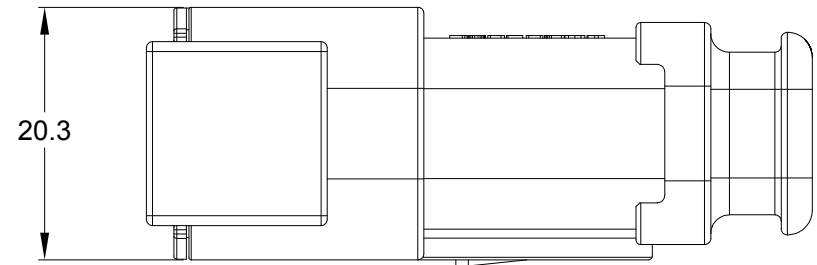
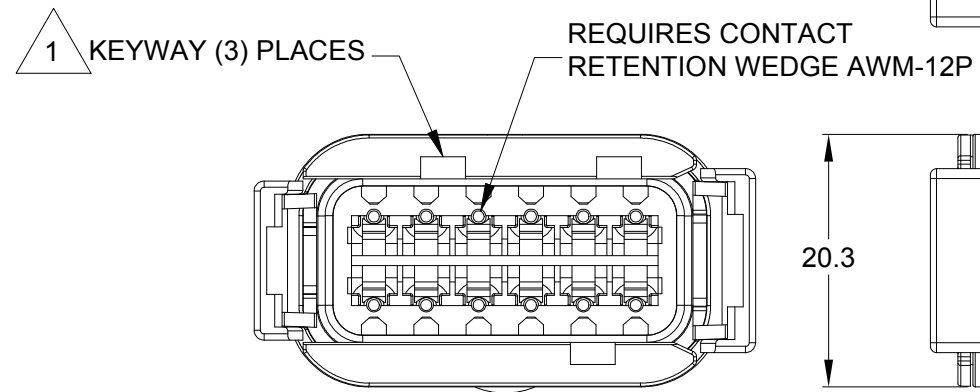
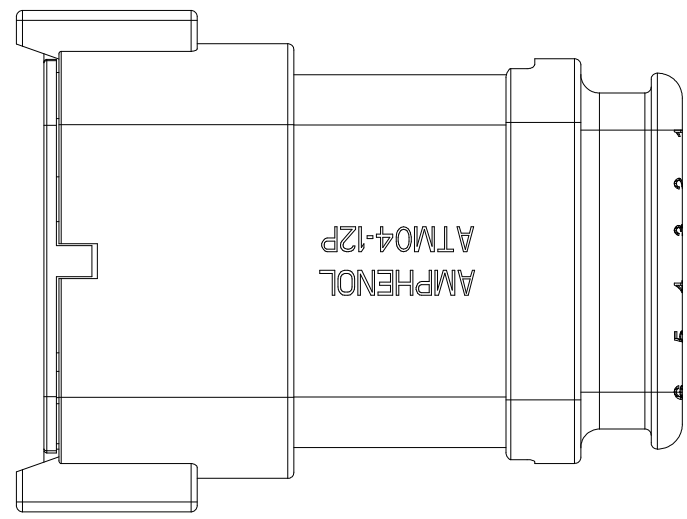

NOTES: UNLESS OTHERWISE SPECIFIED

1. SEE SHEET 2 FOR KEY ARRANGEMENTS AND COLORS.
2. MATERIAL:
HOUSING: THERMOPLASTIC
SEAL: SILICONE RUBBER
3. MODIFICATIONS: STRAIN RELIEF END CAP
4. SPECIFICATIONS:
 - 4.1 CURRENT RATING: 7.5 AMPS
 - 4.2 OPERATING TEMPERATURE: -55°C TO +125°C.
 - 4.3 DIELECTRIC WITHSTANDING VOLTAGE: LESS THAN 2 MILLIAMPS CURRENT LEAKAGE @ 1500 VOLTS AC.
 - 4.4 INSULATION RESISTANCE: 1000 MEGOHMS MIN @ 25°C.
 - 4.5 MOISTURE RESISTANCE: IP67 (MATED CONDITION)
 - 4.6 MATING CYCLE DURABILITY: 100 CYCLES
 - 4.7 RoHS COMPLIANT
5. MATING PART: ATM06-12SX* PLUG.
(X = A,B,C,D KEYS; * = MODIFICATIONS AND COLORS)
6. ALL DIMENSIONS ARE FOR REFERENCE USE ONLY.
7. CONTACT SIZE AND REAR SEAL WIRE RANGE:

CONTACT SIZE	MIN. INSUL O.D.	MAX. INSUL O.D.	TYPICAL WIRE RANGE
20	1.35 mm (.053 in)	3.05 mm (.120 in)	16 - 22 AWG

TITLE: RECEPTACLE, KEYED, 12 PIN, STRAIN RELIEF, ATM SERIES
DWG NO: ATM04-12PX-SR1XX
REV: A2
SH: 1
OF: 2

QUANTITY	SEE SHEET 2	PART NUMBER	DESCRIPTION	ITEM
MATERIALS LIST				
UNLESS OTHERWISE SPECIFIED		SIGNATURES		DATE
1) All dimensions are in metric(mm).		DRAWN: LOUIE		21/JUL/20
2) Tolerances are as follows:		CHECKED: ORION		22/JUL/20
1 PL DEC ±0.30		ENGINEER:		
2 PL DEC ±0.15		APPROVAL: TOMMY		23/JUL/20
3 PL DEC ±0.08		CUSTOMER:		
3) Note reference =		THIS DRAWING IS SUPPLIED FOR INFORMATION ONLY. DESIGN FEATURES, SPECIFICATIONS AND PERFORMANCE DATA SHOWN HEREON ARE THE PROPERTY OF THE AMPHENOL CORPORATION. NO RIGHTS OF REPRODUCTION ARE IMPLIED. ALL DIMENSIONS ARE SUBJECT TO NORMAL MANUFACTURING VARIATIONS.		
MATERIAL SPECIFICATIONS:		<p style="text-align: center;">Amphenol</p> <p style="text-align: center;">Sine Systems - www.amphenol-sine.com 44724 Morley Drive Clinton Township, MI 48036</p> <p style="text-align: center;">RECEPTACLE, KEYED, 12 PIN, STRAIN RELIEF ATM SERIES</p>		
PROCESS SPECIFICATIONS:				
NEXT ASS'Y:		SIZE	TYPE	DWG NO:
		B	C-	ATM04-12PX-SR1XX
		SCALE:	REVISION	
		NONE	A2	
		SHEET 1 OF 2		

REVISIONS					
REV	ECO	DESCRIPTION	DATE	BY	APPR

P/N ATM04-12PA-SR1GY
KEY-A CONFIGURATION
STANDARD COLOR: GREY

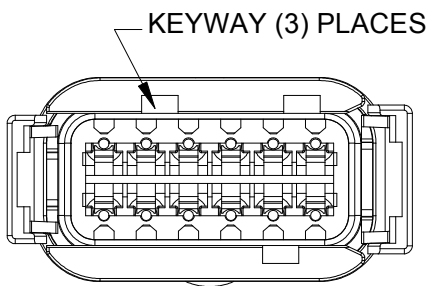
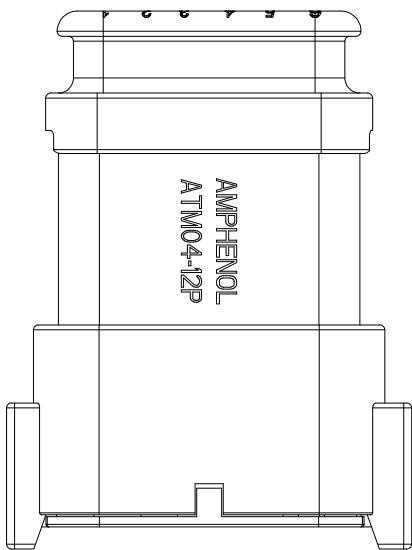

KEY-A CONFIGURATION	
COLOR	PART NUMBER
* GREY	ATM04-12PA-SR1GY
BLACK	ATM04-12PA-SR1BK
GREEN	ATM04-12PA-SR1GN
BROWN	ATM04-12PA-SR1BN

P/N ATM04-12PB-SR1BK
KEY-B CONFIGURATION
STANDARD COLOR: BLACK

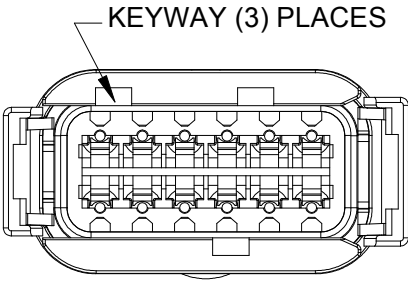
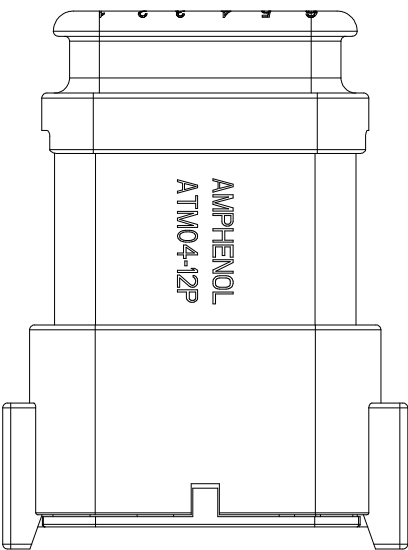

KEY-B CONFIGURATION	
COLOR	PART NUMBER
GREY	ATM04-12PB-SR1GY
* BLACK	ATM04-12PB-SR1BK
GREEN	ATM04-12PB-SR1GN
BROWN	ATM04-12PB-SR1BN

P/N ATM04-12PC-SR1GN
KEY-C CONFIGURATION
STANDARD COLOR: GREEN

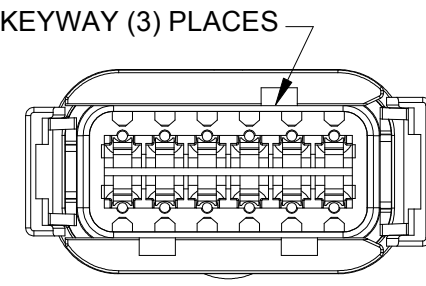
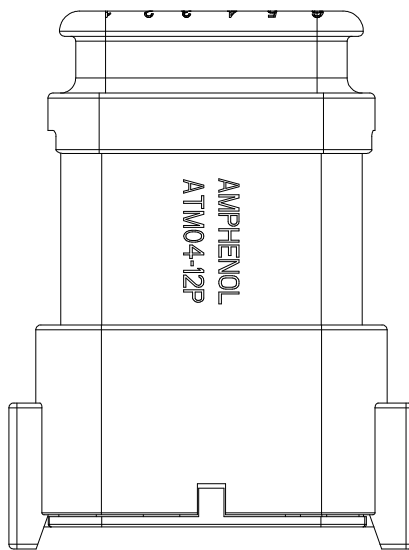

KEY-C CONFIGURATION	
COLOR	PART NUMBER
GREY	ATM04-12PC-SR1GY
BLACK	ATM04-12PC-SR1BK
* GREEN	ATM04-12PC-SR1GN
BROWN	ATM04-12PC-SR1BN

P/N ATM04-12PD-SR1BN
KEY-D CONFIGURATION
STANDARD COLOR: BROWN

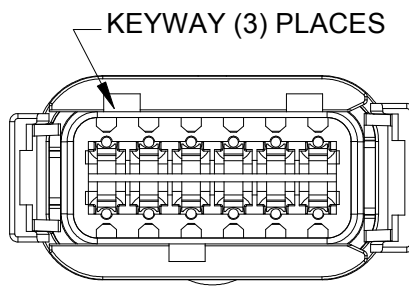
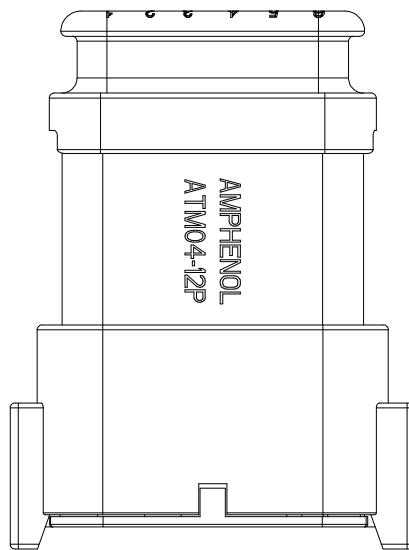

KEY-D CONFIGURATION	
COLOR	PART NUMBER
GREY	ATM04-12PD-SR1GY
BLACK	ATM04-12PD-SR1BK
GREEN	ATM04-12PD-SR1GN
* BROWN	ATM04-12PD-SR1BN

NOTE:

AN ASTERISKS (*) PLACED BEFORE THE COLOR DENOTES THE STANDARD MOLDED COLOR OF THE CONNECTORS SHOWN ABOVE.



OTHER COLORS SHOWN ARE AVAILABLE VIA SPECIAL ORDER.



QUANTITY	PART NUMBER	DESCRIPTION	ITEM
MATERIALS LIST			
UNLESS OTHERWISE SPECIFIED 1) All dimensions are in metric(mm). 2) Tolerances are as follows: 1 PL DEC ±0.30 2 PL DEC ±0.15 3 PL DEC ±0.08 3) Note reference = \triangle X		SIGNATURES DRAWN: LOUIE CHECKED: ORION ENGINEER: APPROVAL: TOMMY DATE 21/LOUIE/20 22/LOUIE/20 23/JUL/20	<h1>Amphenol</h1> Sine Systems - www.amphenol-sine.com 44724 Morley Drive Clinton Township, MI 48036
MATERIAL SPECIFICATIONS: PROCESS SPECIFICATIONS: NEXT ASSY:		CUSTOMER: THIS DRAWING IS SUPPLIED FOR INFORMATION ONLY. DESIGN FEATURES, SPECIFICATIONS AND PERFORMANCE DATA SHOWN HEREON ARE THE PROPERTY OF THE AMPHENOL CORPORATION. NO RIGHTS OF REPRODUCTION ARE IMPLIED. ALL DIMENSIONS ARE SUBJECT TO NORMAL MANUFACTURING VARIATIONS.	
SIZE B C-		DWG NO. ATM04-12PX-SR1XX	REVISION A2
SCALE NONE		SHEET 2 OF 2	

TITLE: RECEPTACLE, KEYED, 12 PIN STRAIN RELIEF, ATM SERIES
DWG NO.: ATM04-12PX-SR1XX
REV: A2
SH: 2
OF: 2



ATM Series™ - Contact Size 20 Options

Machined Contacts, Sockets & Pins				
Part Number	Description	Size	AWG	Type
AT60-010-2031	Male Contact - Pin, Gold-plated	20	16-18	Machined
AT62-005-20141	Female Contact - Socket, Gold-plated	20	16-18	Machined
AT60-010-20141	Male Contact - Pin, Nickel-plated	20	16-18	Machined
AT62-005-2031	Female Contact - Socket, Nickel-plated	20	16-18	Machined
AT60-202-2031	Male Contact - Pin, Gold-plated	20	20-22	Machined
AT62-201-2031	Female Contact - Socket, Gold-plated	20	20-22	Machined
AT60-202-20141	Male Contact - Pin, Nickel-plated	20	20-22	Machined
AT62-201-20141	Female Contact - Socket, Nickel-plated	20	20-22	Machined

Tooling - Machined Contacts		
Part	Part Number	Description
	CA-5D12	Universal Hand Crimp Tool, Size 12/16/20 (Machined contacts only)
	CA-5E12	Pneumatic Crimp Tool, Size 12/16/20 (Machined contacts only)

Contact Removal Tools		
Part	Part Number	Description
	ATRT-100	Used for removal of contacts for A Series™ products
	AT11-240-2005	Contact Removal Tool, Plastic, Size 20
	AT13-204-2005	Sealing Plug, Size 20, White

Stamped & Formed Contacts, Sockets & Pins				
Part Number	Description	Size	AWG	Type
AT60-20-0144	Male Contact - Pin, Gold-plated	20	16-22	Stamped & Formed
AT62-20-0144	Female Contact - Socket, Gold-plated	20	16-22	Stamped & Formed
AT60-20-0244	Male Contact - Socket, Gold-plated	20	16-22	Stamped & Formed
AT62-20-0244	Female Contact - Socket, Gold-plated	20	16-22	Stamped & Formed
AT60-20-0122	Male Contact - Pin, Nickel-plated	20	16-22	Stamped & Formed
AT62-20-0122	Female Contact - Socket, Nickel-plated	20	16-22	Stamped & Formed
AT60-20-0222	Male Contact - Socket, Nickel-plated	20	16-22	Stamped & Formed
AT62-20-0222	Female Contact - Socket, Nickel-plated	20	16-22	Stamped & Formed
AT60-20-0277	Male Contact - Socket, Tin-plated	20	16-22	Stamped & Formed
AT62-20-0277	Female Contact - Socket, Tin-plated	20	16-22	Stamped & Formed
AT60-20-0422	Male Contact - Socket, Nickel-plated	20	20-22	Stamped & Formed
AT62-20-0444	Female Contact - Socket, Gold-plated	20	20-22	Stamped & Formed

Tooling - Stamped & Formed Contacts		
Part	Part Number	Description
	MFX-3974	Crimp Die - Size 20 (S&F contacts only)
	MFX-3976	Crimp Die - Size 20 (S&F contacts only) 20-22AWG -04XX Series
	MFX-3978	Crimp Die - Size 20 (S&F contacts only) 20-22AWG -02XX Series
	ATT-20-00	Hand Crimp Tool - Size 20, 20AWG (S&F contacts only)

Amphenol Sine Systems
 44724 Morley Drive
 Clinton Township, MI 48036 USA
www.amphenol-sine.com
 09/2021