

Click to
ORDER
samples

AME40-277VZ



Encapsulated

The AME40-277VZ is an AC/DC converter that offers much greater cost effectiveness due to material normalization and production automation also leading to improved reliability and performance. Offering a commercial input voltage range of 85-305VAC and an output voltage range from 3.3-48V, this series will offer many benefits to your new system design.

This new series offers great operating temperatures, from -40°C to 70°C and features isolation of 4000VAC for improved reliability and system safety. Furthermore, a high MTBF of 300,000h, output short circuit protection (OSCP), output over-current protection (OCP) and an output over-voltage protection (OVP) come standard with the series.

The AME40-277VZ is suitable for street lighting controls, grid power, LED, instrumentation, industrial controls, communication and civil applications.

Features



Summary



- Universal Input: 85 - 305VAC/100 - 430VDC
- Operating Temp: -40 °C to +70 °C
- High isolation voltage: 4000VAC
- Low ripple & noise, 150mV(p-p), Max.
- Output short circuit, over-current, over-voltage protection
- Regulated Output

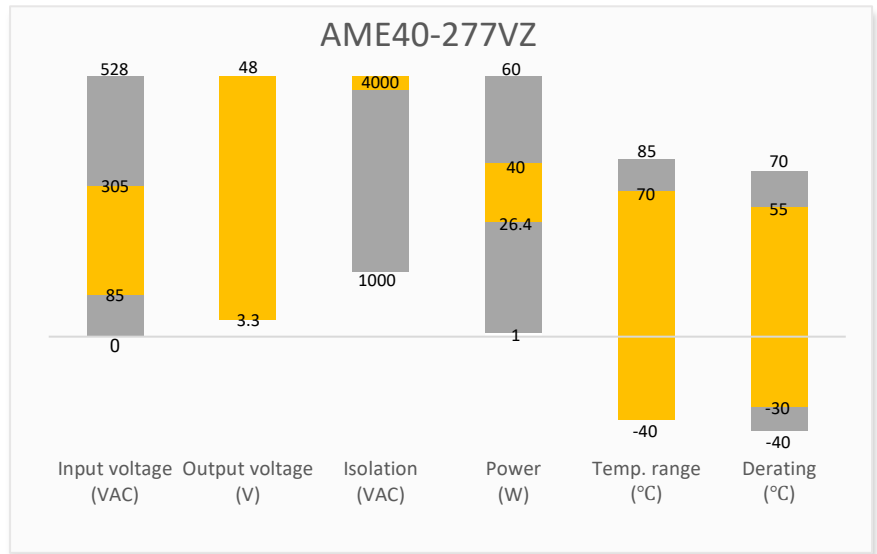

Training



Applications

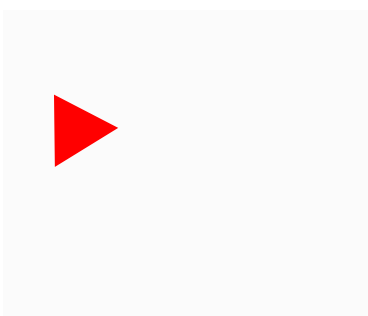

Product Training Video
(click to open)

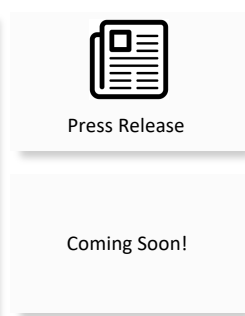

Application Notes



Power Grid



Industrial



Telecom



Instrumentation

Models & Specifications

Single Output							
Model	Input Voltage (VAC/Hz)	Input Voltage (VDC)	Max Output wattage (W)	Output Voltage (V)	Output Current max (A)	Maximum capacitive load (μF)	Efficiency @ 230VAC (%)
AME40-3S277VZ	85-305/47-63	100-430	26.4	3.3	8	60000	77
AME40-5S277VZ	85-305/47-63	100-430	40	5	8	40000	80
AME40-12S277VZ	85-305/47-63	100-430	40	12	3.33	9000	84
AME40-15S277VZ	85-305/47-63	100-430	40	15	2.66	7000	84
AME40-24S277VZ	85-305/47-63	100-430	40	24	1.67	2000	84
AME40-48S277VZ	85-305/47-63	100-430	40	48	0.83	1000	84

Note: Use suffix "ST" for chassis and suffix "STD" for DIN-Rail mounting (ex. AME40-3S277VZ-ST is chassis mounting and AME40-3S277VZ-STD is DIN-Rail mounting version).

Input Specifications				
Parameters	Conditions	Typical	Maximum	Units
Current	115VAC		1	A
	277VAC		0.6	A
Inrush current	115VAC	60		A
	230VAC	80		A
External fuse	slow blow type,300V	3.15		A

Output Specifications				
Parameters	Conditions	Typical	Maximum	Units
Voltage accuracy	3.3V / 5V output	±2	±3	%
	Others	±2		%
Line regulation	Full load	±0.5		%
Load regulation	0-100% load, 3.3V / 5V output	±1	±3	%
	0-100% load, Others	±1		%
Ripple & Noise*	20MHz bandwidth	80	150	mV p-p
Hold up time	115VAC	10		ms
	277VAC	50		ms
Voltage adjustable range			±10	%

* Ripple and Noise are measured at 20MHz bandwidth by using the referenced Application circuit.

Isolation Specifications				
Parameters	Conditions	Typical	Rated	Units
Tested I/O voltage	60 sec, leakage current < 10mA		4000	VAC

General Specifications				
Parameters	Conditions	Typical	Maximum	Units
Safety class	Class II			
Switching frequency		65		KHz
Over Current protection	Auto recovery	≥ 110		% of Iout
Over voltage protection	3.3V Vout, Voltage clamp or shut off		5.5	VDC
	5V Vout, Voltage clamp or shut off		9	VDC
	12V Vout, Voltage clamp or shut off		16	VDC
	15V Vout, Voltage clamp or shut off		24	VDC
	24V Vout, Voltage clamp or shut off		35	VDC
	48V Vout, Voltage clamp or shut off		56	VDC
Short circuit protection	Hiccup, Continuous, Auto recovery			
Operating temperature	See derating graph	-40 to +70		°C
Storage temperature		-40 to +85		°C
Lead temperature	Wave soldering	260 ± 5 °C; Maximum duration 5 - 10s		
	Hand soldering	360 ± 10 °C; Maximum duration 3 - 5s		
No-load power consumption			0.5	W
Power derating	-40 °C ~ -30 °C, 3.3V / 5V Vout	4		% / °C
	-40 °C ~ -30 °C, 12V / 15V Vout	3		% / °C
	-40 °C ~ -30 °C, 24V / 48V Vout	2		% / °C
	45 °C ~ 70 °C, 3.3V / 5V Vout	3		% / °C
	55 °C ~ 70 °C, 12V / 15V Vout	3.7		% / °C
	55 °C ~ 70 °C, 24V / 48V Vout	2.7		% / °C
	85VAC ~ 100VAC	1.33		% / VAC
	277VAC ~ 305VAC	0.72		% / VAC
Temperature coefficient		±0.02		% / °C
Cooling	Free air convection			
Humidity	Non-condensing	95		% RH
Case material	Heat resistant black Plastic (flammability to UL 94V-0)			
Weight	PCB mountable models	215		g
	With optional -ST mounting plate:	300		
	With optional -STD mounting plate:	360		
Dimensions (L x W x H)	PCB mountable models	3.50 x 2.50 x 0.98 inches (89.0 x 63.5 x 25.0mm)		
	With optional -ST mounting plate:	5.31 x 2.76 x 1.32 inches (135.0 x 70.0 x 33.5mm)		
	With optional -STD mounting plate:	5.39 x 2.76 x 1.54 inches (137.0 x 70.0 x 39.0mm)		
MTBF	> 300 000 hrs (MIL-HDBK -217F, t=+25°C)/Full Load			
NOTE: All specifications in this datasheet are measured at an ambient temperature of 25°C, humidity<75%, nominal input voltage and at rated output load unless otherwise specified.				

Safety Specifications		
Parameters		
Standards	Design to meet IEC/EN/UL 62368	
	EMC - Conducted and radiated emission	CISPR32 / EN55032, class B
	Electrostatic Discharge Immunity	IEC 61000-4-2 Contact $\pm 6\text{KV}$ / Air $\pm 8\text{KV}$, Criteria B
	RF, Electromagnetic Field Immunity	IEC 61000-4-3 10V/m, Criteria A
	Electrical Fast Transient/Burst Immunity	IEC 61000-4-4 $\pm 2\text{KV}$, Criteria B IEC 61000-4-4 $\pm 4\text{KV}$, with EMC recommended circuit, Criteria B
	Surge Immunity	IEC 61000-4-5 L-L $\pm 1\text{KV}$, Criteria B IEC 61000-4-5 L-L $\pm 2\text{KV}$ /L-G $\pm 4\text{KV}$, with EMC recommended circuit, Criteria B
	RF, Conducted Disturbance Immunity	IEC 61000-4-6 10Vr.m.s, Criteria A

Derating

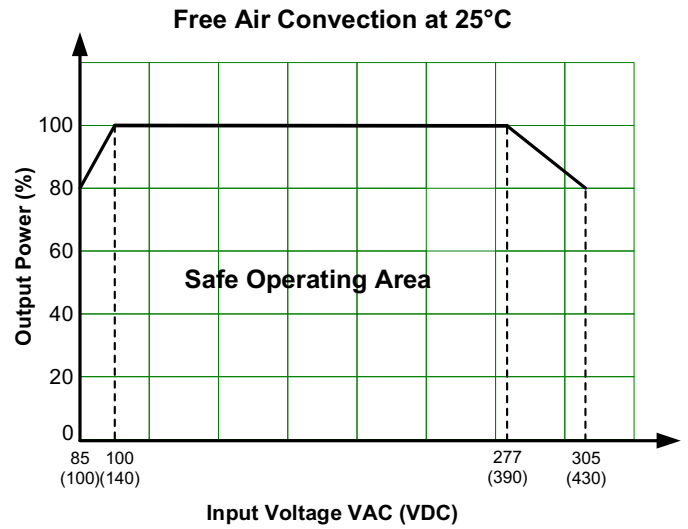
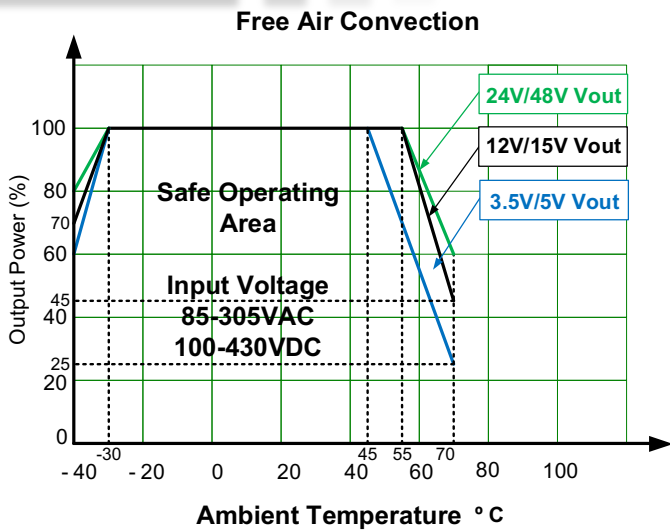

Typical Application Circuit

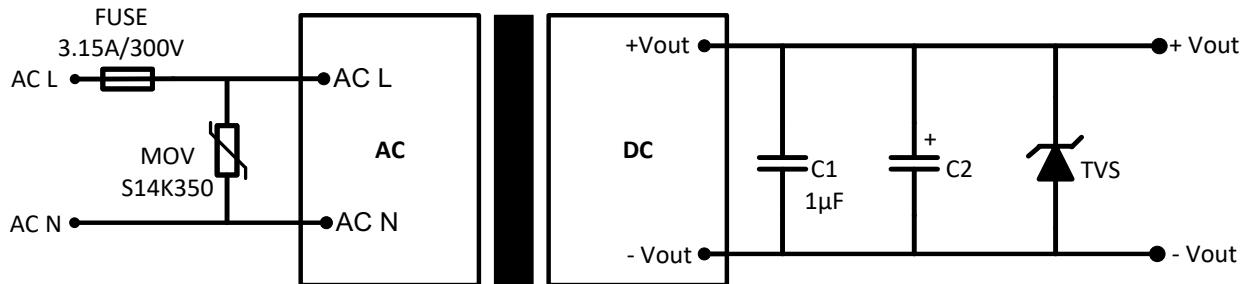

Model	C2	TVS
3.3 / 5 Vout	680 μF	SMBJ7.0A
12 / 15 Vout	220 μF	SMBJ20A
24 Vout	120 μF	SMBJ30A
48 Vout	100 μF	SMBJ64A

Note: Choose capacitors with at least 20% voltage margin.

EMC Recommended Circuit

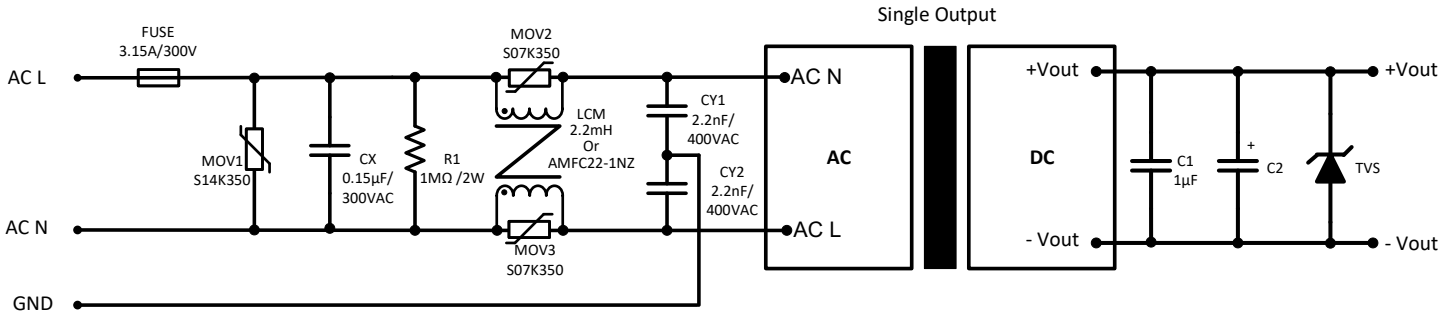

Dimensions

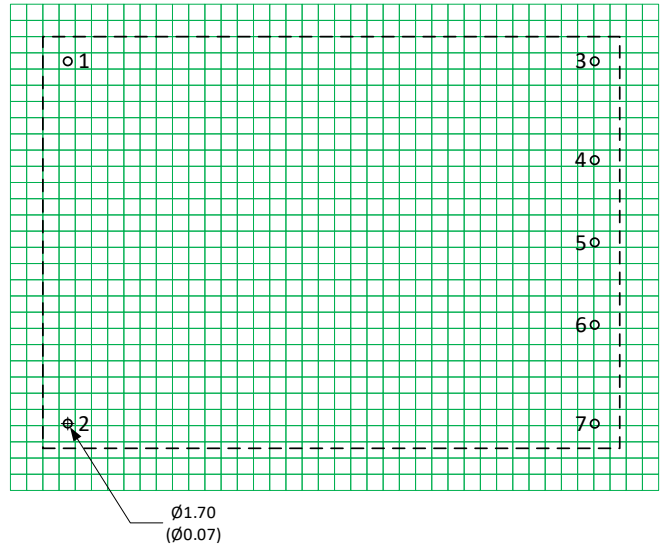
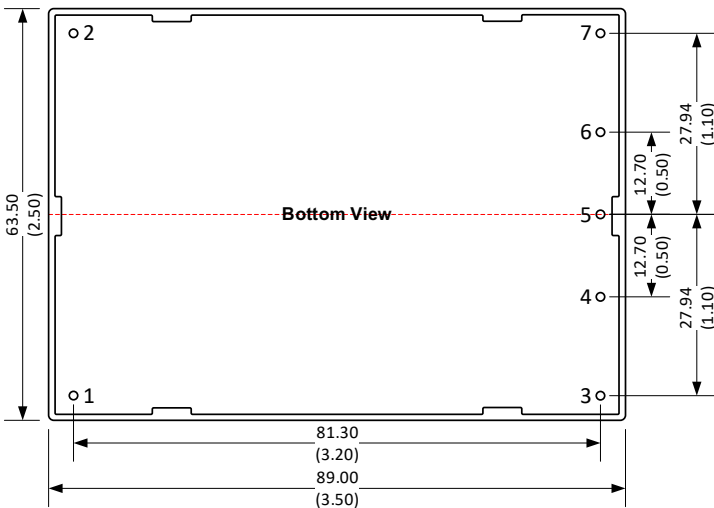

Note : Grid 2.54*2.54 mm

Notes:

All dimensions are typical in millimeters (inches).
Pin diameter tolerances : ± 0.10 (± 0.004)
General tolerance : ± 0.50 (± 0.02)

Pin Output Specifications			
Pin	Single	Pin	Single
1	AC Input (L)	5	-V Output
2	AC Input (N)	6	NC
3	+V Output	7	Trim
4	NC		

Dimensions with ST Optional

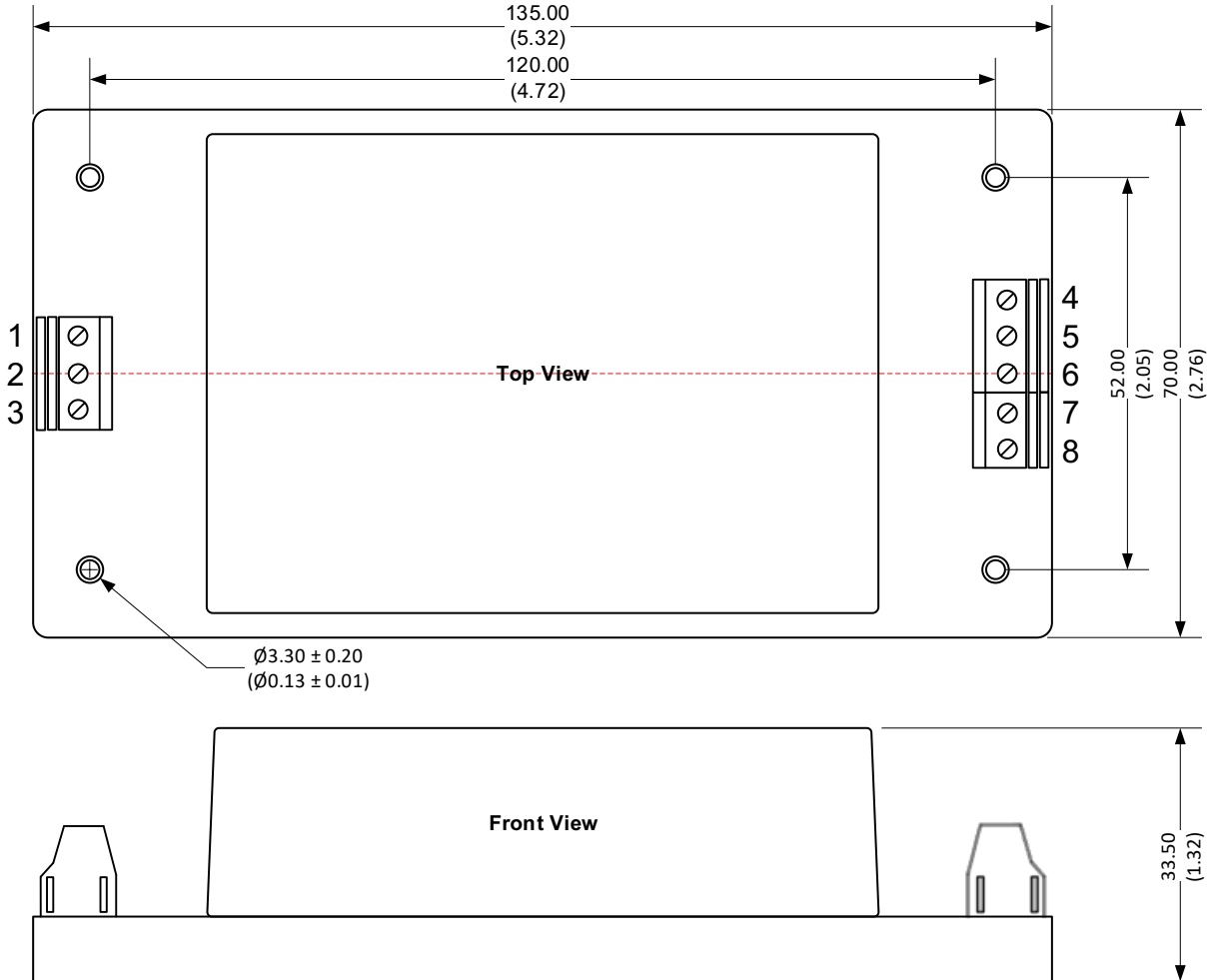
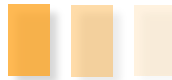

Notes:
 All dimensions are typical in millimeters (inches).
 Wire range : 24-12 AWG
 Tightening torque : Max 0.4 N.m
 General tolerance ± 1.00 : (± 0.04)

Pin Output Specifications			
Pin	Single	Pin	Single
1	AC Input (L)	5	NC
2	AC Input (N)	6	-V Output
3	NC	7	NC
4	+V Output	8	Trim

Dimensions with STD Optional

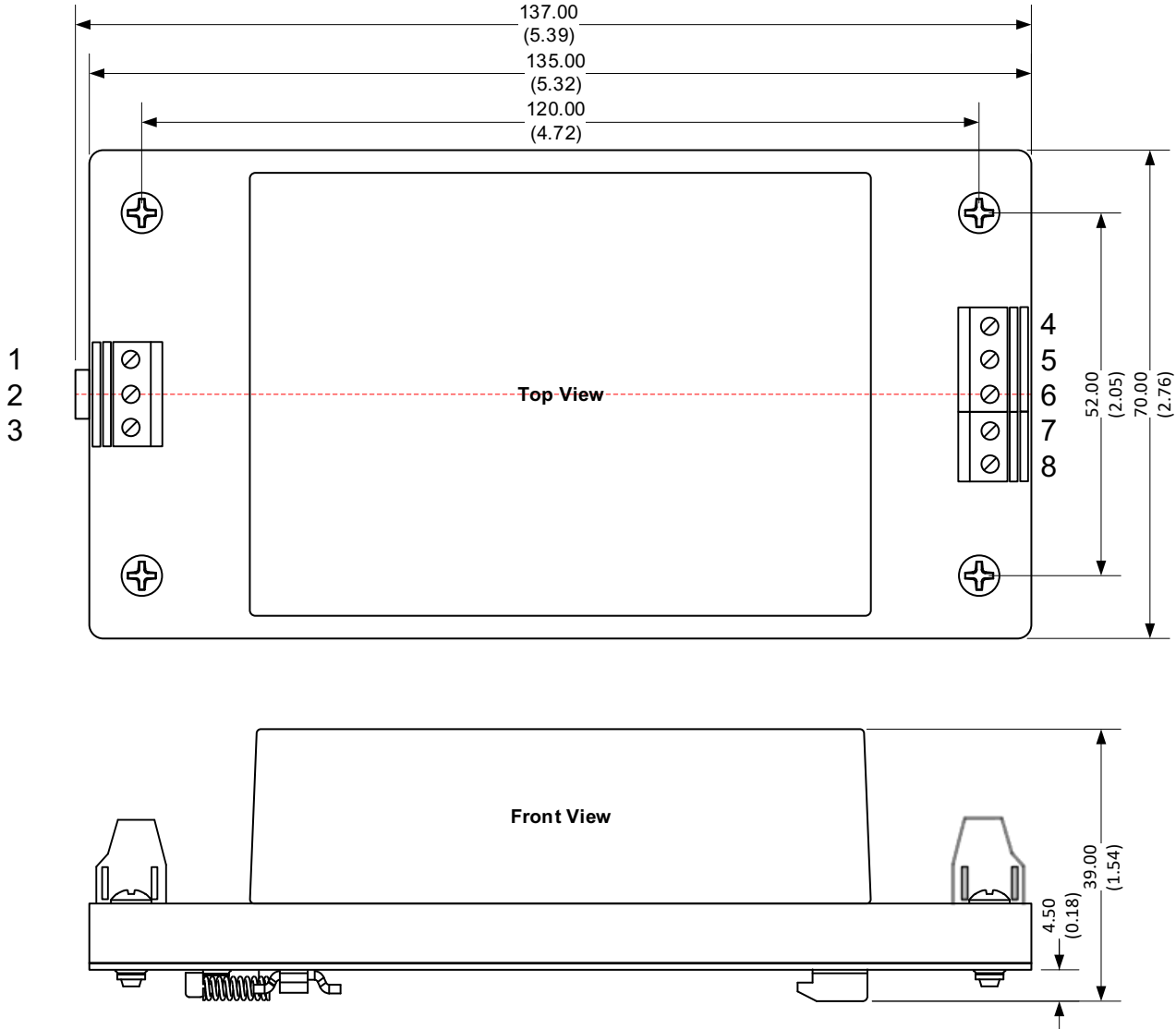

Notes:
 All dimensions are typical in millimeters (inches).
 Mounting rail : TS35, rail need to connect safety ground
 Wire range : 24-12 AWG
 Tightening torque : Max 0.4 N.m
 General tolerance ± 1.00 : (± 0.04)

Pin Output Specifications			
Pin	Single	Pin	Single
1	AC Input (L)	5	NC
2	AC Input (N)	6	-V Output
3	NC	7	NC
4	+V Output	8	Trim

Trimming

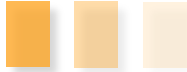

Output voltage can be externally trimmed by utilizing the methods as shown below

Fixed Resistor

Variable Potentiometer

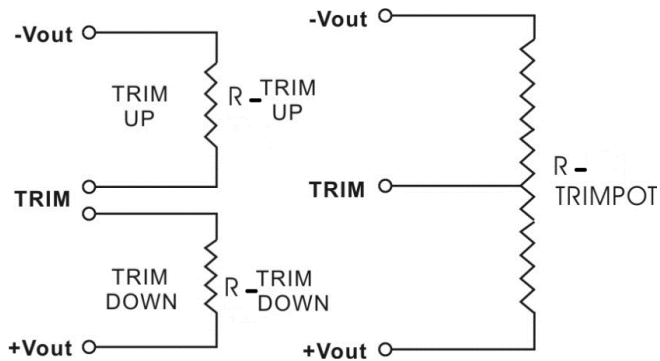

Leave open if not used.

AME40-3S277VZ

Trim down %	1	2	3	4	5	6	7	8	9	10
Vout (VDC)	3.267	3.234	3.201	3.168	3.135	3.102	3.069	3.036	3.003	2.970
Rt down (KΩ)	101.202	53.881	36.117	26.808	21.078	17.195	14.391	12.271	10.611	9.277
Trim up %	1	2	3	4	5	6	7	8	9	10
Vout (VDC)	3.333	3.366	3.399	3.432	3.465	3.498	3.531	3.564	3.597	3.630
Rt up (KΩ)	93.177	40.798	25.859	18.787	14.663	11.962	10.055	8.637	7.542	6.670

AME40-5S277VZ

Trim down %	1	2	3	4	5	6	7	8	9	10
Vout (VDC)	4.950	4.900	4.850	4.800	4.750	4.700	4.650	4.600	4.550	4.500
Rt down (KΩ)	160.700	78.200	50.700	36.950	28.700	23.200	19.271	16.325	14.033	12.200
Trim up %	1	2	3	4	5	6	7	8	9	10
Vout (VDC)	5.050	5.100	5.150	5.200	5.250	5.300	5.350	5.400	5.450	5.500
Rt up (KΩ)	164.000	81.500	54.000	40.250	32.000	26.500	22.571	19.625	17.333	15.500

AME40-12S277VZ

Trim down %	1	2	3	4	5	6	7	8	9	10
Vout (VDC)	11.880	11.760	11.640	11.520	11.400	11.280	11.160	11.040	10.920	10.800
Rt down (KΩ)	183.233	111.590	79.474	61.246	49.499	41.299	35.249	30.602	26.921	23.933
Trim up %	1	2	3	4	5	6	7	8	9	10
Vout (VDC)	12.120	12.240	12.360	12.480	12.600	12.720	12.840	12.960	13.080	13.200
Rt up (KΩ)	211.778	57.030	32.596	22.642	17.238	13.845	11.516	9.819	8.527	7.511

AME40-15S277VZ

Trim down %	1	2	3	4	5	6	7	8	9	10
Vout (VDC)	14.850	14.700	14.550	14.400	14.250	14.100	13.950	13.800	13.650	13.500
Rt down (KΩ)	616.500	304.000	199.833	147.750	116.500	95.667	80.786	69.625	60.944	54.000
Trim up %	1	2	3	4	5	6	7	8	9	10
Vout (VDC)	15.150	15.300	15.450	15.600	15.750	15.900	16.050	16.200	16.350	16.500
Rt up (KΩ)	124.000	61.500	40.667	30.250	24.000	19.833	16.857	14.625	12.889	11.500

AME40-24S277VZ

Trim down %	1	2	3	4	5	6	7	8	9	10
Vout (VDC)	23.760	23.520	23.280	23.040	22.800	22.560	22.320	22.080	21.840	21.600
Rt down (KΩ)	471.081	287.942	205.845	159.249	129.221	108.258	92.793	80.914	71.504	63.865
Trim up %	1	2	3	4	5	6	7	8	9	10
Vout (VDC)	24.240	24.480	24.720	24.960	25.200	25.440	25.680	25.920	26.160	26.400
Rt up (KΩ)	239.556	64.606	36.982	25.728	19.619	15.783	13.150	11.232	9.771	8.622

AME40-48S277VZ

Trim down %	1	2	3	4	5	6	7	8	9	10
Vout (VDC)	47.520	47.040	46.560	46.080	45.600	45.120	44.640	44.160	43.680	43.200
Rt down (KΩ)	1216.754	756.639	545.609	424.485	345.902	290.797	250.014	218.613	193.691	173.429
Trim up %	1	2	3	4	5	6	7	8	9	10
Vout (VDC)	48.480	48.960	49.440	49.920	50.400	50.880	51.360	51.840	52.320	52.800
Rt up (KΩ)	374.000	86.766	48.699	33.664	25.613	20.597	17.172	14.684	12.796	11.313

NOTE: 1. Datasheets are updated as needed and as such, specifications are subject to change without notice. Once printed or downloaded, datasheets are no longer controlled by Aimtec; refer to www.aimtec.com for the most current product specifications. **2.** Product labels shown, including safety agency certifications on labels, may vary based on the date manufactured. **3.** Mechanical drawings and specifications are for reference only. **4.** All specifications are measured at an ambient temperature of 25°C, humidity<75%, nominal input voltage and at rated output load unless otherwise specified. **5.** Aimtec may not have conducted destructive testing or chemical analysis on all internal components and chemicals at the time of publishing this document. CAS numbers and other limited information are considered proprietary and may not be available for release. **6.** This product is not designed for use in critical life support systems, equipment used in hazardous environments, nuclear control systems or other such applications which necessitate specific safety and regulatory standards other the ones listed in this datasheet. **7.** Warranty is in accordance with Aimtec's standard Terms of Sale available at www.aimtec.com.