

BU-1420721881 (CONN SMA JACK STR 50 OHM EDGE MNT)

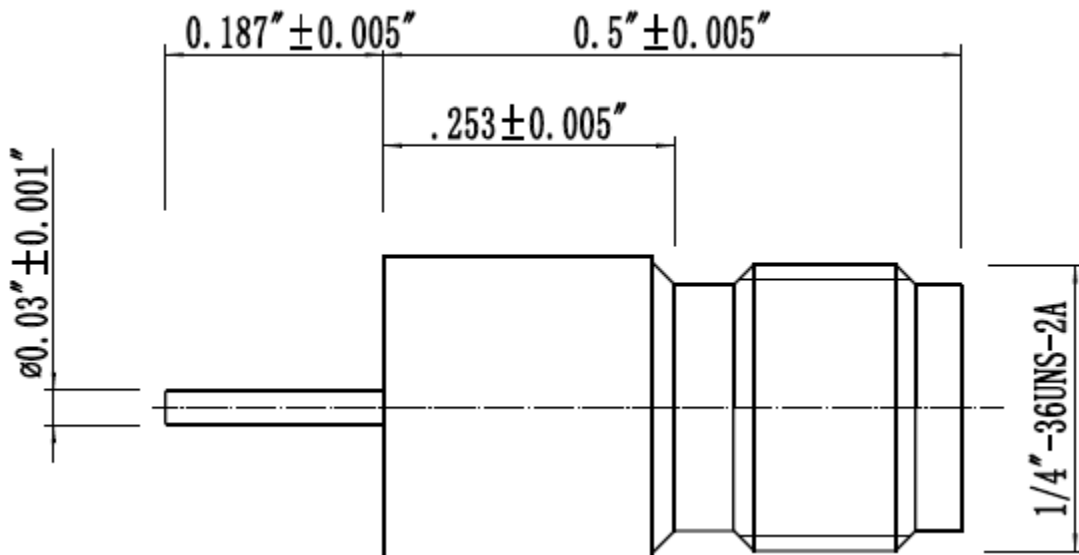

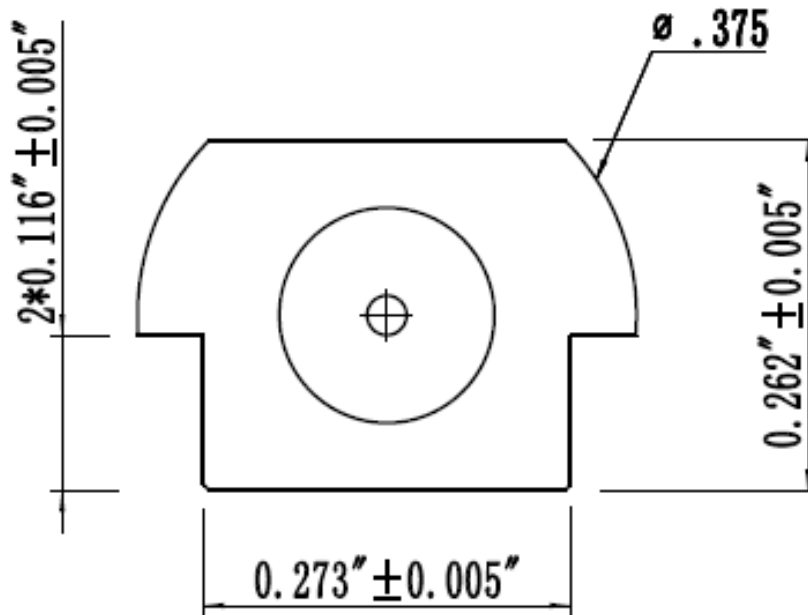

(Dimensions in Inches)

- Impedance: 50 Ohms
- Frequency Range: 0-18G
- Working Voltage: 335V at Sea Level
- Dielectric Withstanding Voltage: 1000V min at sea level
- Contact resistance: <3 milliohms
- Mating Torque: 7-10 Inch Pounds
- Material:
 - Body – 1U" Gold plated Brass
 - Contact – 5U" Gold plated Beryllium Copper
 - Insulator – Teflon
- Meets or Exceeds the applicable paragraph of MIL-C-39012
- Operating Temperature: -65°C (-85°F) to 150°C (302°F)
- RoHS 3 Compliant