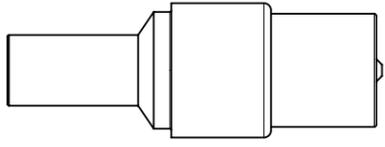
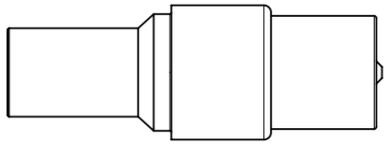
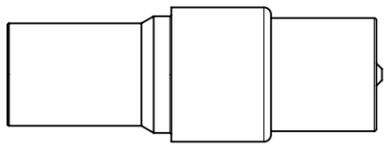
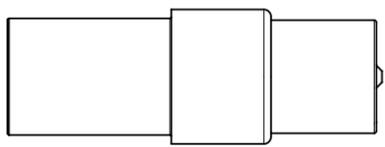
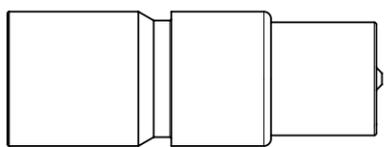

Copying of this document and giving it to others and the use or communication of the contents thereof, are forbidden without express authority. Offenders are liable to the payment of damages. All rights are reserved in the event of the grant of a patent or the registration of the utility model or design.

 Weitergabe sowie Vervielfältigung dieser Unterlage, Verwertung und Mitteilung ihres Inhalts nicht gestattet, soweit nicht ausdrücklich zugestanden. Zuwiderhandlungen verpflichten zu Schadensersatz. Alle Rechte für den Fall der Patenterteilung oder Gebrauchsmuster-Eintragung vorbehalten.

Teilenummer part number	Anschluss- querschnitt terminal cross-section	AWG AWG	Durchmesser D diameter D	Gewicht weight	Crimpzange crimp tool	Crimpbacken crimping dies
N 02 100 6119 002 	25 mm ²	4	Ø 10,0 mm	28 g	EK 12042 (Klauke) oder / or AHPW 400C (Neko)	TE 0600 042
N 02 100 6120 002 	35 mm ²	2	Ø 12,5 mm	28 g		TE 0600 022
N 02 100 6121 002 	50 mm ²	1	Ø 14,5 mm	36 g		TE 0500 103
N 02 100 6122 002 	70 mm ²	00	Ø 16,5 mm	38 g		TE 0500 201
N 02 100 6123 002 	95 mm ²	000	Ø 19,0 mm	51 g		TE 0500 301

Steckzyklen / mating cycles ≥500
Material / material: CuZn

Oberflächenbeschichtung / surface plating: Ag
Abisolierlänge / stripping length: 18,5

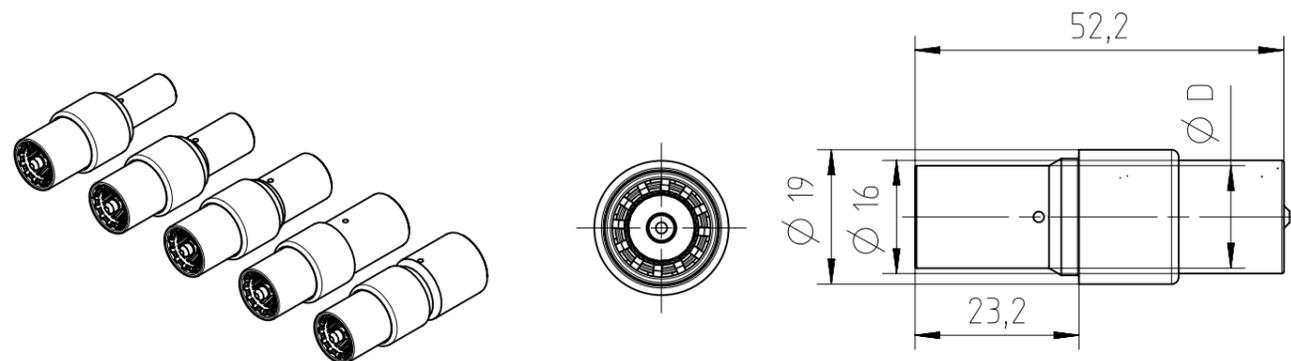

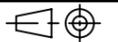
Gewicht (errechnet) / Calc WT:		Zul. Abw./Tolerances:		Maßstab / Scale: 1:1 (1:2)	A3	
Prüfmaß / Testdimension		ISO 2768-m		CUSTOMER DRAWING		
Teileindex / Partindexnumber:		DIN / ISO 13715		Buchsenkontakt socket contact		
Bagatelle change: 16.10.2017 PWÖELFFLE						
Gez. / Drawn	10.05.2017 PWÖELFFLE	Status / Released		M N 02 100 61XX 002		
Gepr. / Checked	28.08.2017 MGRIMM	Status / Released				
Index		Änderung / Description		Date / Datum		Name
02	201700316	16.08.2017	PWÖLF	Amphenol Tuchel Industrial GmbH		Blatt / Sheet 1
01	201700151	10.05.2017	PWÖLF			1 Bl.
Ers. f. / Replacement for:						

FAI2017-000485
NXM-V01