

USB-1608FS

Simultaneous USB DAQ Device



The USB-1608FS features simultaneous sampling of 8 analog inputs, and also provides 8 DIO lines and a 32-bit event counter

Features

- Eight single-ended analog inputs
- 16-bit resolution
- Simultaneous sampling
- 100 kS/s aggregate sample rate (50 kS/s max for any channel)
- Eight digital I/O
- 32-bit event counter
- External clock I/O
- External digital trigger input

Supported Operating Systems

- Windows® 10/8/7/Vista®/XP 32/64-bit
- Linux®

Overview

The USB-1608FS device provides simultaneous sampling with a sample rate of 50 kS/s maximum for any one channel, and up to 100 kS/s aggregate for multiple channels. The device also features a 32-bit event counter, 8 digital I/O lines, external digital triggering, and a bidirectional clock. An OEM version is available for embedded applications.

Analog Input

The USB-1608FS has a dedicated A/D converter per analog channel for simultaneous sampling. It offers software-selectable analog input ranges for ± 10 V, ± 5 V, ± 2 V, and ± 1 V.

Simultaneous Sampling

Each analog input channel has a dedicated 16-bit A/D converter for true simultaneous sampling of all 8 inputs.

Sample Rates

With hardware paced mode, the maximum throughput rate is 50 kS/s for any one channel, up to 100 kS/s maximum aggregate for multiple channels.

Use burst scan mode to run any number of channels at the maximum rate of 50 kS/s up to the full capacity of the 32K sample FIFO. The maximum sampling rate is 200 kS/s aggregate for all channels.

Channel-Gain Queue

The channel-gain queue lets you configure a list of channels and gains for each scan. Each channel can have a different gain setting. The gain settings are stored in a channel-gain queue list that is written to local memory on the device.

The channel-gain queue can contain up to eight unique, consecutive channels listed in increasing order.

Digital I/O

Each of the eight digital I/O channels is individually-configurable for input or output. When configured for input, the digital I/O terminals can detect the state of any TTL-level input.

Pull-Up/Down Configuration

The USB-1608FS has a user-configurable internal jumper to configure the digital bits for pull-up (default) or pull-down.

Counter Input

The USB-1608FS has a 32-bit event counter that can accept a signal up to 1 MHz. The internal counter increments when the TTL levels transition from low to high.

External Clock I/O

Each USB-1608FS has a bidirectional external clock terminal. When configured for input, A/D conversions can be paced by an external source.

The USB-1608FS supports TTL-level input signals up to 50 kHz.

When configured for output, the USB-1608FS can pace A/D conversions on a second device and acquire data from all input channels simultaneously.

Trigger Input

The USB-1608FS provides an external digital trigger input and a trigger mode that is edge sensitive and software-selectable for rising or falling edge.

Calibration

The USB-1608FS is factory-calibrated using a NIST-traceable calibration process. Specifications are guaranteed for one year.

The USB-1608FS also supports field calibration for users to calibrate the device locally with the InstaCal utility.





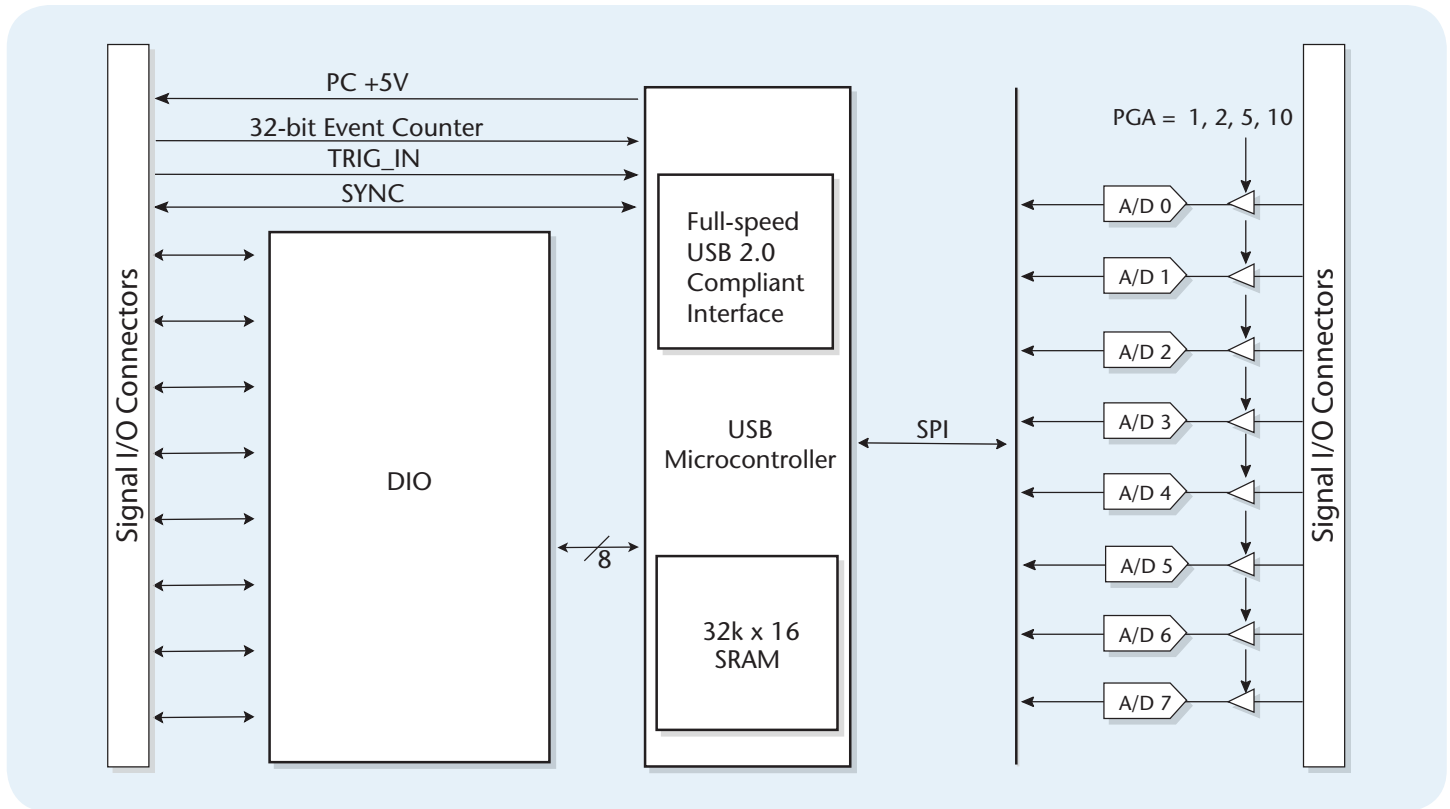

USB-1608FS

Block Diagram

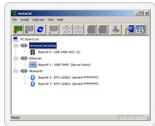

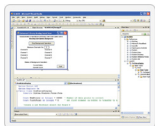
Software Support

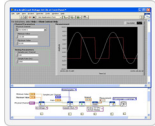
The USB-1608FS device is supported by the software in the table below.

Ready-to-Run Applications	
DAQami™	 <p>Data acquisition companion software with drag-and-drop interface that is used to acquire, view, and log data, and generate signals. DAQami can be configured to log analog, digital, and counter channels, and to view that data in real-time or post-acquisition on user-configurable displays. Logged data can be exported for use in Excel® or MATLAB®. Windows OS</p> <p>DAQami is included with the free MCC DAQ Software bundle (CD/download). Install DAQami and try the fully-functional software for 30 days. After 30 days, all features except for data logging and data export will continue to be available – data logging and data export features can be unlocked by purchasing the software.</p>
InstaCal™	 <p>An interactive installation, configuration, and test utility for MCC hardware. Windows OS</p> <p>InstaCal is included with the free MCC DAQ Software bundle (CD/download).</p>
TracerDAQ™ and TracerDAQ Pro	 <p>Virtual strip chart, oscilloscope, function generator, and rate generator applications used to generate, acquire, analyze, display, and export data. Supported features may vary by hardware. The Pro version provides enhanced features. Windows OS</p> <p>TracerDAQ is included with the free MCC DAQ Software bundle (CD/download).</p> <p>TracerDAQ Pro is available as a purchased software download.</p>
General-Purpose Programming Support	
Universal Library™ (UL)	 <p>Library for developing applications in C, C++, VB, C# .Net, VB .Net, and Python. Windows OS</p> <p>The UL is included with the free MCC DAQ Software bundle (CD/download).</p>
Linux® driver	 <p>Open-source Linux drivers are available for most MCC devices. Example programs are also provided.</p>
Application-Specific Programming Support	
ULx for NI LabVIEW™	 <p>A comprehensive library of VIs and example programs for NI LabVIEW that is used to develop custom applications that interact with most MCC devices. Windows OS</p> <p>ULx for NI LabVIEW is included with the free MCC DAQ Software bundle (CD/download).</p>
DASYLab®	 <p>Icon-based data acquisition, graphics, control, and analysis software that allows users to create complex applications in minimal time without text-based programming. Windows OS</p> <p>DASYLab is available as a purchased software download. An evaluation version is available for 28 days.</p>
MATLAB® driver	 <p>High-level language and interactive environment for numerical computation, visualization, and programming. The Mathworks Data Acquisition Toolbox™ allows users to acquire data from most MCC PCI and USB devices.</p> <p>Visit www.MathWorks.com for more information about the Data Acquisition Toolbox.</p>

USB-1608FS

Specifications



Specifications

All specifications are subject to change without notice. Typical for 25 °C unless otherwise specified.

Analog Input

A/D converter type: 16-bit successive approximation type
Channels: 8 single-ended
Input configuration: Individual A/D per channel
Sampling method: Simultaneous
Absolute maximum input voltage (CHx IN relative to GND): ±15 V max
Input impedance: 100 MΩ min
Input ranges: ±10 V, ±5 V, ±2 V, ±1 V; software-selectable per channel
Sample rate (hardware paced): 0.6 S/s to 50 kS/s, software-selectable
Throughput
Software paced: 500 S/s all channels
Hardware paced (system-dependent): (100 kS/s)/(# of channels) max, 50 kS/s max for any channel
Burst scan ≤ 32,768 total samples (uses onboard FIFO):
 (200 kS/s)/(# of channels) max, 50 kS/s max for any channel
Gain queue: Up to eight elements; one gain element per unique, consecutive channel; software-selectable
Resolution: 16 bits
No missing codes: 15 bits
Crosstalk (signal DC to 25 kHz): -80 dB
CAL output: 0.625 V, 1.25 V, 2.5 V, 5 V
CAL output accuracy: 0.5% typ, 1.0% max (actual values used for calibration are measured and stored in EEPROM)
CAL current: ±5 mA max
Trigger source (software-selectable): External digital - TRIG_IN

Accuracy

Calibrated Absolute Accuracy	
Range	Accuracy
±10 V	5.66 mV
±5 V	2.98 mV
±2 V	1.31 mV
±1 V	0.68 mV

Accuracy Components – all values are (±)			
Range	Gain Error (% of Reading)	Gain Error at Full Scale	Offset
±10 V	0.04	4.00 mV	1.66 mV
±5 V	0.04	2.00 mV	0.98 mV
±2 V	0.04	0.80 mV	0.51 mV
±1 V	0.04	0.40 mV	0.28 mV

Noise Performance*		
Range	Typical Counts	Least Significant Bit <small>Root Mean Square</small> (LSB _{RMS})
±10 V	10	1.52
±5 V	10	1.52
±2 V	11	1.67
±1 V	14	2.12

* Noise distribution is determined by gathering 50 kS with inputs tied to ground at the user connector. Samples are gathered at the maximum specified sample rate of 50 kS/s per channel.

Digital Input/Output

Digital type: CMOS
Number of I/O: 8 (DIO0 through DIO7)
Configuration: Independently configured for input or output
Pull-up/pull-down configuration: All pins pulled up to 5 V via 47 kΩ resistors (default). Hardware revisions E and later have a user-configurable jumper.
Input high voltage threshold: 2.0 V min
Input high voltage limit: 5.5 V absolute max
Input low voltage threshold: 0.8 V max
Input low voltage limit: -0.5 V absolute min; 0 V recommended min
Output high voltage (IOH = -2.5 mA): 3.8 V min
Output low voltage (IOL = 2.5 mA): 0.44 V max
Power on and reset state: Input

External Trigger

Trigger source: External digital: TRIG_IN
Trigger mode (software-selectable): Edge sensitive: user configurable for CMOS compatible rising or falling edge
Trigger latency: 10 μs max
Trigger pulse width: 1 μs min
Input type: Schmitt trigger, 47 kΩ pull-down to ground
Schmitt trigger hysteresis: 1.01 V typ, 0.6 V min, 1.5 V max
Input high voltage threshold: 2.43 V typ, 1.9 V min, 3.1 V max
Input high voltage limit: 5.5 V absolute max
Input low voltage threshold: 1.42 V typ, 1.0 V min, 2.0 V max
Input low voltage limit: -0.5 V absolute min, 0 V recommended min

External Clock I/O

Pin name: SYNC
Pin type: Bidirectional
Direction (software-selectable)
Input: Receives A/D pacer clock from external source;
Output: Outputs internal A/D pacer clock
Input clock rate: 50 kHz max
Clock pulse width: 1 μs min input, 5 μs min output
Input clock mode: Edge sensitive, rising edge
Input type: Schmitt trigger, 47 kΩ pull-down to ground
Schmitt trigger hysteresis: 1.01 V typ, 0.6 V min, 1.5 V max
Input high voltage threshold: 2.43 V typ, 1.9 V min, 3.1 V max
Input high voltage limit: 5.5 V absolute max
Input low voltage threshold: 1.42 V typ, 1.0 V min, 2.0 V max
Input low voltage limit: -0.5 V absolute min, 0 V recommended min
Output high voltage: 4.4 V min (IOH = -50 μA), 3.80 V min (IOH = -8 mA)
Output low voltage: 0.1 V max (IOL = 50 μA), 0.44 V max (IOL = 8 mA)

Counter

Pin name: CTR
Counter type: Event counter
Number of channels: 1
Input type: Schmitt trigger, 47 kΩ pull-down to ground
Input Source: CTR screw terminal
Resolution: 32 bits
Schmitt trigger hysteresis: 1.01 V typ, 0.6 V min, 1.5 V max
Input high voltage threshold: 2.43 V typ, 1.9 V min, 3.1 V max
Input high voltage limit: 5.5 V absolute max
Input low voltage threshold: 1.42 V typ, 1.0 V min, 2.0 V max
Input low voltage limit: -0.5 V absolute min, 0 V recommended min
Input Frequency: 1 MHz max
High pulse width: 500 ns min
Low pulse width: 500 ns min

Power

Supply Current
USB enumeration: < 100 mA
Including DIO and SYNC output loading: < 500 mA
+5 V USB power available (connected to externally-powered root port hub or a self-powered hub): 4.5 V min, 5.25 V max
Output current (total amount of current that can be sourced from the USB +5 V and digital outputs): 300 mA max

USB

Device type: USB 2.0 (full-speed)
Device compatibility: USB 1.1, USB 2.0

USB-1608FS

Ordering



Environmental

Operating temperature range: 0 °C to 70 °C

Storage temperature range: -40 °C to 70 °C

Humidity: 0% to 90% non-condensing

Mechanical

Dimensions (L × W × H): 79 × 82 × 27 mm (3.10 × 3.20 × 1.05 in.)

USB cable length: 3 m (9.84 ft) max

User connection length: 3 m (9.84 ft) max

Order Information

Hardware

Part No.	Description
USB-1608FS	USB-based DAQ device with 8 simultaneous 16-bit 100 kS/s/ch analog inputs and 8 digital I/O. Includes a USB cable and MCC DAQ software.

Software also Available from MCC

Part No.	Description
DAQami	Data acquisition companion software for acquiring data and generating signals
TracerDAQ Pro	Out-of-the-box virtual instrument suite with strip chart, oscilloscope, function generator, and rate generator – professional version
DASYLab	Icon-based data acquisition, graphics, control, and analysis software