

Product information

92 38 75 ESD

Universal Tweezers ESD

DIN EN 61340 -5-1



- Electrically dissipative coating: Universal tweezers in the ESD version equalize differences in electrical potential between their user and the workpieces in a controlled manner
- ESD-tested, black epoxy resin coating with a surface resistance between 10^4 and 10^9 ohms
- For the electronics and precision engineering industries
- Antimagnetic to avoid electromagnetic damage
- Wide range of designs: straight, angled, gripping surfaces and handles smooth or serrated, with needle points, narrow or blunt tips
- The high quality stainless steel ensures extreme toughness and very good corrosion resistance against a variety of atmospheric environments and many corrosive materials
- Also available as a set (92 00 01 ESD)
- Stainless steel

General

Article No.	92 38 75 ESD
EAN	4003773054863
Material	stainless steel
Gripping surfaces	smooth gripping surfaces
Weight	15 g
Dimensions	118 x 10 x 12 mm
Standard	DIN EN 61340 -5-1
Reach	no
RohS	no

Technical details

Tips width (A)	0.25 mm
Tips width (B)	0.3 mm
Corrosion-resistant	yes
	yes
VDE tested	no
sectors	electronics

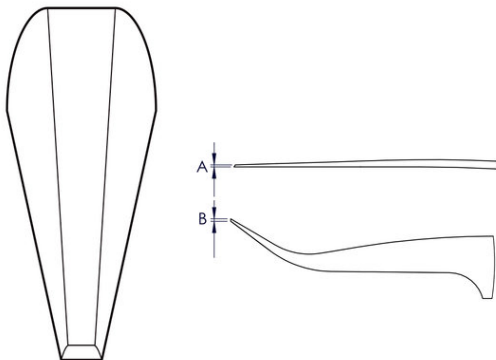



Classification	
eCl@ss 5.1.4	21040500
ETIM 5.0	EC000182
ETIM 6.0	EC000182
proficl@ss 6.0	EAB696c019
UNSPSC 13.1	27112149

technical change and errors excepted