

SERIES: PRFE20W-D | DESCRIPTION: DC-DC CONVERTER
FEATURES

- 20 W isolated output
- ultra-wide 18:1 input range
- single/dual regulated outputs
- UL/EN 62368 certified
- meets EN 55032/55035/50155 with external circuits
- 3000 Vdc isolation
- remote on/off
- wide operating temperature range (-40~105°C)



MODEL	input voltage		output voltage	output current	output power	ripple & noise ¹ Vo1/Vo2	efficiency ²
	nom (Vdc)	range (Vdc)	(Vdc)	max (A)	max (W)	max (mVp-p)	typ (%)
PRFE20W-072-S5-D	72	8.5~160	5	4.00	20	75	86
PRFE20W-072-S12-D	72	8.5~160	12	1.67	20	100	89
PRFE20W-072-S15-D	72	8.5~160	15	1.33	20	100	89
PRFE20W-072-D12-D	72	8.5~160	±12	±0.83	20	100	89
PRFE20W-072-D15-D	72	8.5~160	±15	±0.66	20	100	89
PRFE20W-072-D24-D	72	8.5~160	±24	±0.41	20	100	90

Notes: 1. Peak to peak, 5Hz to 20MHz bandwidth, full load, 22µF aluminum solid capacitor and 1µF ceramic capacitor.
 2. 72Vdc input voltage.

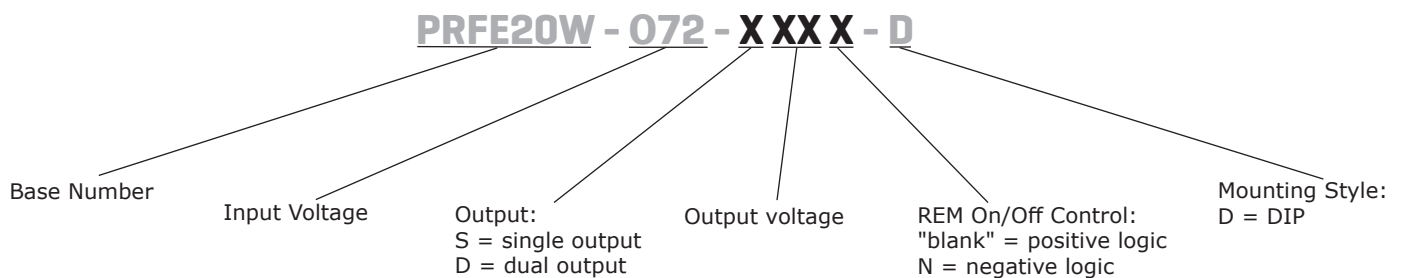
PART NUMBER KEY

INPUT

parameter	conditions/description	min	typ	max	units
input voltage		8.5		160	Vdc
surge voltage	for maximum of 0.1 second			200	Vdc
current	at 12 Vdc input voltage, full load			2.2	A
inrush current				0.1	A ² s
filter	Pi filter				
remote on/off ³	positive logic	models ON (>4.0 Vdc or REM pin open circuit)			
		models OFF (REM pin 0~1.2 Vdc)			
	negative logic	models ON (REM pin 0~1.2 Vdc)			
		models OFF (>4.0 Vdc or REM pin open circuit)			
under voltage lockout	turn on	8.5		9.5	V
	turn off	7		8	V

Notes: 3. - Voltages referenced to -Vin pin.

OUTPUT

parameter	conditions/description	min	typ	max	units
maximum capacitive load	5 Vdc output model			6,800	μF
	12 Vdc output model			3,300	μF
	15 Vdc output model			2,200	μF
	±12 Vdc output model			820	μF
	±15 Vdc output model			680	μF
	±24 Vdc output model			330	μF
voltage accuracy	at 72 Vdc input voltage, full load, 25°C			±1.0	%
line regulation	from low line to high line, full load			±0.2	%
load regulation	from full load to no load				
	single output			±0.2	%
	double output			±1.0	%
switching frequency	output ripple frequency		200		kHz
transient recovery time	75% ~ 100%, nominal input voltage			250	μs
transient response deviation	75% ~ 100%, nominal input voltage			±5	%
temperature coefficient	40°C ~ 105°C			±0.02	%/°C
adjustability	single output				
	output power ≤ max. rated power, via trim pin	-20		15	%

PROTECTIONS

parameter	conditions/description	min	typ	max	units
over current protection	auto recovery, hiccup	110		180	%
over voltage protection	5 Vdc output model, zener clamp		6.2		Vdc
	12 Vdc output model, zener clamp		15		Vdc
	15 Vdc output model, zener clamp		18		Vdc
	±12 Vdc output model, zener clamp		±15		Vdc
	±15 Vdc output model, zener clamp		±18		Vdc
	±24 Vdc output model, zener clamp		±30		Vdc
over temperature protection	shutdown		110		°C
	recovery		92		°C
short circuit protection	continuous, auto recovery				

SAFETY AND COMPLIANCE

parameter	conditions/description	min	typ	max	units
isolation voltage	input to output, for 2 seconds			3,000 4,200	Vac Vdc
isolation resistance	input to output	1,000			MΩ
isolation capacitance	input to output; output to case		20		pF
safety approvals	certified to 62368: UL/EN/IEC				
conducted emissions	EN 55032 & EN 50155 Class A (with external filter)				
radiated emissions	EN 55032 & EN 50155 Class A (with external filter)				
ESD	EN 61000-4-2 Level 3: Air ±8kV, Contact ±6kV Perf. Criteria A				
radiated immunity	EN 61000-4-3 Level 3: 80~1000MHz, 20V/m Perf. Criteria A				
EFT/burst	EN 61000-4-4 Level 3: On power input port, ±2kV, external input capacitor required (EN 50155); Level 4: On power input port, ±4kV, external input capacitor required (EN 55035) Perf. Criteria A				
surge	EN 61000-4-5 Level 4: Line to earth, ±4kV, Line to line, ±2kV (EN 50155); Level 4: Line to earth, ±4kV, Line to line, ±2kV (EN 55035) Perf. Criteria A				
conducted immunity	EN 61000-4-6 Level 3: 0.15~80MHz, 10V Perf. Criteria A				
magnetic immunity	EN 61000-4-8 Level 1: 50Hz, 1A/m for EN 55035:2017 Perf. Criteria A				
voltage dips and interruption	EN 50155 Class S3: 20ms interruptions Perf. Criteria A				
MTBF	as per MIL-HDBK-217F, 25°C				
	5 Vdc output model		1,242		kHours
	12 Vdc output model		1,397		kHours
	15 Vdc output model		1,631		kHours
	24 Vdc output model		1,341		kHours
RoHS	yes				

ENVIRONMENTAL

parameter	conditions/description	min	typ	max	units
operating case temperature	see derating curve	-40		105	°C
storage temperature		-55		125	°C
storage humidity	non-condensing	-		95	%

MECHANICAL

parameter	conditions/description	min	typ	max	units
dimensions	2.00 × 1.00 × 0.40 [50.8 × 25.4 × 10.2 mm]				inch
case material	plastic, DAP, UL 94V-0				
weight			28.5		g

MECHANICAL DRAWING

units: inch [mm]

tolerances: inch: x.xx = ±0.02, x.xxx = ±0.010

mm: x.x = ±0.5, x.xx = ±0.25

pin diameter: 0.04 ±0.004 inch [1.0 ±0.1 mm]

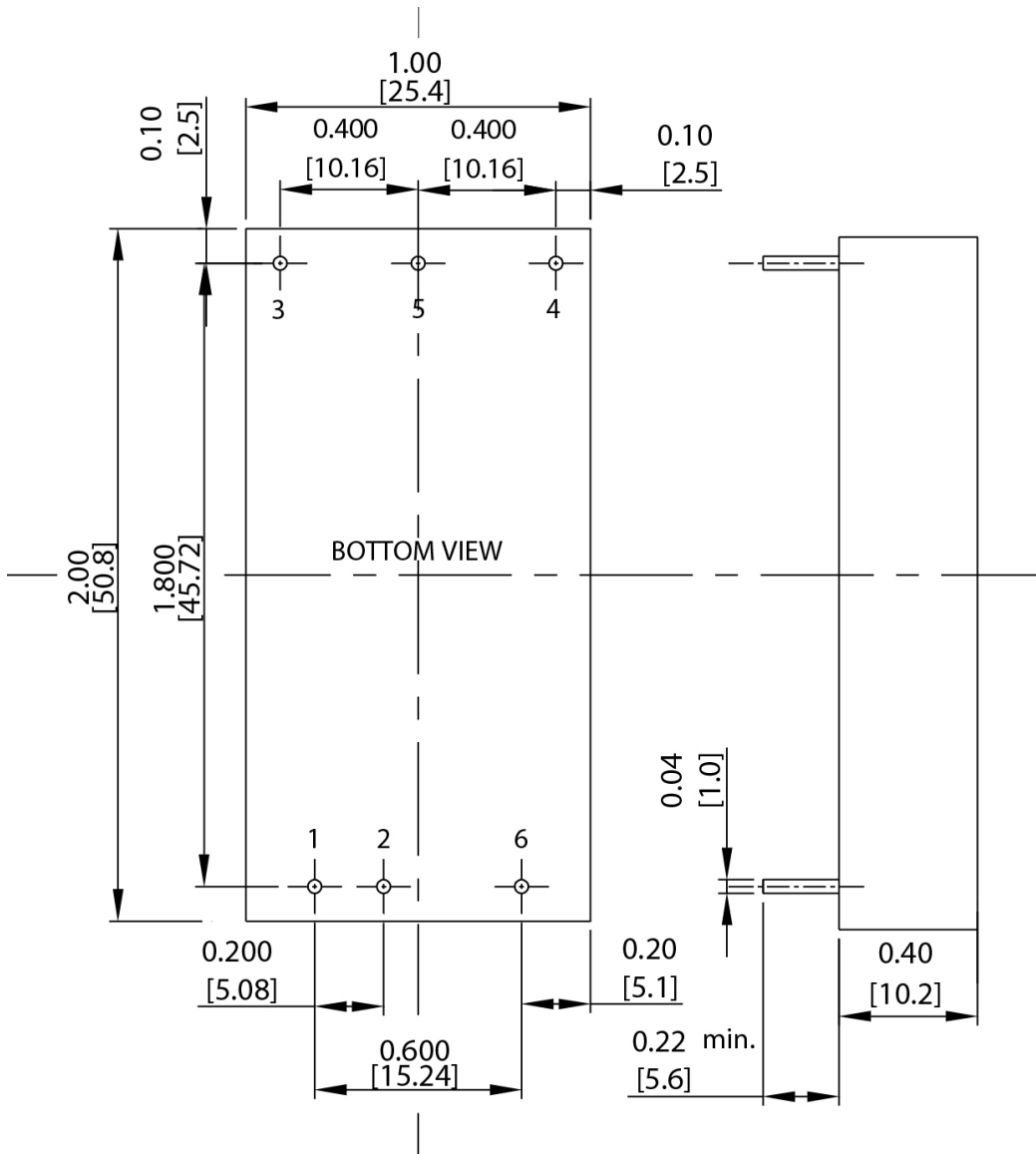

PIN	PIN Out	
	Single output Function	Dual output Function
1	+Vin	+Vin
2	-Vin	-Vin
3	+Vo	+Vo
4	Trim	-Vo
5	-Vo	Common
6	Remote	Remote

DERATING CURVES

TEMPERATURE DERATING CURVE

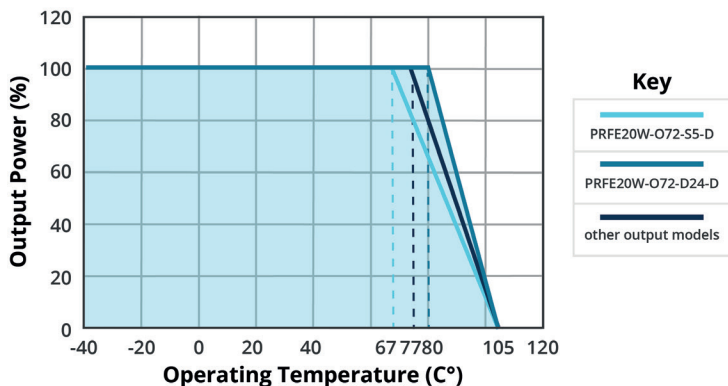

INPUT VOLTAGE DERATING CURVE (25°C)

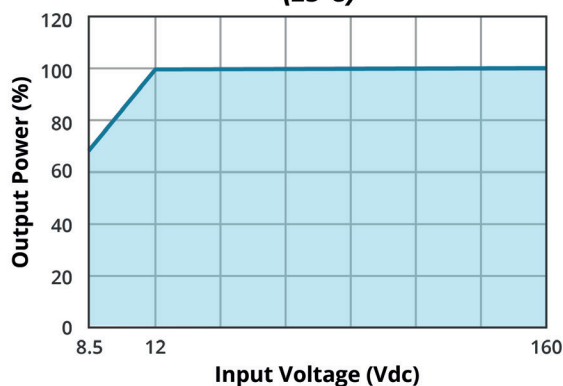

EFFICIENCY CURVES

EFFICIENCY VS OUTPUT CURRENT PRFE20W-072-S5-D (25°C)

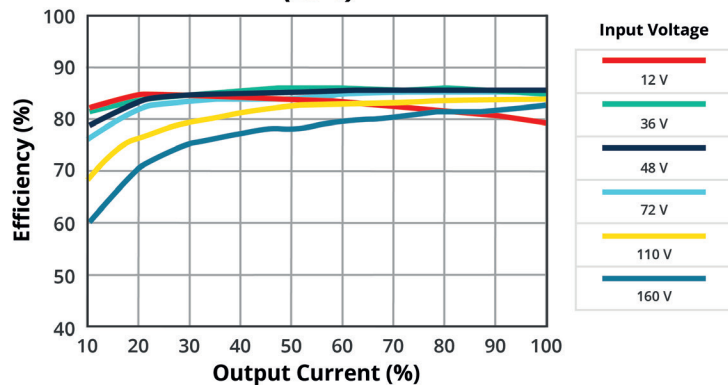

POWER DISSIPATION VS OUTPUT POWER PRFE20W-072-S5-D (25°C)

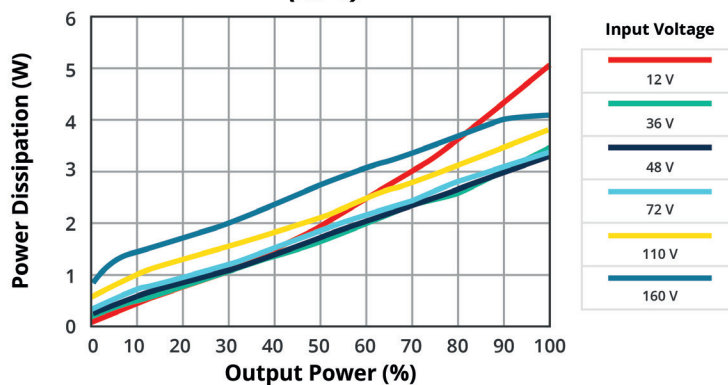

EFFICIENCY VS OUTPUT CURRENT PRFE20W-072-S12-D (25°C)

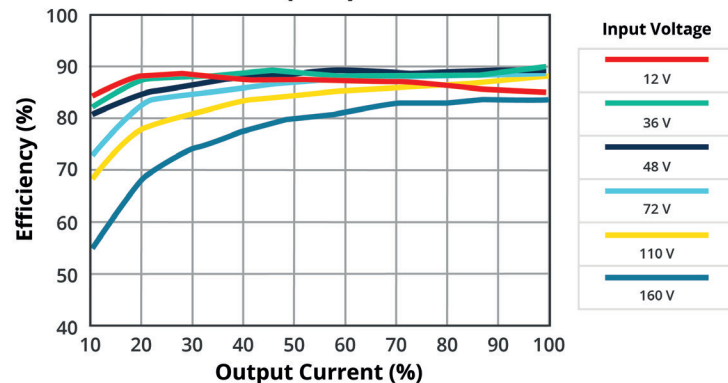

POWER DISSIPATION VS OUTPUT POWER PRFE20W-072-S12-D (25°C)

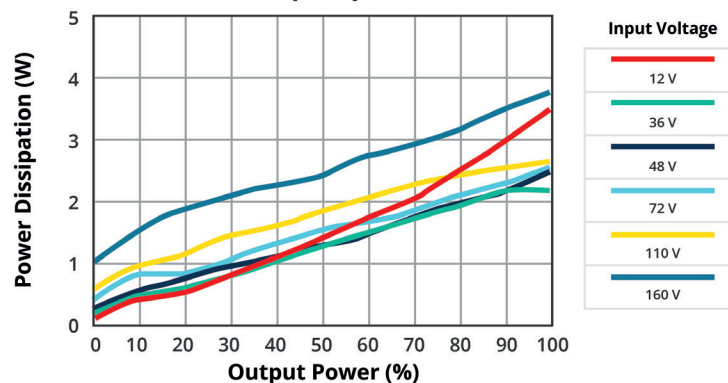

EFFICIENCY CURVES (CONTINUED)

EFFICIENCY VS OUTPUT CURRENT
PRFE20W-072-S15-D
(25°C)

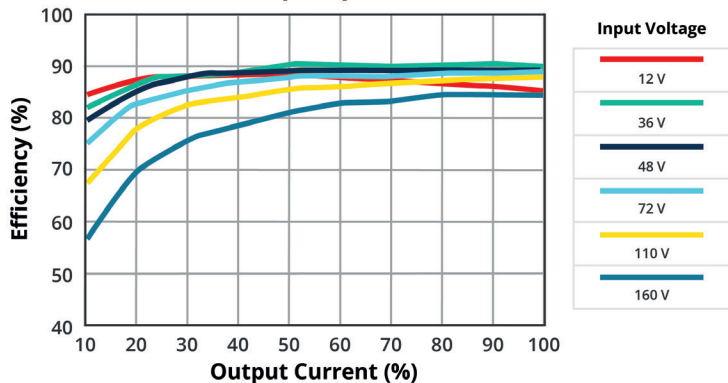

POWER DISSIPATION VS OUTPUT POWER
PRFE20W-072-S15-D
(25°C)

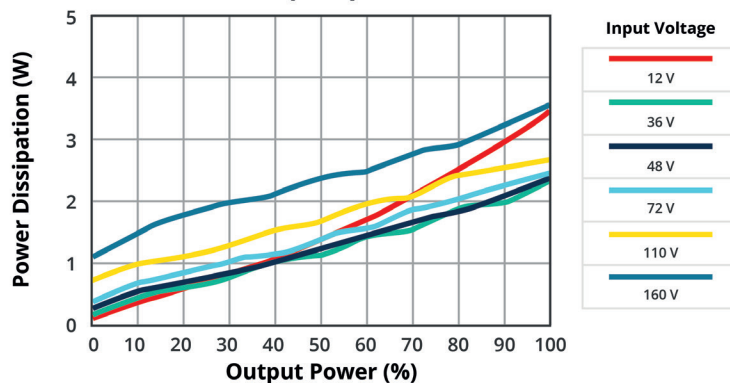

EFFICIENCY VS OUTPUT CURRENT
PRFE20W-072-D12-D
(25°C)

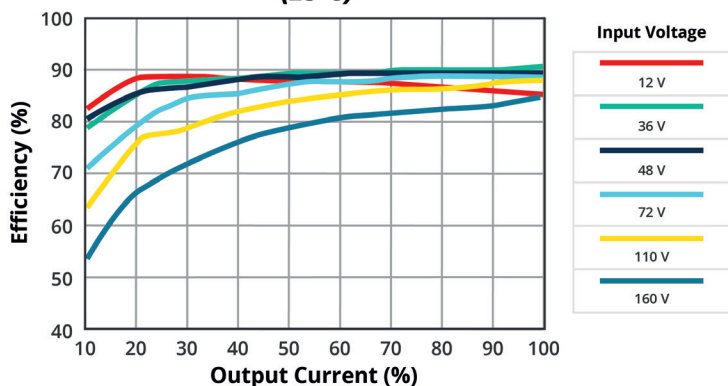

POWER DISSIPATION VS OUTPUT POWER
PRFE20W-072-D12-D
(25°C)

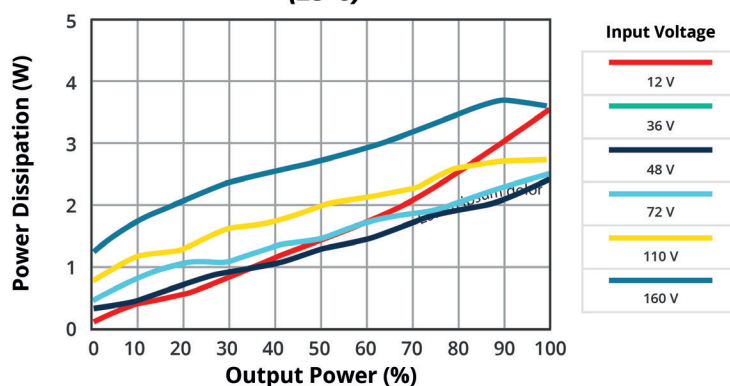

EFFICIENCY VS OUTPUT CURRENT
PRFE20W-072-D15-D
(25°C)

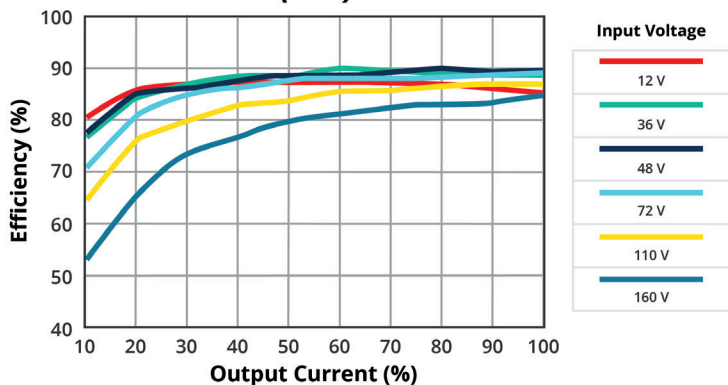

POWER DISSIPATION VS OUTPUT POWER
PRFE20W-072-D15-D
(25°C)

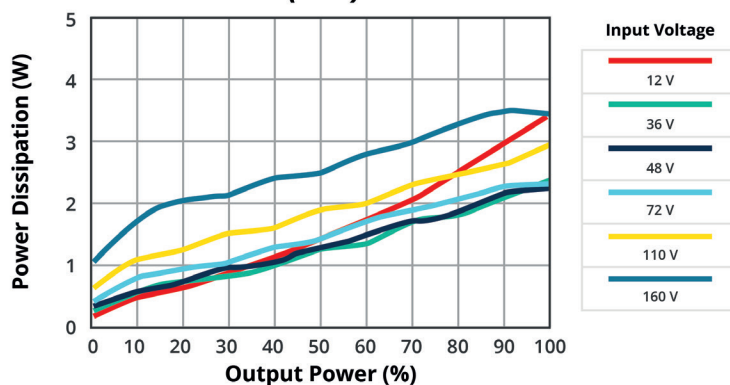

EFFICIENCY CURVES (CONTINUED)

EFFICIENCY VS OUTPUT CURRENT
PRFE20W-072-D24-D
(25°C)

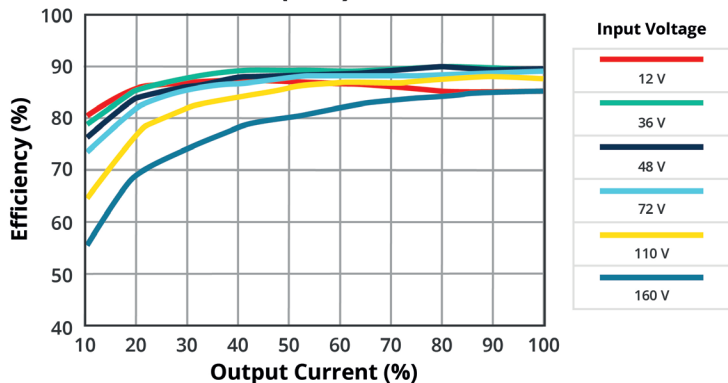

POWER DISSIPATION VS OUTPUT POWER
PRFE20W-072-D24-D
(25°C)

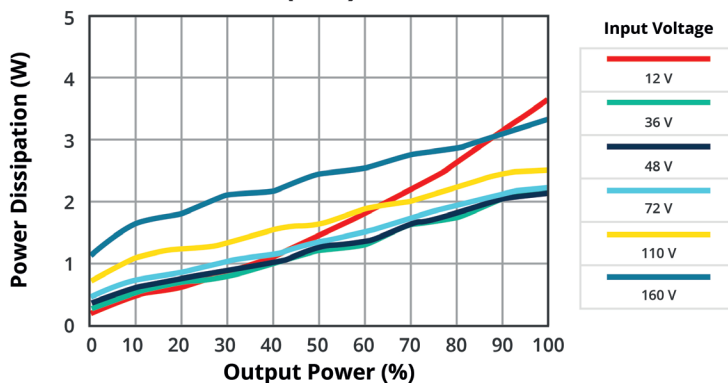

EFFICIENCY VS INPUT VOLTAGE
PRFE20W-072-S5-D
(25°C, full load)

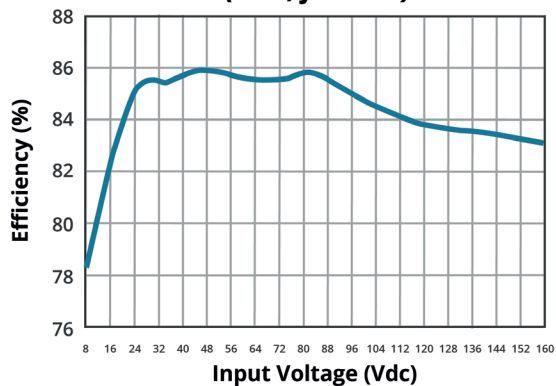

EFFICIENCY VS INPUT VOLTAGE
PRFE20W-072-S12-D
(25°C, full load)

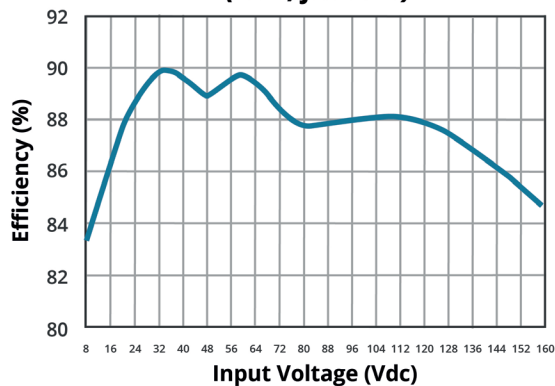

EFFICIENCY VS INPUT VOLTAGE
PRFE20W-072-S15-D
(25°C, full load)

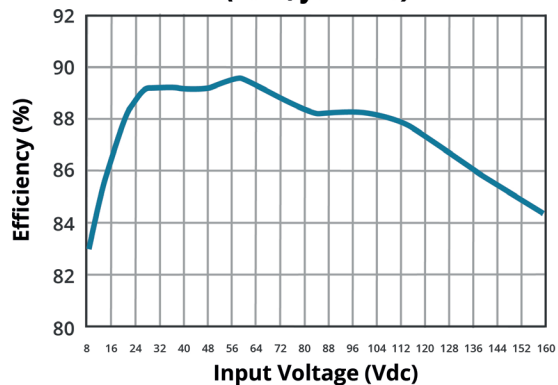

EFFICIENCY VS INPUT VOLTAGE
PRFE20W-072-D12-D
(25°C, full load)

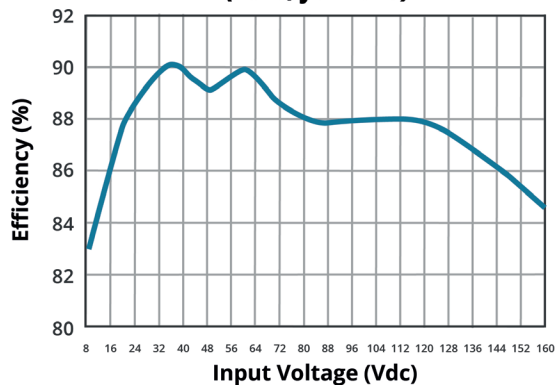

EFFICIENCY CURVES (CONTINUED)

EFFICIENCY VS INPUT VOLTAGE
PRFE20W-072-D15-D
(25°C, full load)

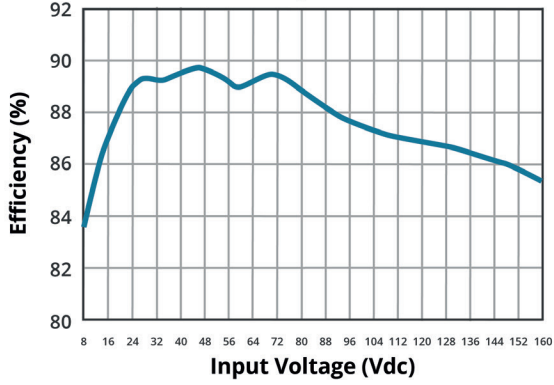

EFFICIENCY VS INPUT VOLTAGE
PRFE20W-072-D24-D
(25°C, full load)

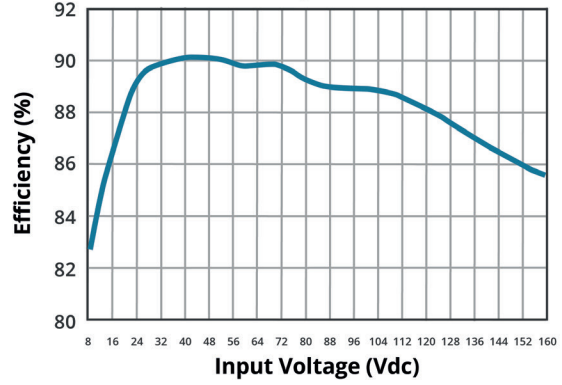

APPLICATION NOTES

Figure 1

Trim up

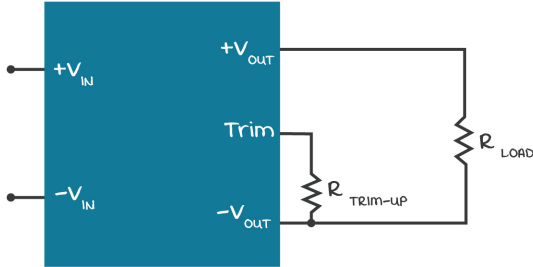

PRFE20W-072-S5-D

$$R_{\text{TRIM}} = \frac{22.13 - 3.976 \times (V_{\text{OUT}} - V_{\text{OUT,NOM}})}{7.017 \times (V_{\text{OUT}} - V_{\text{OUT,NOM}})} - 3.3 \text{ (k}\Omega\text{)}$$

Value of Trim up

PRFE20W-072-S12-D

$$R_{\text{TRIM}} = \frac{120.76}{3 \times (V_{\text{OUT}} - V_{\text{OUT,NOM}})} - 18 \text{ (k}\Omega\text{)}$$

Value of Trim up

PRFE20W-072-S15-D

$$R_{\text{TRIM}} = \frac{104.42}{2.28 \times (V_{\text{OUT}} - V_{\text{OUT,NOM}})} - 18 \text{ (k}\Omega\text{)}$$

Value of Trim up

Trim down

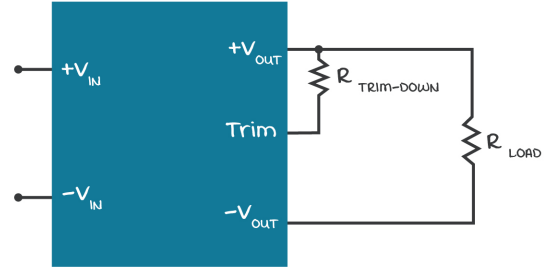

PRFE20W-072-S5-D

$$R_{\text{TRIM}} = \frac{42 - 16.803 \times (V_{\text{OUT,NOM}} - V_{\text{OUT}})}{7.017 \times (V_{\text{OUT,NOM}} - V_{\text{OUT}})} - 3.3 \text{ (k}\Omega\text{)}$$

Value of Trim down

PRFE20W-072-S12-D

$$R_{\text{TRIM}} = \frac{206.116}{3 \times (V_{\text{OUT,NOM}} - V_{\text{OUT}})} - 27.08 \text{ (k}\Omega\text{)}$$

Value of Trim down

PRFE20W-072-S15-D

$$R_{\text{TRIM}} = \frac{206.116}{2.28 \times (V_{\text{OUT,NOM}} - V_{\text{OUT}})} - 27.08 \text{ (k}\Omega\text{)}$$

Value of Trim down

Note: R_{TRIM} : External resistor in k Ω
 $V_{\text{OUT,NOM}}$: Nominal output voltage
 V_{OUT} : Desired output voltage

INPUT FUSING AND SAFETY CONSIDERATION

The PRFE20W-D series converters have no internal fuse. In order to achieve maximum safety and system protection, always use an input line fuse. We recommended a 3.15A time delay fuse for all models. It is recommended that the circuit have a transient voltage suppressor diode (TVS) across the input terminal to protect the unit against surge or spike voltage and input reverse voltage (as shown).

The external TVS & input capacitor (Cin) is required if PRFE20W-D series has to meet EN61000-4-4 & EN61000-4-5. The PRFE20W-D series recommended a TVS & aluminum capacitor (120µF/220V) to connect parallel.

Figure 2

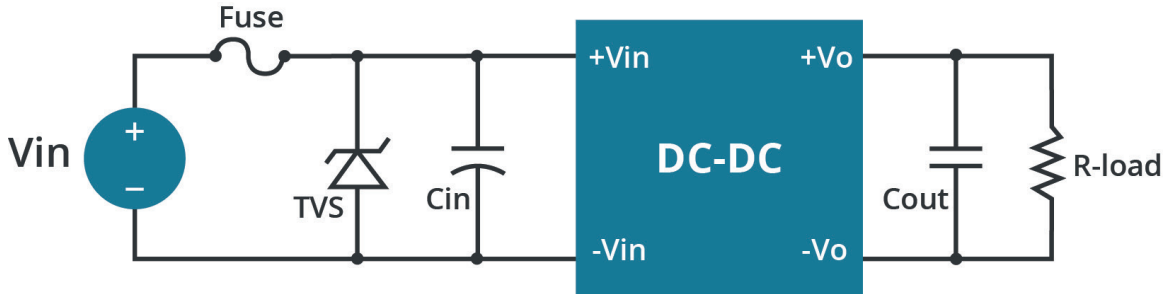

EMC CONSIDERATIONS

Figure 3

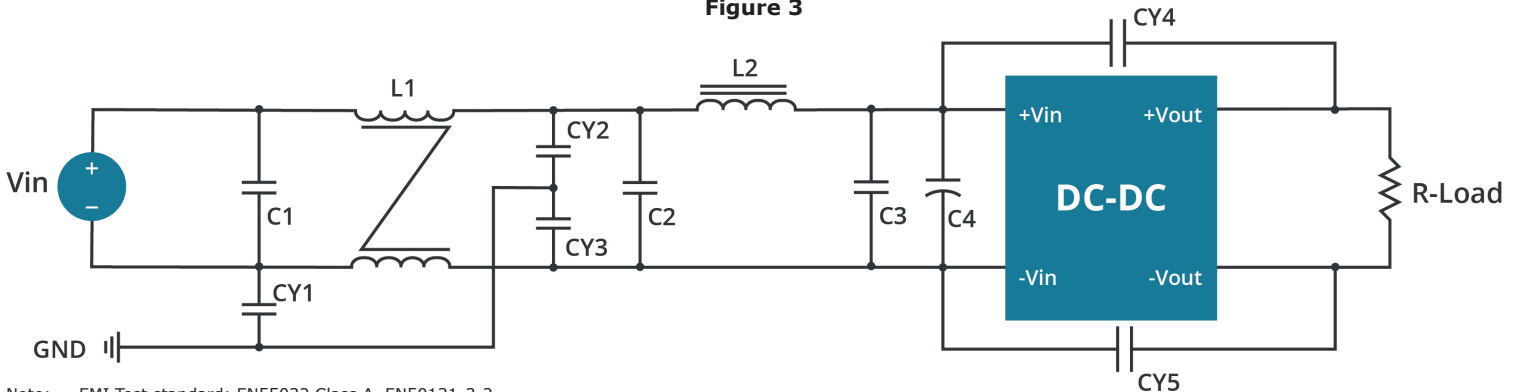

Note: EMI Test standard: EN55032 Class A, EN50121-3-2
 Test Condition: Input Voltage: 110Vdc, Output Load: Full Load
 (1) EMI meet EN55011 / EN55032 / EN50121-3-2

Table 1

MODEL NUMBER	C1 / C2 / C3	C4	CY1	CY2 / CY3	CY4 / CY5	L1	L2
PRFE20W-072-S5-D	1µF/250V 1812 Ceramic capacitor	120µF/220V KXJ Series Aluminum capacitor	680pF 400Vac Y1 capacitor	1500pF 400Vac Y1 capacitor	2200pF 400Vac Y1 capacitor	1.4mH Ø0.4mmx1/13T ACME A151 T10x5x5C	10µH/7A 2525CZ Vishay
PRFE20W-072-S12-D							
PRFE20W-072-S15-D							
PRFE20W-072-D12-D							
PRFE20W-072-D15-D							
PRFE20W-072-D24-D			470pF 400Vac Y1 Capacitor				

REVISION HISTORY

rev.	description	date
1.0	initial release	05/19/2022

The revision history provided is for informational purposes only and is believed to be accurate.



Headquarters
20050 SW 112th Ave.
Tualatin, OR 97062
800.275.4899

Fax 503.612.2383
cui.com
techsupport@cui.com

CUI offers a two (2) year limited warranty. Complete warranty information is listed on our website.

CUI reserves the right to make changes to the product at any time without notice. Information provided by CUI is believed to be accurate and reliable. However, no responsibility is assumed by CUI for its use, nor for any infringements of patents or other rights of third parties which may result from its use.

CUI products are not authorized or warranted for use as critical components in equipment that requires an extremely high level of reliability. A critical component is any component of a life support device or system whose failure to perform can be reasonably expected to cause the failure of the life support device or system, or to affect its safety or effectiveness.