

USER MANUAL

NI roboRIO

RIO Device for Robotics

The NI roboRIO is a portable reconfigurable I/O (RIO) device that students can use to design control, robotics, and mechatronics systems used in the FIRST Robotics Competition (FRC). This document contains pinouts, connectivity information, dimensions, and mounting instructions for the NI roboRIO. The NI roboRIO provides the I/O shown in Figure 1 and connects to a host computer over USB and 10/100 Ethernet.

Figure 1. NI roboRIO Features

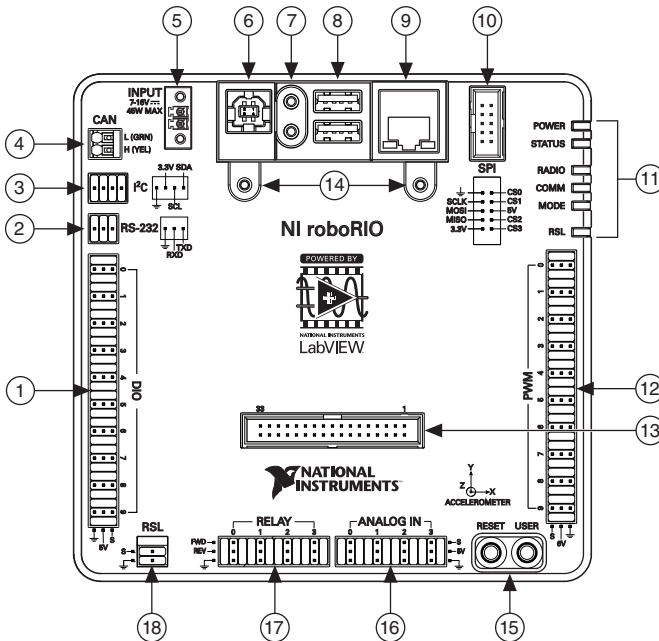

- | | | | |
|---|-------------------------------------|----|--|
| 1 | Digital input and output (DIO) port | 10 | Serial peripheral interface bus (SPI) port |
| 2 | RS-232 port | 11 | LEDs |
| 3 | I ² C port | 12 | Pulse-width modulation (PWM) port |
| 4 | CAN port | 13 | myRIO Expansion Port (MXP) |
| 5 | Power connector | 14 | MXP retention mount |
| 6 | USB Device port | 15 | User and Reset buttons |
| 7 | USB Host retention mount | 16 | Analog input (AI) port |
| 8 | USB Host ports | 17 | Relay port |
| 9 | Ethernet port | 18 | Robot signal light (RSL) port |

Contents

Safety Information	3
Electromagnetic Compatibility Guidelines	3
Hardware Block Diagram	4
Setting Up the NI roboRIO	5
Wiring Power to the NI roboRIO	5
Powering On the NI roboRIO	5
Connecting the NI roboRIO to a Network	6
Preparing the NI roboRIO for Competition	6
User Power	6
Pinouts	8
MXP	8
CAN Port	9
I ² C Port	10
RS-232 Port	10
DIO Port	11
RSL Port	11
Relay Port	12
AI Port	12
PWM Port	13
SPI Port	13
Signal Ground References	14
Interfaces	14
AI Channels	14
AO Channels	14
DIO, PWM, and Relay Lines	15
UART and RS-232 Lines	16
SPI Lines	16
I ² C Lines	16
USB Device Port	16
USB Host Port	16
Accelerometer	17
Converting Raw Data Values to Voltage	17
Front Panel Buttons	17
Reset Button	17
User Button	18
LED Indications	18
Power LED	18
Status LED	19
Radio LED	19
Comm LED	20
Mode LED	20
RSL (Safety) LED	21
Physical Dimensions	22

Mounting the NI roboRIO	25
Method One: Using Cable Ties to Secure One Edge of the NI roboRIO to Perfboard.....	25
Method Two: Using Cable Ties to Secure One Corner of the NI roboRIO to Perfboard.....	27
Method Three: Using Screws to Secure the Bottom of the NI roboRIO to a Metal Plate	30
Compatible USB and Ethernet Cables.....	30
Warranty	31
Worldwide Support and Services	31

Safety Information



Caution Do not operate the hardware in a manner not specified in the user documentation. Misuse of the hardware can result in a hazard. You can compromise the safety protection if the hardware is damaged in any way. If the hardware is damaged, contact National Instruments for repair.

Clean the hardware with a soft, nonmetallic brush. Make sure that the hardware is completely dry and free from contaminants before returning it to service.

Electromagnetic Compatibility Guidelines

This product was tested and complies with the regulatory requirements and limits for electromagnetic compatibility (EMC) stated in the product specifications. These requirements and limits provide reasonable protection against harmful interference when the product is operated in the intended operational electromagnetic environment.

This product is intended for use in industrial locations. However, harmful interference may occur in some installations, when the product is connected to a peripheral device or test object, or if the product is used in residential or commercial areas. To minimize interference with radio and television reception and prevent unacceptable performance degradation, install and use this product in strict accordance with the instructions in the product documentation.

Furthermore, any modifications to the product not expressly approved by National Instruments could void your authority to operate it under your local regulatory rules.



Caution To ensure the specified EMC performance, the maximum length for DIO, RS-232, I²C, CAN, SPI, PWM, AI, Relay, and RSL signal wires is 2.0 m (6.56 ft). The maximum length for USB cables is 5.0 m (16.40 ft). The maximum length for Ethernet cables is 30.0 m (98.43 ft). Refer to the [Compatible USB and Ethernet Cables](#) section of this document for information about compatible USB and Ethernet cables.

Hardware Block Diagram

Figure 2 shows the arrangement and functions of NI roboRIO components.

Figure 2. NI roboRIO Hardware Block Diagram

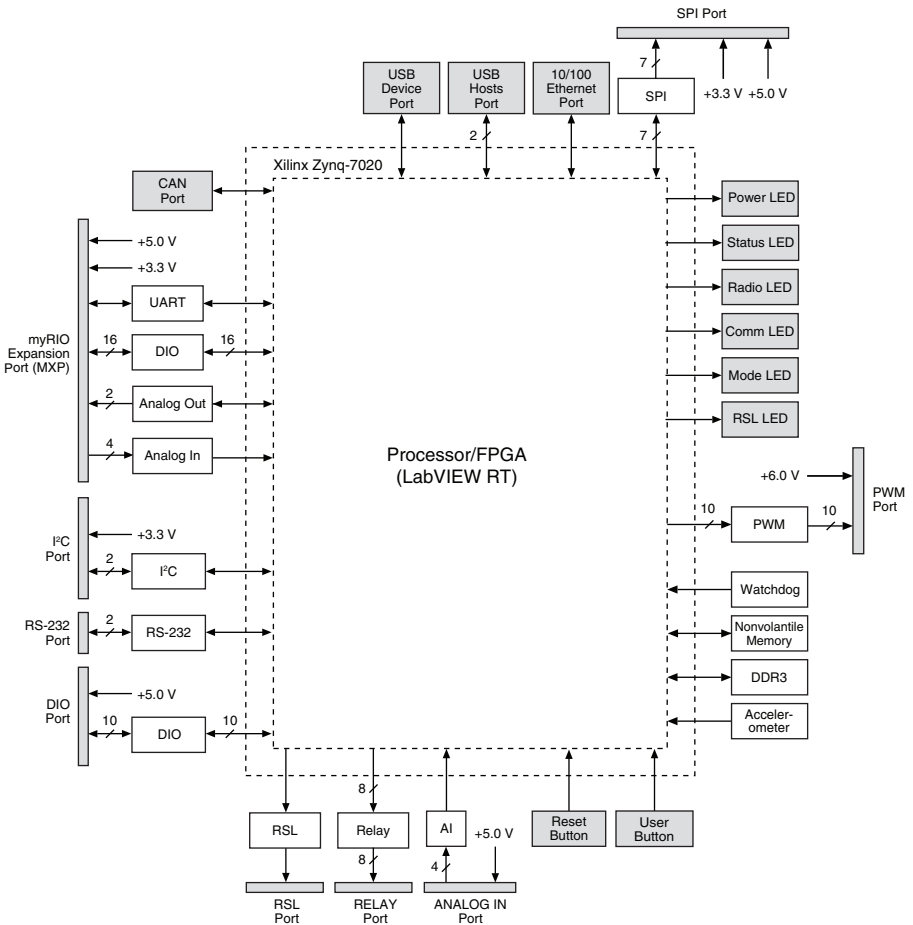

Setting Up the NI roboRIO

Wiring Power to the NI roboRIO

The NI roboRIO requires an external power supply that meets the specifications in the *Power Requirements* section of the *NI roboRIO Specifications*. The NI roboRIO filters and regulates the supplied power and provides power for all of the I/O and user voltage. The NI roboRIO has one layer of reverse-voltage protection. Complete the following steps to connect a power supply to the chassis.

1. Ensure that the power supply is turned off.



Caution Do *not* install or remove the power connector from the front panel of the NI roboRIO while power is applied.

2. Connect the positive lead of the power supply to the V terminal of the COMBICON power connector shipped with the NI roboRIO, and tighten the terminal screw. Figure 3 shows the terminal screws, which secure the wires in the screw terminals, and the connector screws, which secure the power connector on the front panel.

Figure 3. NI roboRIO COMBICON Power Connector

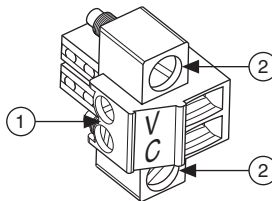

1 Terminal Screws

2 Connector Screws

3. Connect the negative lead of the power supply to the C terminal of the power connector and tighten the terminal screw.
4. Install the power connector on the front panel of the NI roboRIO and tighten the connector screws.
5. Turn on the power supply.

Powering On the NI roboRIO

When you apply power, the NI roboRIO runs a power-on self test (POST). During the POST, the Power and Status LEDs turn on. The Status LED turns off, indicating that the POST is complete. If the LEDs do not behave in this way when the system powers on, refer to the [LED Indications](#) section.

Connecting the NI roboRIO to a Network

Connect the NI roboRIO to an Ethernet network using the Ethernet port. Use a standard Category 5 (CAT-5) or better shielded, twisted-pair Ethernet cable to connect the NI roboRIO to an Ethernet hub, router, or directly to a computer.



Caution To prevent data loss and to maintain the integrity of your Ethernet installation, do *not* use a cable longer than 30 m.

The first time you power up the chassis, it attempts to initiate a DHCP network connection. If the chassis is unable to initiate a DHCP connection, it connects to the network with a link-local IP address with the form `169.254.x.x`.

Preparing the NI roboRIO for Competition

For information about configuring the controller for competitive use, refer to the Tutorials tab in the Getting Started window of LabVIEW for FRC.

User Power

Table 1 describes the user voltage rails for powering external sensors and peripherals. The rails are independent from the power supplies of internal systems, such as the processor and memory.

Table 1. NI roboRIO Voltage Rails

Voltage Rail	Description
+6 V	Power from PWM ports for use with servos.
+5 V	Power for DIO and AI ports for sensors, and power for the MXP for powering expansion circuits.
+3.3 V	Power for I ² C, SPI, and the MXP.

Input Voltage Brownout Behavior

The NI roboRIO input voltage range is 7 V to 16 V. The input voltage monitoring circuit monitors the voltage on the input voltage pin. When the input voltage drops to between 4.5 V and 6.8 V, the NI roboRIO enters brownout mode with a staged response, as Table 2 describes.

Table 2. NI roboRIO Input Voltage Brownout Behavior

Stage	Input Voltage Range	Behavior
1	6.3 V to 6.8 V	The +6 V voltage rail starts to drop.
2	4.5 V to 6.3 V	<p>The NI roboRIO enters a brownout fault condition and the following precautions are taken:</p> <ul style="list-style-type: none">• User voltage rails become disabled.• All PWM generation stops at the conclusion of the current cycle.• GPIOs configured as outputs go to High-Z.• Relay control outputs are driven low.• CAN-based motor controllers become disabled. <p>The following systems continue to function normally with valid data and communication:</p> <ul style="list-style-type: none">• FPGA, processor, RAM, disk, and user code• USB power and communication• Radio, if powered by USB• Ethernet• CAN• AI and AO• I²C• SPI• RS-232 serial• LED and RSL status lights <p>Stage 2 continues until the input voltage rises to greater than 7.5 V or drops to less than 4.5 V.</p>
3	Less than 4.5 V	<p>All controller functions cease and the controller state is lost. This condition continues until the input voltage rises to greater than 4.65 V, at which point the controller starts the normal booting sequence. At startup, the controller remains in Stage 2 until the input voltage rises to greater than 7.5 V.</p>

Pinouts

The following describe the pins and signals on the NI roboRIO ports.

MXP

Figure 4 and Table 3 describe the MXP pins and signals. Note that some pins carry both primary and secondary functions.

Figure 4. MXP Pinout

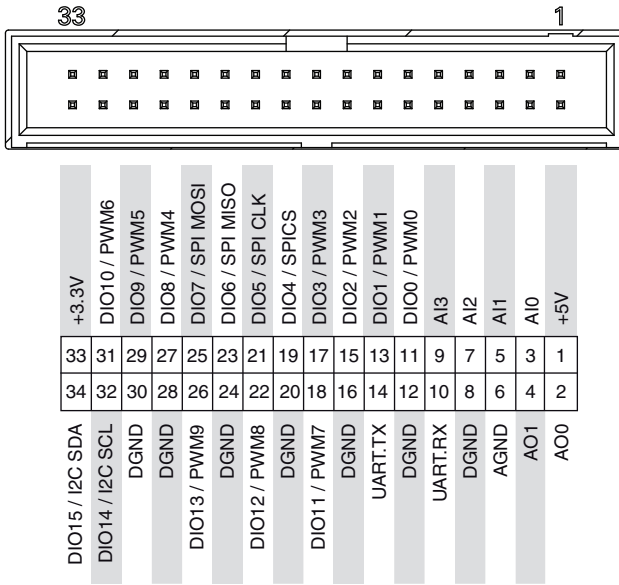

Table 3. MXP Signal Descriptions

Signal Name	Reference	Direction	Description
+5V	DGND	Output	+5 V power output.
AI <0..3>	AGND	Input	0 to 5 V, referenced, single-ended AI channels. Refer to the <i>AI Channels</i> section for more information.
AO <0..1>	AGND	Output	0 to 5 V referenced, single-ended AO. Refer to the <i>AO Channels</i> section for more information.
AGND	—	—	Reference for AI and AO.
+3.3V	DGND	Output	+3.3 V power output.

Table 3. MXP Signal Descriptions (Continued)

Signal Name	Reference	Direction	Description
DIO <0..15>	DGND	Input or Output	General-purpose digital lines with 3.3 V output, 3.3 V/5 V-compatible input. Refer to the <i>DIO, PWM, and Relay Lines</i> section for more information.
UART.RX	DGND	Input	UART receive input. UART lines are electrically identical to DIO lines.
UART.TX	DGND	Output	UART transmit output. UART lines are electrically identical to DIO lines.
DGND	—	—	Reference for digital signals, +5 V, and +3.3 V.

CAN Port

Figure 5 and Table 4 describe the CAN port pins and signals.

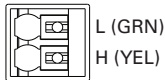
Figure 5. CAN Port Pinout**Table 4.** CAN Port Signal Descriptions

Signal Name	Direction	Description
L (GRN)	Input/Output	CAN bus differential low signal.
H (YEL)	Input/Output	CAN bus differential high signal.



Note The NI roboRIO contains an internal 120 Ω termination resistor between L (GRN) and H (YEL).

I²C Port

Figure 6 and Table 5 describe the I²C port pins and signals.

Figure 6. I²C Port Pinout

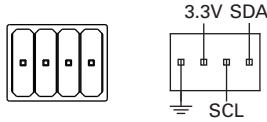

Table 5. I²C Port Signal Descriptions

Signal Name	Direction	Description
GND	—	Reference for digital lines and +3.3 V power output.
3.3V	Output	+3.3 V power output.
SCL	Input or Output	I ² C lines with 3.3 V output, 3.3 V/5 V-compatible input. Refer to the P²C Lines section for more information.
SDA	Input or Output	

RS-232 Port

Figure 7 and Table 6 describe the RS-232 port pins and signals.

Figure 7. RS-232 Serial Port Pinout

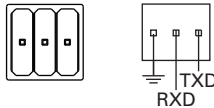

Table 6. RS-232 Serial Port Signal Descriptions

Signal Name	Direction	Description
TXD	Output	Serial transmit output with ± 5 V to ± 15 V signal levels. Refer to the UART and RS-232 Lines section for more information.
RXD	Input	Serial receive input with ± 15 V input voltage range. Refer to the UART and RS-232 Lines section for more information.
GND	—	Reference for digital lines.

DIO Port

Figure 8 and Table 7 describe the DIO port pins and signals.

Figure 8. DIO Port Pinout

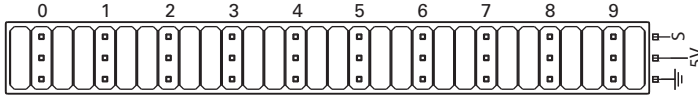

Table 7. DIO Port Signal Descriptions

Signal Name	Direction	Description
S (DIO) <0..9>	Input/Output	General-purpose digital lines with 3.3 V output, 3.3 V/5 V-compatible input. Refer to the <i>DIO, PWM, and Relay Lines</i> section for more information.
5V	Output	+5 V power output.
GND	—	Reference for digital lines and +5 V power output.

RSL Port

Figure 9 and Table 8 describe the RSL port pins and signals.

Figure 9. RSL Port Pinout

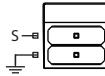

Table 8. RSL Port Signal Descriptions

Signal Name	Direction	Description
S	Output	Switched power output to drive RSL when RSL is enabled. The voltage level depends on the connected input voltage. RSL current is limited at 120 mA.
GND	—	Reference for S.

Relay Port

Figure 10 and Table 9 describe the Relay port pins and signals.

Figure 10. Relay Port Pinout

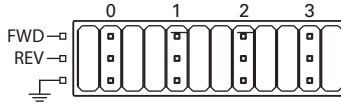

Table 9. Relay Port Signal Descriptions

Signal Name	Direction	Description
FWD <0..3>	Output	Relay digital lines with 5 V output.
REV <0..3>	Output	Relay digital lines with 5 V output.
GND	—	Reference for digital lines.

AI Port

Figure 11 and Table 10 describe the AI port pins and signals.

Figure 11. AI Port Pinout

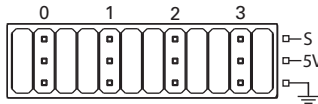

Table 10. AI Port Signal Descriptions

Signal Name	Direction	Description
S (AI) <0..3>	Input	0 V to 5 V referenced, single-ended AI channels. Refer to the <i>AI Channels</i> section for more information.
5V	Output	+5 V power output.
GND	—	Reference for AI and +5 V power.

PWM Port

Figure 12 and Table 11 describe the PWM port pins and signals.

Figure 12. PWM Port Pinout

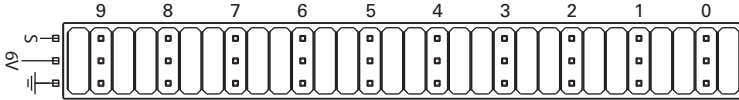

Table 11. PWM Port Signal Descriptions

Signal Name	Direction	Description
S (PWM) <0..9>	Output	PWM digital lines with 5 V output.
6V	Output	+6 V power output for servos only.
GND	—	Reference for digital lines and +6 V power output.

SPI Port

Figure 13 and Table 12 describe the SPI port pins and signals.

Figure 13. SPI Port Pinout

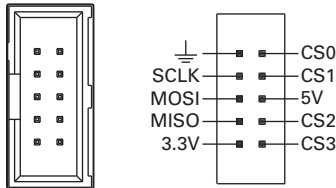

Table 12. SPI Port Signal Descriptions

Signal Name	Direction	Description
3.3V	Output	+3.3 V power output.
5V	Output	+5 V power output.
CS <0..3>	Output	SPI with 3.3 V output, 3.3 V/5 V-compatible input. Refer to the <i>SPI Lines</i> section for more information.
SCLK	Output	
MOSI	Output	
MISO	Input	
GND	—	Reference for digital lines and +3.3 V and +5.5 V power output.

Signal Ground References

To minimize noise on analog measurement channels, use the ground reference of the corresponding port. For example, when you are using AI, the measurement should reference the GND of the AI port.

Interfaces

AI Channels

The NI roboRIO has AI channels on the MXP and on the AI port. The channels are multiplexed to a single analog-to-digital converter (ADC) that samples all channels.

The MXP and the AI port each has four single-ended AI channels, AI0-AI3, which you can use to measure 0-5 V signals.



Note For important information about improving measurement accuracy by reducing noise, visit ni.com/info and enter the Info Code `analogwiring`.

Figure 14 shows the AI topology of the NI roboRIO.

Figure 14. NI roboRIO AI Circuitry

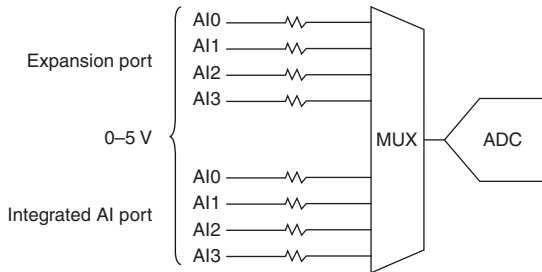

AO Channels

The NI roboRIO MXP has two AO channels, AO0 and AO1, which you can use to generate signals of 0 V to 5 V. Each channel has a dedicated digital-to-analog converter (DAC), which allows all AO channels to update simultaneously. The maximum update rate is specified as an aggregate rate in the *Analog Output* section of the *NI roboRIO Specifications*.

Figure 15 shows the AO topology of the NI roboRIO.

Figure 15. NI roboRIO AO Circuitry

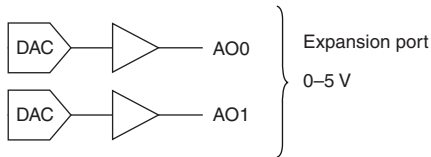

DIO, PWM, and Relay Lines

The NI roboRIO provides the following DIO lines:

- 3.3 V general-purpose DIO lines on the MXP
- 3.3 V digital lines on the DIO, I²C, and SPI ports
- 5 V digital lines on the PWM and Relay ports.

DIO <9..0> on the DIO port, CS <3..0> on the SPI port, and DIO <13..0> on the MXP all have 40 k Ω pullup resistors to 3.3 V, as shown in Figure 16.

Figure 16. DIO Lines with 40 k Ω Pullup Resistors to 3.3 V

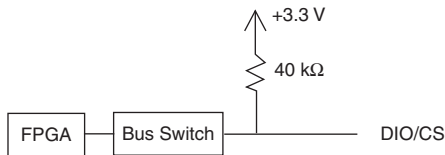

DIO <15..14> on the MXP and the two lines on the I²C port all have 2.2 k Ω pullup resistors to 3.3 V, as shown in Figure 17.

Figure 17. DIO Lines with 2.2 k Ω Pullup Resistors to 3.3 V

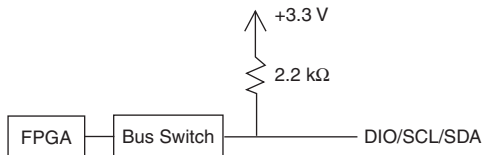

<SCLK, MOSI, MISO> on the SPI port and the lines on the PWM and Relay ports all have 40 k Ω pulldown resistors to ground, as shown in Figure 18.

Figure 18. DIO Lines with 40 k Ω Pulldown Resistors to Ground

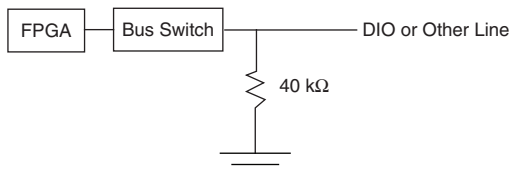

You can program all MXP DIO lines and on-board DIO lines individually as inputs or outputs. Secondary digital functions include SPI, I²C, PWM, and quadrature encoder input. Refer to the NI roboRIO software documentation for information about configuring the behavior of the DIO lines.

When a DIO line is floating, it floats in the direction of the pull resistor. A DIO line may be floating in any of the following conditions:

- When the NI roboRIO device is starting up
- When the line is configured as an input
- When the NI roboRIO device is powering down

You can add a stronger resistor to a DIO line to cause it to float in the opposite direction.

UART and RS-232 Lines

The NI roboRIO has one UART connected to the UART lines on the MXP and one UART connected to the RS-232 port.

The UART lines on the MXP are electrically identical to DIO lines 0 to 13 on the MXP. Like those lines, UART.RX and UART.TX have 40 k Ω pullup resistors to 3.3 V.

The RS-232 lines are compliant with TIA/EIA-232-F voltage levels.

SPI Lines

The SPI port can support up to four devices by using each of the four Chip Select (CS) lines.

I²C Lines

The I²C lines can be used to connect to a network of I²C slave devices..

USB Device Port

You can deploy and debug code by connecting a USB cable from the USB device port on the NI roboRIO to a computer.

USB Host Port

The NI roboRIO USB host port supports the following devices:

- Web cameras that conform to the USB Video Device Class (UVC) protocol.
- Machine vision cameras that conform to the USB3 Vision standard and are backward compatible with the USB 2.0 specification.
- Basler ace USB3 cameras.
- USB Flash drives.
- USB-to-IDE adapters formatted with FAT16 and FAT32 file systems.

LabVIEW usually maps USB devices to the /U, /V, /W, or /X drive, starting with the /U drive if it is available.

Accelerometer

The NI roboRIO contains a three-axis accelerometer, MMA8452Q. Refer to the *Accelerometer* section of the *NI roboRIO Specifications* for the accelerometer sample rates.

Converting Raw Data Values to Voltage

You can use the following equations to convert raw data values to volts:

$$V = \text{Raw Data Value} * \text{LSB Weight}$$

$$\text{LSB Weight} = \text{Nominal Range} \div 2^{\text{ADC Resolution}}$$

where *Raw Data Value* is the value returned by reading in the input channel, *LSB Weight* is the value in volts of the increment between data values, *Nominal Range* is the absolute value in volts of the full, peak-to-peak nominal range of the channel, and *ADC Resolution* is the resolution of the ADC in bits. (*ADC Resolution* = 12.)

- For AI and AO channels on the MXP,

$$\text{LSB Weight} = 5 \text{ V} \div 2^{12} = 1.221 \text{ mV}$$

$$\text{Maximum reading} = 4095 * 1.221 \text{ mV} = 4.999 \text{ V}$$

- For the accelerometer,

$$\text{LSB Weight} = 16 \text{ g} \div 2^{12} = 3.906 \text{ mg}$$

$$\text{Maximum Positive Reading} = +2047 * 3.906 \text{ mg} = +7.996 \text{ g}$$

$$\text{Maximum Negative Reading} = -2048 * 3.906 \text{ mg} = -8.000 \text{ g}$$

Front Panel Buttons

Reset Button

Pressing and releasing the Reset button restarts the processor and the FPGA.

Pressing and holding the Reset button until the status LED lights (about five seconds) and then releasing the Reset button restarts the processor and the FPGA and forces the NI roboRIO into safe mode. In safe mode, the NI roboRIO launches only the services necessary for updating configuration and installing software.

When the NI roboRIO is in safe mode, you can communicate with it by using the serial lines on the RS-232 serial port. You must configure your serial-port terminal program with the following settings:

- 115,200 bits per second
- Eight data bits

- No parity
- One stop bit
- No flow control

User Button

The User Button produces a logic TRUE when depressed and a logic FALSE when not depressed. The User Button is not debounced in hardware.

LED Indications

Power LED

The Power LED is a tri-color red/green/yellow LED that indicates specific conditions, as shown in Table 13.

Table 13. Power LED Indications

Color	State	Indication
Off	Off	Power is outside valid input range.
Green	Solid	Power is valid with no fault condition.
Red	Solid	Fault condition detected. One or more user voltage rails are in short-circuit or overcurrent condition.
Red	Flashing	The input voltage is too high (greater than 16 V) and all outputs, including the RSL output, are disabled.
Yellow	Solid	Brownout condition detected. The 6 V user rail and outputs are disabled.

Status LED

The Status LED is a single-color yellow LED. The Status LED is off during normal operation. The NI roboRIO runs a power-on self test (POST) when you apply power to the device. During the POST, the Power and Status LEDs turn on. When the Status LED turns off, the POST is complete. The NI roboRIO indicates specific error conditions by flashing the Status LED a certain number of times every few seconds, as shown in Table 14.

Table 14. Status LED Indications

Number of Flashes Every Few Seconds	Indication
2	The device has detected an error in its software. This usually occurs when an attempt to upgrade the software is interrupted. Reinstall software on the device.
3	The device is in safe mode.
4	The software has crashed twice without rebooting or cycling power between crashes. This usually occurs when the device runs out of memory. Review your RT VI and check the memory usage. Modify the VI as necessary to solve the memory usage issue.
Continuously flashing or solid	The device has detected an unrecoverable error. Contact National Instruments.

Radio LED

The Radio LED is a tri-color red/green/yellow LED that indicates specific conditions for an USB-connected radio, as shown in Table 15.

Table 15. Radio LED Indications

Color	State	Indication
Off	Off	No connection detected.
Yellow	Blinking	Booting as access point. Radio is enabled and access point is being constructed.
Yellow	Solid	Access point active. Radio is enabled and in access point mode.
Green	Blinking	Booting as bridge. Radio is enabled and bridging is in progress.
Green	Solid	Bridge active. Radio is enabled and has bridge configured with SSID settings.
Red	Any	Reserved.

Other LED states may indicate other, undetermined radio issues or failures. This LED is undefined if a USB radio is not used.

Comm LED

The Comm LED is a tri-color red/green/yellow LED that indicates robot communication conditions, as shown in Table 16.

Table 16. Comm LED Indications

Color	State	Indication
Off	Off	No communication detected. No heartbeat detected.
Red	Solid	No code. The protocol indicates that no user code has been loaded.
Red	Blinking	E-Stop. The protocol indicates that the driver station has E-Stopped the robot.
Green	Solid	Active. The protocol is active and the driver station is in control of the robot.
Yellow	Any	Reserved.

Mode LED

The Mode LED is a tri-color red/green/yellow LED that indicates the mode of the NI roboRIO outputs, as shown in Table 17.

Table 17. Mode LED Indications

Color	State	Indication
Off	Off	Outputs disabled.
Green	Solid	Outputs enabled. Autonomous mode.
Yellow	Solid	Outputs enabled. TeleOperated mode.
Red	Solid	Outputs unknown, undetermined, or in test mode.

RSL (Safety) LED

The RSL LED is a single-color yellow LED that functions identically to the RSL, which is an external indicator connected to the NI roboRIO using a dedicated connector, and indicates specific conditions, as shown in Table 18.

Table 18. RSL LED Indications

Color	State	Indication
Off	Off	Outputs disabled. No power.
Yellow	Solid	Outputs disabled. Robot is powered.
Yellow	Blinking	Outputs enabled. Robot is powered.

Physical Dimensions

Figures 19 through 22 describe the physical dimensions of the NI roboRIO enclosure and its features.

Figure 19. NI roboRIO Dimensions, Primary Side

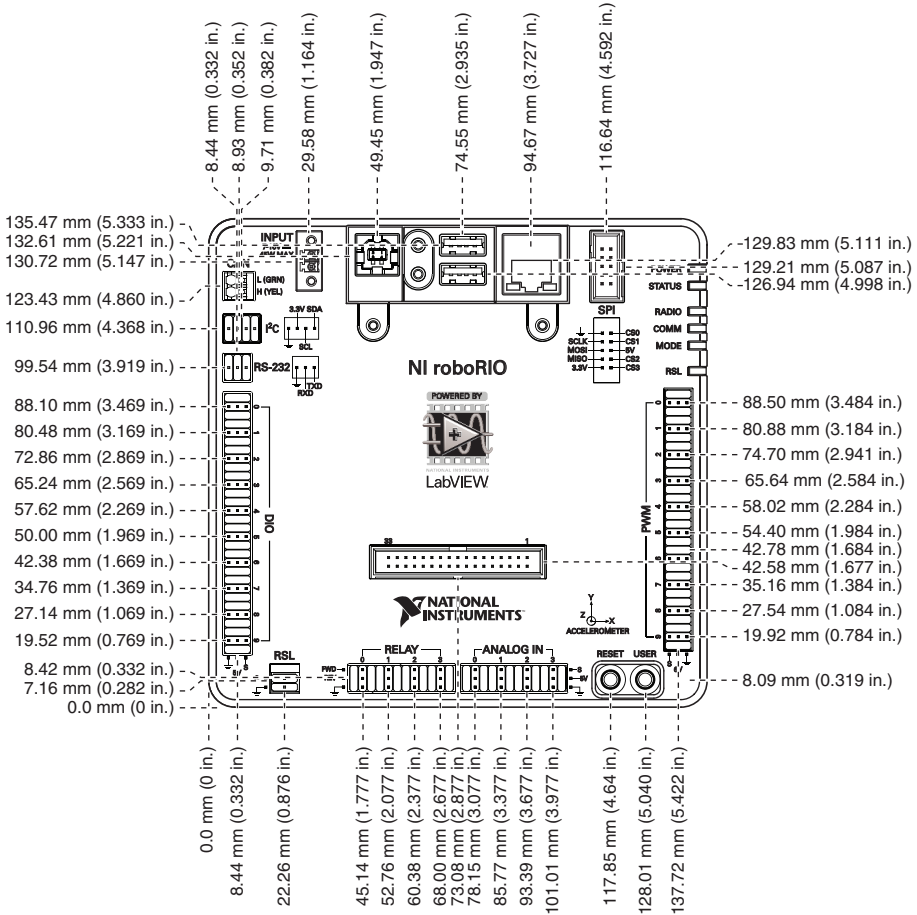

Figure 20. NI roboRIO Dimensions, Primary Side LEDs

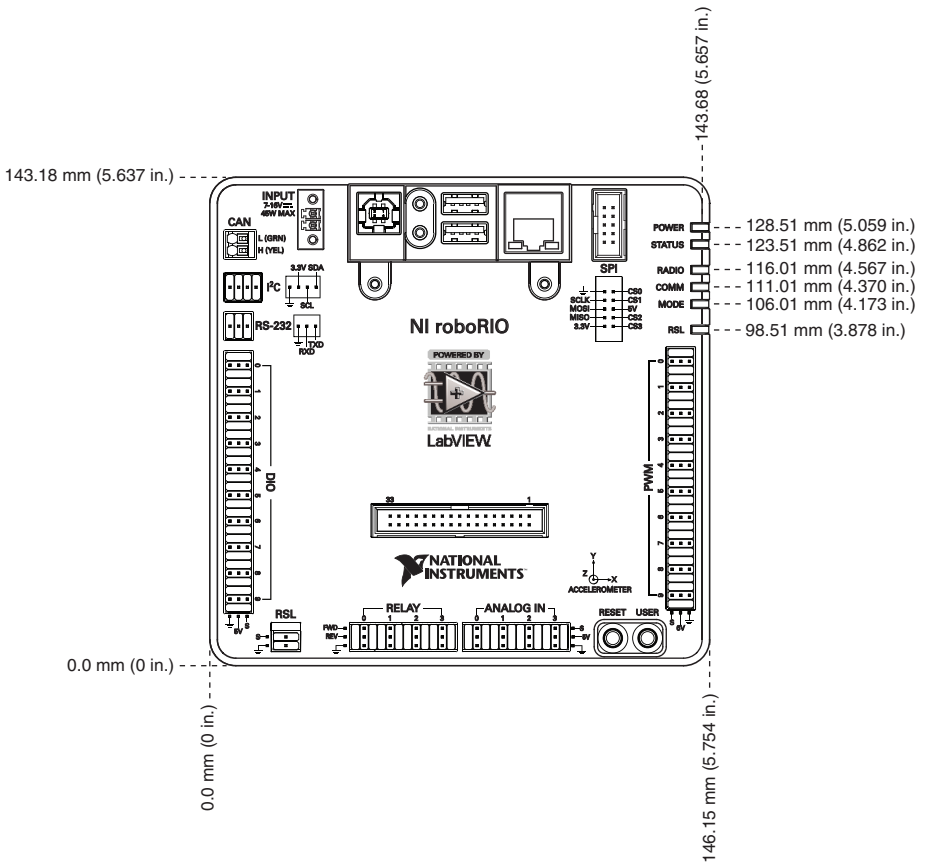

Figure 21. NI roboRIO Dimensions, Secondary Side

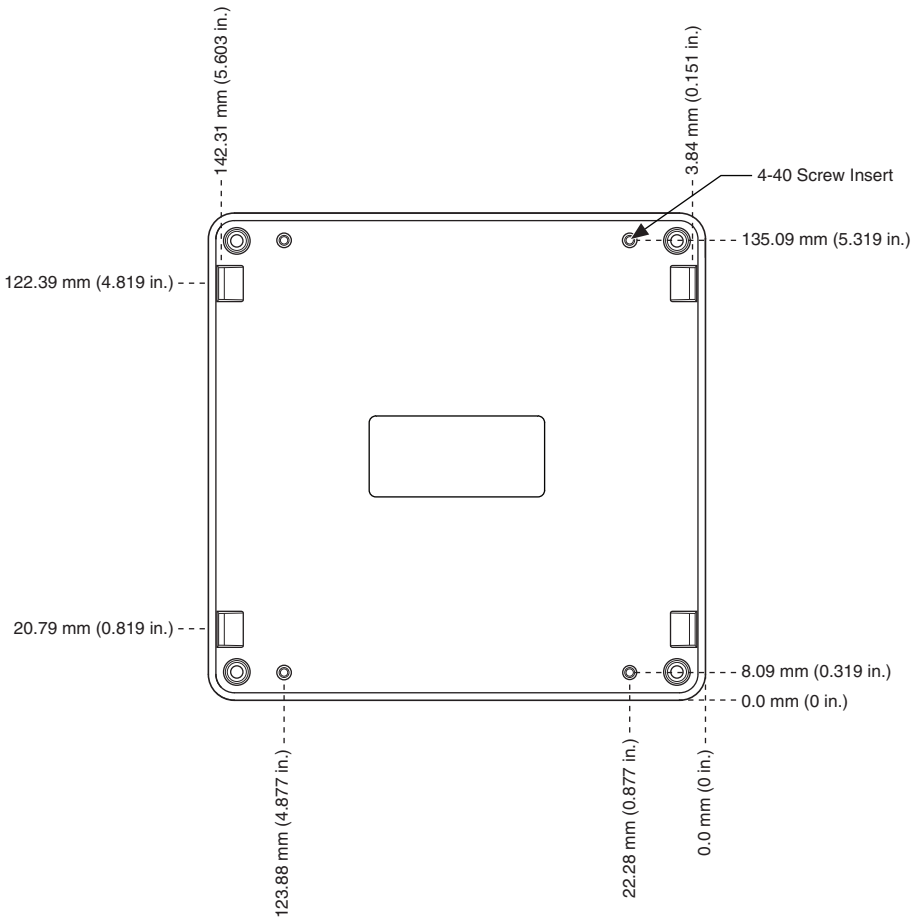
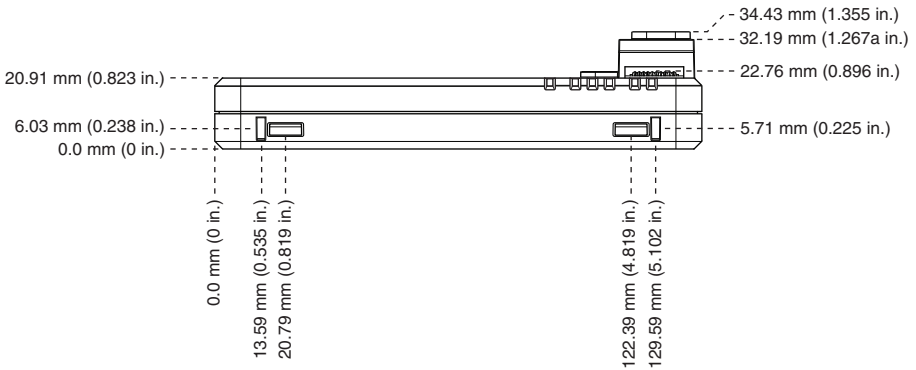

Figure 22. NI roboRIO Dimensions, Side



Mounting the NI roboRIO

You can mount the NI roboRIO in the following ways:

- Using cable ties to secure one edge of the NI roboRIO to perfboard with 6.35 mm (0.25 in.) diameter holes on 12.7 mm (0.5 in.) straight centers, such as AndyMark part number am-0836.
- Using cable ties to secure one corner of the NI roboRIO to perfboard.
- Using screws to secure the bottom of the NI roboRIO to a metal plate.

Method One: Using Cable Ties to Secure One Edge of the NI roboRIO to Perfboard

Figures 23 through 26 show how to secure one edge of the NI roboRIO to perfboard.

Figure 23. Cable Ties, Method One, Step One

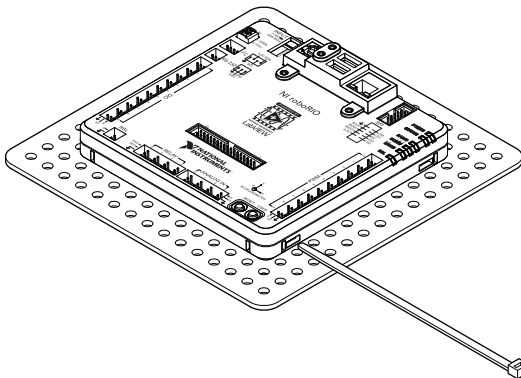

Figure 24. Cable Ties, Method One, Step Two

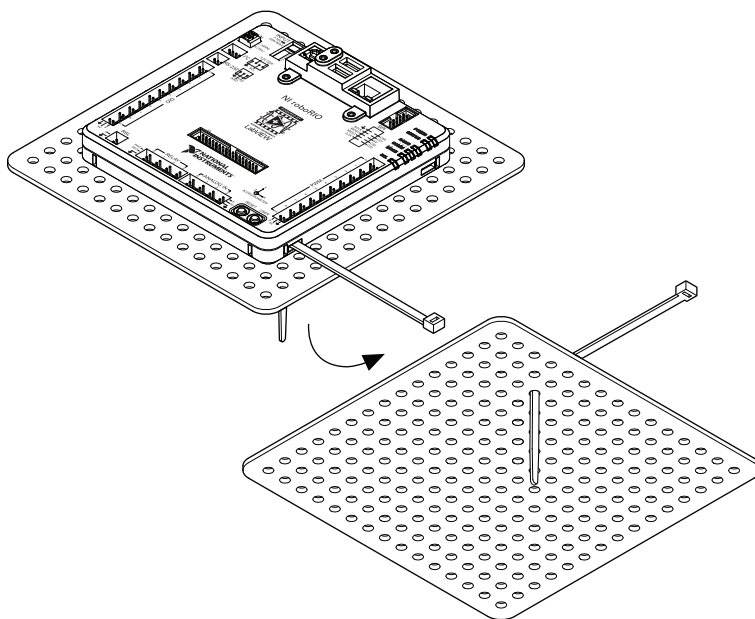

Figure 25. Cable Ties, Method One, Step Three

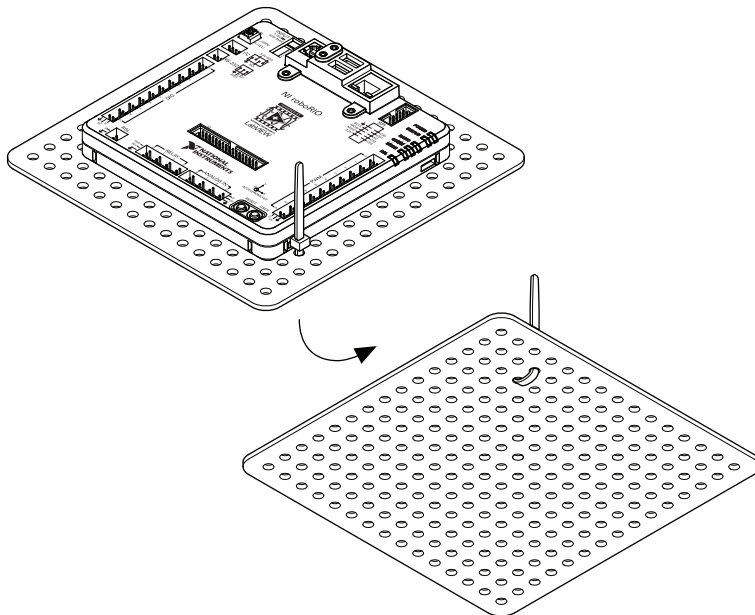
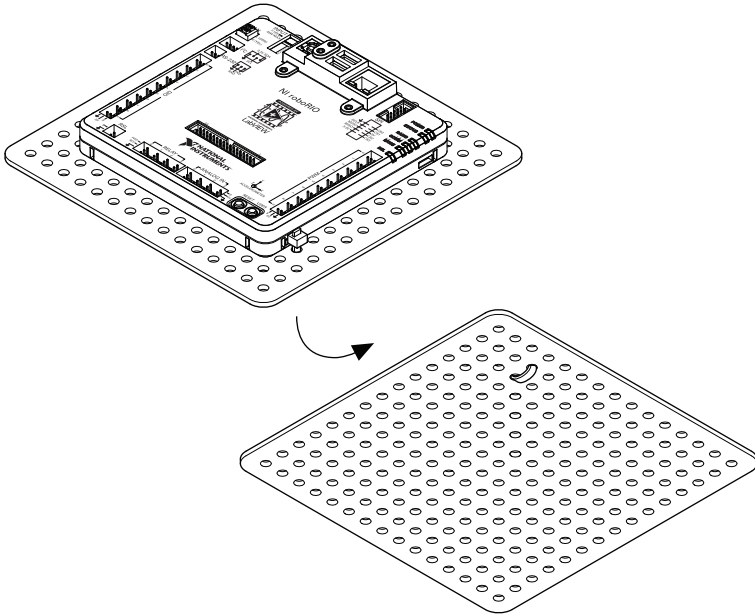

Figure 26. Cable Ties, Method One, Step Four



Method Two: Using Cable Ties to Secure One Corner of the NI roboRIO to Perfboard

Figures 27 through 31 show how to secure one corner of the NI roboRIO to perfboard.

Figure 27. Cable Ties, Method Two, Step One

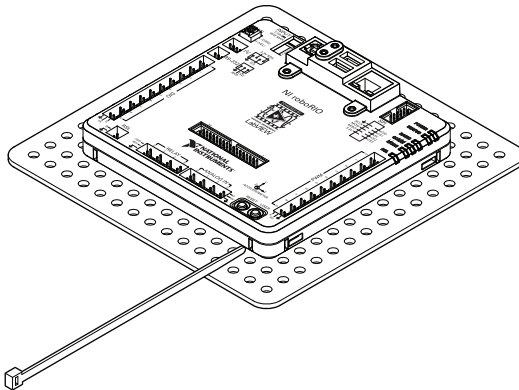

Figure 28. Cable Ties, Method Two, Step Two

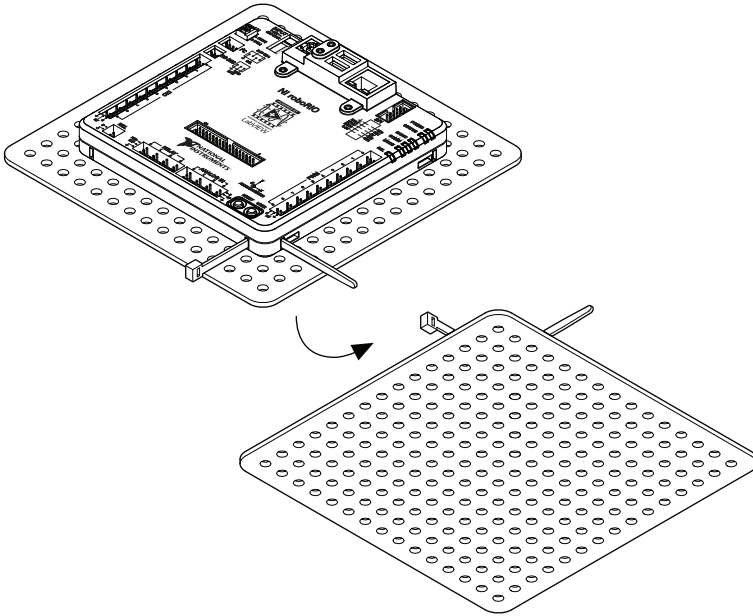

Figure 29. Cable Ties, Method Two, Step Three

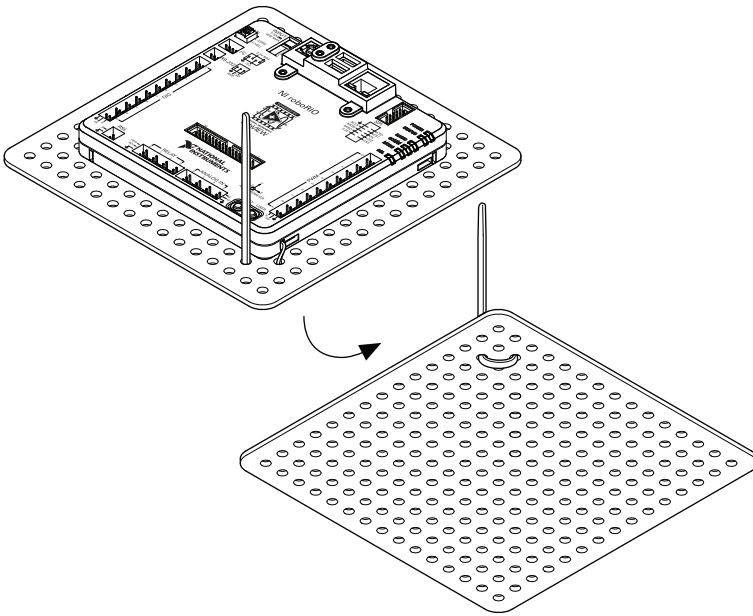

Figure 30. Cable Ties, Method Two, Step Four

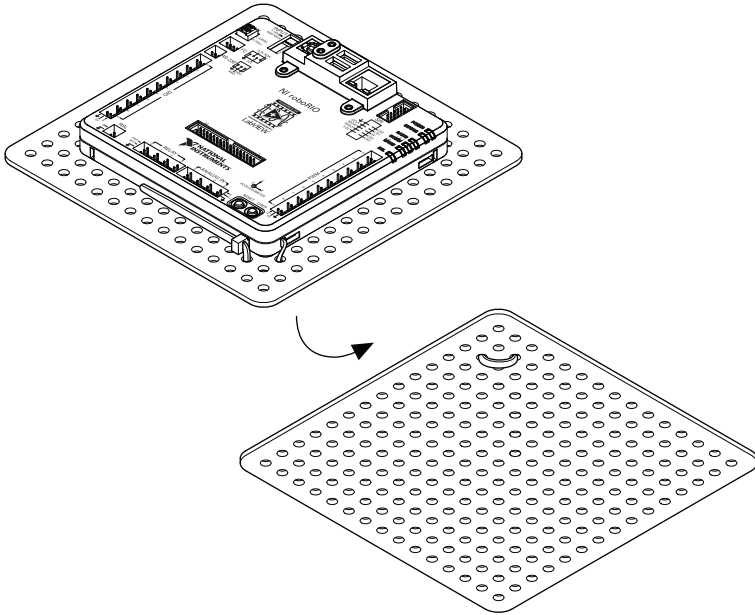
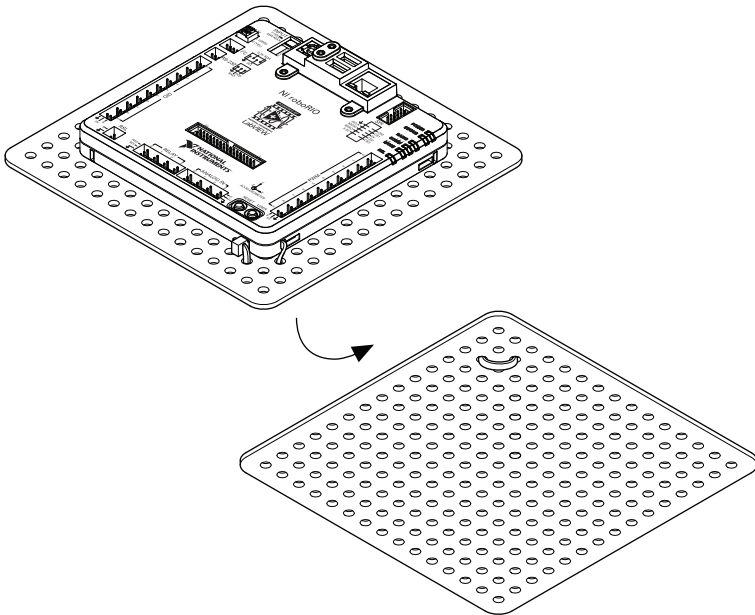

Figure 31. Cable Ties, Method Two, Step Five



Method Three: Using Screws to Secure the Bottom of the NI roboRIO to a Metal Plate

Figure 32 shows how to secure the bottom of the NI roboRIO to a metal plate using the built-in 4-40 screw holes. The length of the screws required depends on the thickness of the plate you use. For example, if the plate is 4.76 mm (0.188 in.) thick, the recommended screw length is 7.94 mm (0.313 in.).

Figure 32. Mounting NI roboRIO Using Screws

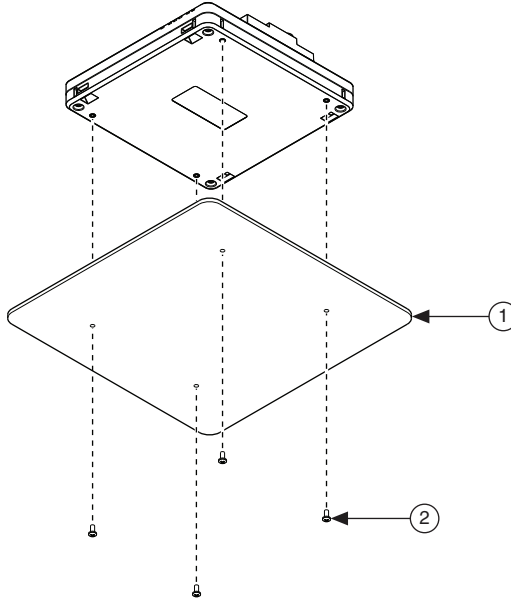

1 Metal Mounting Plate

2 4-40 Screws x 4

Compatible USB and Ethernet Cables

Table 19 lists the USB and Ethernet cables available from NI that you can use with the NI roboRIO.

Table 19. Compatible USB and Ethernet Cables Available from NI

Cable	Description	NI Part Number
USB cable	USB 2.0 A/B, black, 2 m	192256A-01
Peripheral USB cable	USB 2.0 A/A, locking, black, 2 m	152166A-01
Ethernet cable	CAT-5E, thin profile, 2 m	151733A-01

Warranty

For customers other than private individual users in the EU: The NI roboRIO is warranted against defects in materials and workmanship for a period of three years from the date of shipment, as evidenced by receipts or other documentation. National Instruments will, at its option, repair or replace equipment that proves to be defective during the warranty period. This warranty includes parts and labor.

For private individual users in the EU: Based on your statutory rights, National Instruments will—through its distributor—cure defects in materials and workmanship within two years from delivery.

Worldwide Support and Services

The National Instruments website is your complete resource for technical support. At ni.com/support you have access to everything from troubleshooting and application development self-help resources to email and phone assistance from NI Application Engineers.

Visit ni.com/services for NI Factory Installation Services, repairs, extended warranty, and other services.

Visit ni.com/register to register your National Instruments product. Product registration facilitates technical support and ensures that you receive important information updates from NI.

A Declaration of Conformity (DoC) is our claim of compliance with the Council of the European Communities using the manufacturer's declaration of conformity. This system affords the user protection for electromagnetic compatibility (EMC) and product safety. You can obtain the DoC for your product by visiting ni.com/certification. If your product supports calibration, you can obtain the calibration certificate for your product at ni.com/calibration.

National Instruments corporate headquarters is located at 11500 North Mopac Expressway, Austin, Texas, 78759-3504. National Instruments also has offices located around the world. For telephone support in the United States, create your service request at ni.com/support or dial 1 866 ASK MYNI (275 6964). For telephone support outside the United States, visit the Worldwide Offices section of ni.com/niglobal to access the branch office websites, which provide up-to-date contact information, support phone numbers, email addresses, and current events.

Refer to the *NI Trademarks and Logo Guidelines* at ni.com/trademarks for more information on National Instruments trademarks. Other product and company names mentioned herein are trademarks or trade names of their respective companies. For patents covering National Instruments products/technology, refer to the appropriate location: **Help»Patents** in your software, the `patents.txt` file on your media, or the *National Instruments Patents Notice* at ni.com/patents. You can find information about end-user license agreements (EULAs) and third-party legal notices in the readme file for your NI product. Refer to the *Export Compliance Information* at ni.com/legal/export-compliance for the National Instruments global trade compliance policy and how to obtain relevant HTS codes, ECCNs, and other import/export data. NI MAKES NO EXPRESS OR IMPLIED WARRANTIES AS TO THE ACCURACY OF THE INFORMATION CONTAINED HEREIN AND SHALL NOT BE LIABLE FOR ANY ERRORS. U.S. Government Customers: The data contained in this manual was developed at private expense and is subject to the applicable limited rights and restricted data rights as set forth in FAR 52.227-14, DFAR 252.227-7014, and DFAR 252.227-7015.

© 2014 National Instruments. All rights reserved.