SA1500X Safety, Environmental, and Regulatory Information

2022-07-08



Contents

About the SA1500X..... 3

About the SA1500X

This guide describes how to use the SA1500X active probe and contains specifications and safety, environmental, and regulatory information.

Read this document for information about installation, configuration, and operation of this equipment before you install, configure, operate, or maintain this product. Users are required to familiarize themselves with installation and wiring instructions in addition to requirements of all applicable codes, laws, and standards.

Figure 1. SA1500X

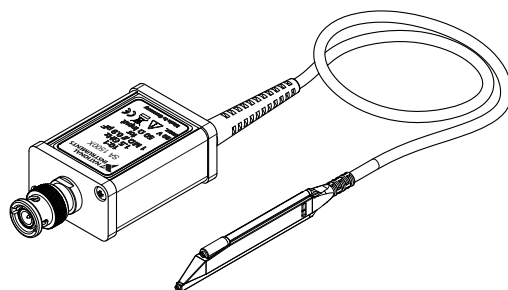

Caution Observe all instructions and cautions in the user documentation. Using the model in a manner not specified can damage the model and compromise the built-in safety protection. Return damaged models to NI for repair.





Attention Suivez toutes les instructions et respectez toutes les mises en garde de la documentation utilisateur. L'utilisation d'un modèle de toute autre façon que celle spécifiée risque de l'endommager et de compromettre la protection de sécurité intégrée. Renvoyez les modèles endommagés à NI pour réparation.

Icons



Notice Take precautions to avoid data loss, loss of signal integrity, degradation of performance, or damage to the model.

	Caution Take precautions to avoid injury. Consult the model documentation for cautionary statements when you see this icon printed on the model. Cautionary statements are localized into French for compliance with Canadian requirements.
	Protective Conductor Terminal (PE) Indicates a terminal that connects to accessible dead metal parts of the model. Connect the PE terminal(s) to an earth ground system (protective conductor) for safety.
	Functional Earth Terminal (FE) Indicates a terminal that connects to a measurement or control circuit. Connect FE terminals to an earth ground system for any functional purpose other than safety.

Getting Started

Verifying the Kit Contents

<ul style="list-style-type: none"> ▪ Calibration certificate ▪ Calibration date sticker ▪ Ground blade ▪ Ground lead (6 cm) ▪ Ground lead (12 cm) ▪ Ground lead 90° (5 cm) ▪ Ground lead 90° (10 cm) ▪ Ground leaf ▪ 2 × hook ▪ L-in adapter 	<ul style="list-style-type: none"> ▪ 4 × marker band ▪ PCB adapter ▪ Power supply, FRIWO FW8000M/24 ▪ Probe ▪ 2 × self-adhesive copper pad (2 cm × 2 cm) ▪ Solid tip ▪ Spring tip ▪ User guide (this document) ▪ Y-lead-to-0.8 mm socket adapter ▪ Z-ground
--	---

Safety

To avoid personal injury and to prevent fire or damage to the SA1500X, review and comply with the following information.



Caution The protection provided by the model can be impaired if it is used in a manner not described in the user documentation.



Attention La protection apportée par le modèle risque d'être endommagée s'il est utilisé d'une autre façon que celle décrite dans la documentation utilisateur.



Caution The accessories supplied with the probe have been safety tested. Do not use any accessories other than those provided.



Attention Les accessoires fournis avec la sonde ont subi des tests de sécurité. N'utilisez aucun autre accessoire que ceux fournis.



Caution Connect the probe ground lead to earth ground; use ground lead only for connections to earth ground. Always make sure the probe and the measurement instrument are grounded properly.



Attention Reliez le fil de terre de la sonde à la terre; n'utilisez le fil de terre que pour les connexions à la terre. Assurez-vous toujours que la sonde et l'instrument de mesure sont correctement mis à la terre.



Caution Connect the probe output to the measurement instrument and connect the ground lead to earth ground before connecting the probe to the circuit under test. Disconnect the probe input and the probe ground lead from the circuit under test before disconnecting the probe from the measurement instrument.



Attention Connectez la sortie de la sonde à l'instrument de mesure et connectez le fil de terre à la terre avant de connecter la sonde au circuit à tester. Déconnectez l'entrée de la sonde et le fil de terre de la sonde du circuit à tester avant de déconnecter la sonde de l'instrument de mesure.



Caution Do not exceed the maximum ratings of the probe. Comply with the voltage versus frequency derating curve in [Figure 3](#).



Attention Ne dépassez pas les valeurs de spécifications maximales de la sonde. Respectez la courbe de réduction de charge représentant la tension en fonction de la fréquence de la [Figure 3](#).



Caution Avoid open circuitry. Do not touch connections or components when power is present.



Attention Évitez les circuits ouverts. Ne touchez pas les connexions ou les composants lorsque le matériel est sous tension.



Caution Do not operate the probe with suspected failures.



Attention N'utilisez pas la sonde en cas de suspicion de défaillances.

Using the Probe

Operating Basics

The SA1500X is system-independent; its standard BNC connector can be plugged into any measuring instrument with a 50 Ω input. The SA1500X is suitable for measurements in all frequency ranges.

The T-shaped housing allows many probes to be positioned next to each other in a chain, which allows for many simultaneous measurements. Adjacent SA1500X active probes can contact square pins to 2.54 mm pitch.

When using the SA1500X, ensure that the input coupling of the measuring instrument is set to 50 Ω and that the SA1500X is connected to the power supply.

The SA1500X is protected against electrostatic discharge voltage (ESD).



Notice

To ensure accurate performance and protection, avoid mechanical shock to the probe. Do not bend or pull the probe cable.

Due to the nature of open probes, there may be susceptibility to outside interference.

When to Calibrate the SA1500X

The first time the SA1500X requires user calibration depends on how much time has elapsed between its factory calibration and the first time you use the probe.

Complete the following steps to determine when you need to perform your first calibration of the SA1500X.

1. Refer to **Date Calibrated** on the calibration certificate included in your kit. This is the date of the probe's factory calibration.
2. Compare the date you are first using the probe to the date of the factory calibration, and perform your initial calibration as follows:

First-Time Use of Probe	When to Calibrate
<1 year after factory calibration	No more than one year after first-time use
≥1 year, <2 years after factory calibration	No more than two years after factory calibration
≥2 years after factory calibration	Before first-time use

Once you have determined the next calibration date, mark the date on the sticker supplied with the probe and apply the sticker to the side of the probe. Perform subsequent calibrations of the SA1500X at one-year intervals.

Related concepts

- [Calibration](#)

Maintenance

To clean the exterior of the probe, use a soft cloth moistened with either distilled water or isopropyl alcohol. Allow the probe to dry completely before use.

Specifications

Definitions and Conditions

Specifications are typical and are published as general information to the user.

Specifications are valid under the following conditions unless otherwise noted.

- SA1500X warmed up for at least 30 minutes
- Environmental conditions within the probe's specified limits

Electrical Specifications

Attenuation ratio	10:1, $\pm 0.5\%$ (DC)
Dynamic measuring range	± 8 V
Bandwidth (probe only)	1.5 GHz
Maximum rated input voltage	20 V



Notice Applying input voltages outside the specified limits can destroy the probe's amplifier.

- To counter harmonic distortion and avoid input linearity errors, the maximum amplitude of the input signal should not exceed the dynamic measuring range limits stated by [Figure 1](#).

- To avoid damage to the probe, the maximum amplitude of the input signal may not exceed the maximum input voltage limits stated by [Figure 1](#).

Related reference

- [Safety Voltage](#)
- [Calibration](#)

Input Impedance

Figure 2. SA1500X Typical Input Impedance. Input impedance decreases as the frequency of the applied signal increases.

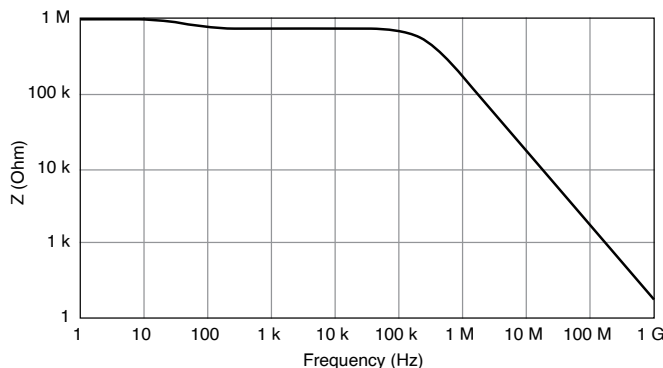

Electrical Characteristics

Input resistance (system)	>1 M Ω (DC)
Input capacitance (system)	0.9 pF
Oscilloscope input coupling	50 Ω AC/DC
Power	
Power supply voltage	24 V DC

Required current

150 mA

Safety Voltage

Connect only voltages that are below these limits.

Voltage

|Peaks| ≤20 V

Figure 3. SA1500X Maximum Input Voltage Versus Frequency. Derate voltage according to the frequency of the signal you are measuring.

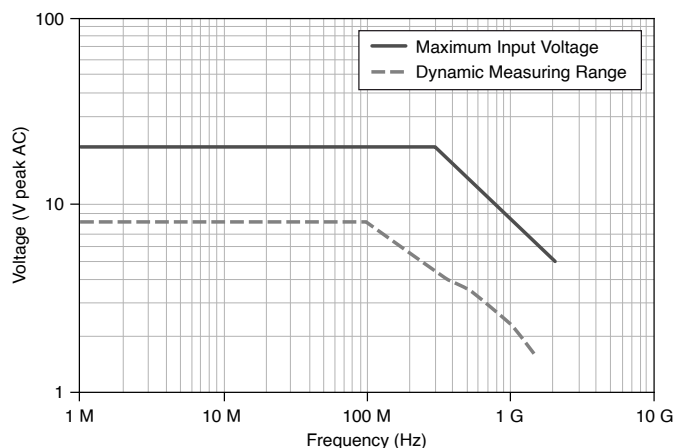

Measurement Category

CAT 0



Caution Do not connect the SA1500X to signals or use for measurements within Measurement Categories II, III, or IV.



Attention Ne connectez pas le SA1500X à des signaux et ne l'utilisez pas pour effectuer des mesures dans les catégories de mesure II, III ou IV.

Measurement Category I is for measurements performed on circuits not directly connected to the electrical distribution system referred to as **MAINS** voltage. MAINS is a hazardous live electrical supply system that powers equipment. This category is for measurements of voltages from specially protected secondary circuits. Such

voltage measurements include signal levels, special equipment, limited-energy parts of equipment, circuits powered by regulated low-voltage sources, and electronics.



Note Measurement Categories CAT I and CAT O are equivalent. These test and measurement circuits are for other circuits not intended for direct connection to the MAINS building installations of Measurement Categories CAT II, CAT III, or CAT IV.

Related reference

- [Electrical Specifications](#)

Environmental Characteristics

Temperature and Humidity

Temperature	
Operating	0 °C to 45 °C
Storage	-40 °C to 71 °C
Humidity, operating	80% relative up to 31 °C, decreasing linearly to 50% at 45°C
Pollution Degree	2
Maximum altitude	
Operating	2,000 m
Storage	15,000 m

Physical Characteristics

Weight (probe only)	96 g
Cable length	1.3 m

Calibration

This section contains calibration information and verification procedures for the SA1500X.

Verification confirms whether the probe is operating within published specifications. If the probe performs outside of the limits defined in the verification procedures, return the probe to NI for repair.

Refer to [NI Services](#) for more information on contacting NI.

Related tasks

- [When to Calibrate the SA1500X](#)

Related reference

- [Electrical Specifications](#)

Test Equipment

Refer to [Table 1](#) and [Table 2](#) for a list of necessary equipment and, where applicable, model recommendations for calibration of the SA1500X.

If you do not have the recommended equipment, select a substitute calibration standard using the specifications listed in the Requirements column.

Equipment	Recommended Model	Where Used	Requirements
2 × DMM	NI PXIe-4082	Verifying DC Accuracy (× 2)	<ul style="list-style-type: none"> ▪ Measurement error: <125 ppm ▪ Resolution: <1 μV

Equipment	Recommended Model	Where Used	Requirements
		<u>Verifying Zero Offset</u> (× 1)	<ul style="list-style-type: none"> Measurement error: <math>\lt; \pm 25 \mu\text{V}</math> Resolution: <math>\lt; 1 \mu\text{V}</math>
Precision DC source	NI PXIe-5413	<u>Verifying DC Accuracy</u>	DC signal generation: $\pm 5 \text{ V}$

Table 1. Required Instrumentation

Equipment	Where Used	Requirements
2 × BNC (m)-to-SMA (m) adapter	<u>Verifying DC Accuracy</u>	Impedance: 50 Ω
BNC tee (f-f-f)	<u>Verifying DC Accuracy</u>	Impedance: 50 Ω
BNC (m)-to-BNC (m) cable	<u>Verifying DC Accuracy</u>	Impedance: 50 Ω
2 × 4 mm double banana (m)-to-BNC (f) adapter	<ul style="list-style-type: none"> <u>Verifying DC Accuracy</u> (× 2) <u>Verifying Zero Offset</u> (× 1) 	Impedance: 50 Ω
BNC feed-through terminator	<ul style="list-style-type: none"> <u>Verifying DC Accuracy</u> <u>Verifying Zero Offset</u> 	Impedance: 50 Ω
SMA (f)-to-probe tip adapter	<u>Verifying DC Accuracy</u>	 <p>Note These connectors are not included in the probe kit. Contact PMK Mess- und Kommunikationstechnik GmbH to purchase these calibration accessories.</p>
Probe inputs shorting adapter	<u>Verifying Zero Offset</u>	

Table 2. Required Cables and Connectors

Test Conditions

The following setup conditions are required to ensure the SA1500X meets published specifications:

- Allow all test instruments a warm-up time of at least the amount of time stated in their specifications documents.
- Allow the SA1500X a warm-up time of at least 30 minutes.

Calibration Overview

Refer to [When to Calibrate the SA1500X](#) to determine when you first need to calibrate the SA1500X.

Complete the following to verify that the performance of your SA1500X is within specification:

- [Verifying DC Accuracy](#)
- [Verifying Zero Offset](#)

Required Software for Calibration

- NI-DMM (PXIe-4082 first supported in NI-DMM 15.2)
- NI-FGEN (PXIe-5413 first supported in NI-FGEN 17.1)
- Supported application development environment, such as LabVIEW or LabVIEW NXG

Verifications



Notice The connectors on the probe and test equipment are fragile. Perform the steps in these procedures with great care to prevent damaging the probe or any test equipment.

Verifying DC Accuracy

1. Connect the test system as follows:

Figure 4. Verifying DC Accuracy Test Connections

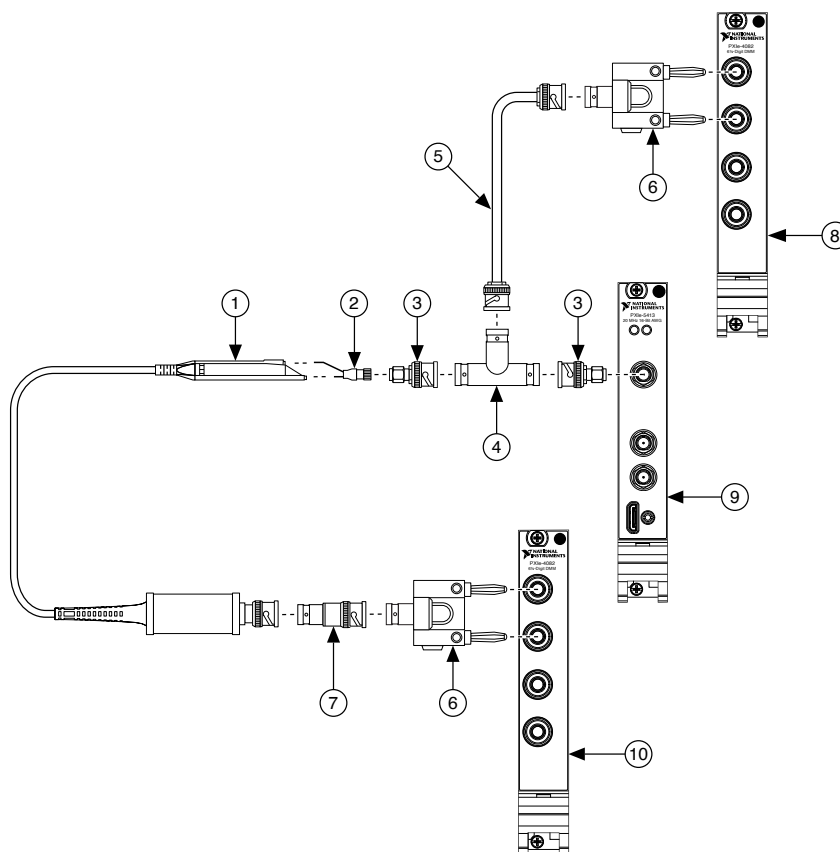

1. SA1500X
2. SMA (f)-to-probe tip adapter
3. BNC (m)-to-SMA (m) adapter
4. BNC (f-f-f) tee
5. BNC (m)-to-BNC (m) cable
6. Double banana (m)-to-BNC (f) adapter
7. BNC feed-through terminator
8. DMM 1 (HI and LO)
9. DC source (CH 0)
10. DMM 2 (HI and LO)

2. Connect power to the SA1500X and warm up the probe for at least 30 minutes.
3. Configure the DMMs with the following settings:

Setting	DMM 1	DMM 2
Function	DC Voltage	
Resolution	6.5 digits	
Number of Averages	4	
Auto Zero	Enabled	
Range	10 V	1 V

4. Output a 5 V DC signal from the DC source.
5. Measure the 5 V signal with DMM 1; measure the output of the probe with DMM 2.
6. Calculate the following:

$$\frac{\text{Reading}_{\text{DMM 1}}}{10} - \text{Reading}_{\text{DMM 2}}$$
7. Verify that the result is <500 μV .

If the reading is outside this verification limit, return the probe to NI for repair. Refer to [NI Services](#) for more information on contacting NI.

Verifying Zero Offset

1. Connect the test system as follows:

Figure 5. Verifying Zero Offset Test Connections

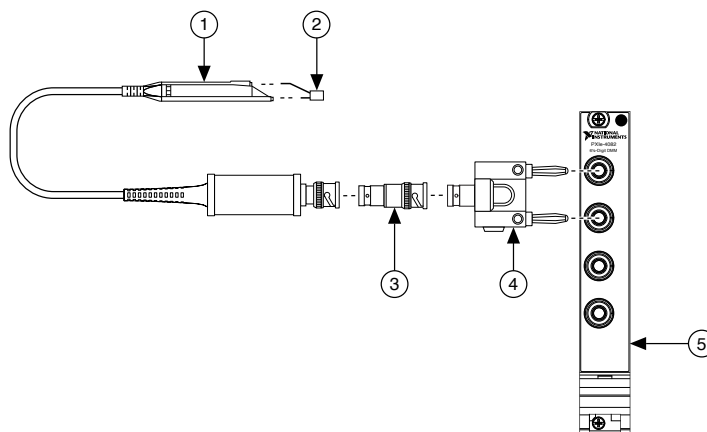

1. SA1500X
 2. Probe inputs shorting adapter
 3. BNC feed-through terminator
 4. Double banana (m)-to-BNC (f) adapter
 5. DMM (HI and LO)
2. Connect power to the SA1500X and warm up the probe for at least 30 minutes.
 3. Configure the DMM with the following settings:
 - Function: DC voltage
 - Resolution: 6.5 digits
 - Number of Averages: 4
 - Auto Zero: Enabled
 - Range: 100 mV
 4. Measure the signal at the DMM.
 5. Verify that the DMM reading is $\pm 100 \mu\text{V}$.

If the reading is outside this verification limit, return the probe to NI for repair. Refer to [NI Services](#) for more information on contacting NI.

Compliance and Certifications

Environmental Guidelines



Notice This model is intended for use in indoor applications only.

Environmental Management

NI is committed to designing and manufacturing products in an environmentally responsible manner. NI recognizes that eliminating certain hazardous substances from our products is beneficial to the environment and to NI customers.

For additional environmental information, refer to the **Engineering a Healthy Planet** web page at ni.com/environment. This page contains the environmental regulations and directives with which NI complies, as well as other environmental information not included in this document.

EU and UK Customers

- 
 Waste Electrical and Electronic Equipment (WEEE)—At the end of the product life cycle, all NI products must be disposed of according to local laws and regulations. For more information about how to recycle NI products in your region, visit ni.com/environment/weee.

电子信息产品污染控制管理办法 (中国 RoHS)

- 
 中国 RoHS— NI 符合中国电子信息产品中限制使用某些有害物质指令(RoHS)。关于 NI 中国 RoHS 合规性信息，请登录 ni.com/environment/rohs_china。(For information about China RoHS compliance, go to ni.com/environment/rohs_china.)

CE Compliance

This product meets the essential requirements of applicable European Directives, as follows:

- 2014/30/EU; Electromagnetic Compatibility Directive (EMC)
- 2011/65/EU; Restriction of Hazardous Substances (RoHS)

Product Certifications and Declarations

Refer to the product Declaration of Conformity (DoC) for additional regulatory compliance information. To obtain product certifications and the DoC for NI products, visit ni.com/product-certifications, search by model number, and click the appropriate link.

NI Services

Visit ni.com/support to find support resources including documentation, downloads, and troubleshooting and application development self-help such as tutorials and examples.

Visit ni.com/services to learn about NI service offerings such as calibration options, repair, and replacement.

Visit ni.com/register to register your NI product. Product registration facilitates technical support and ensures that you receive important information updates from NI.

NI corporate headquarters is located at 11500 N Mopac Expwy, Austin, TX, 78759-3504, USA.