

2392637-1 ✓ ACTIVE

TE Internal #: 2392637-1

Hand Crimping Tools, Commercial Crimp Tooling, Operator Releasable & Adjustable, Removable/Interchangeable, TE Product Specification (114-), Manual

[View on TE.com >](#)



Application Tooling > Hand Crimping Tools



Tool Grade: **Commercial Crimp Tooling**

Ratchet Configuration: **Operator Releasable & Adjustable**

Die Sets Type: **Removable/Interchangeable**

Specification Type: **TE Product Specification (114-)**

TE Certification: **Cannot be Certified**

## Features

### Other

Crimp Form-Wire Barrel Type	Open Barrel - F Crimp
Tool Grade	Commercial Crimp Tooling
Ratchet Configuration	Operator Releasable & Adjustable
Die Sets Type	Removable/Interchangeable
Specification Type	TE Product Specification (114-)
TE Certification	Cannot be Certified
Power Technology Type	Manual
Tooling Type	SDE Crimp Hand Tool

## Product Compliance

[For compliance documentation, visit the product page on TE.com>](#)

EU RoHS Directive 2011/65/EU	Out of Scope
EU ELV Directive 2000/53/EC	Out of Scope
China RoHS 2 Directive MIIT Order No 32, 2016	No Restricted Materials Above Threshold
EU REACH Regulation (EC) No. 1907/2006	Current ECHA Candidate List: JUNE 2022 (224) Not Yet Reviewed
Halogen Content	Not Yet Reviewed for halogen content
Solder Process Capability	Not applicable for solder process capability



Product Compliance Disclaimer

This information is provided based on reasonable inquiry of our suppliers and represents our current actual knowledge based on the information they provided. This information is subject to change. The part numbers that TE has identified as EU RoHS compliant have a maximum concentration of 0.1% by weight in homogenous materials for lead, hexavalent chromium, mercury, PBB, PBDE, DBP, BBP, DEHP, DIBP, and 0.01% for cadmium, or qualify for an exemption to these limits as defined in the Annexes of Directive 2011/65/EU (RoHS2). Finished electrical and electronic equipment products will be CE marked as required by Directive 2011/65/EU. Components may not be CE marked. Additionally, the part numbers that TE has identified as EU ELV compliant have a maximum concentration of 0.1% by weight in homogenous materials for lead, hexavalent chromium, and mercury, and 0.01% for cadmium, or qualify for an exemption to these limits as defined in the Annexes of Directive 2000/53/EC (ELV). Regarding the REACH Regulation, the information TE provides on SVHC in articles for this part number is based on the latest European Chemicals Agency (ECHA) 'Guidance on requirements for substances in articles' posted at this URL: <https://echa.europa.eu/guidance-documents/guidance-on-reach>

## Compatible Parts



TE Part # CAT-T4827-T273  
TIMER, RECEPTACLE AND TAB



TE Part # 2392637-2  
SDE F JR/STD TIMER 1.5-2.5mm2 DIE SET



TE Part # 927888-2  
CI 2 STIFT

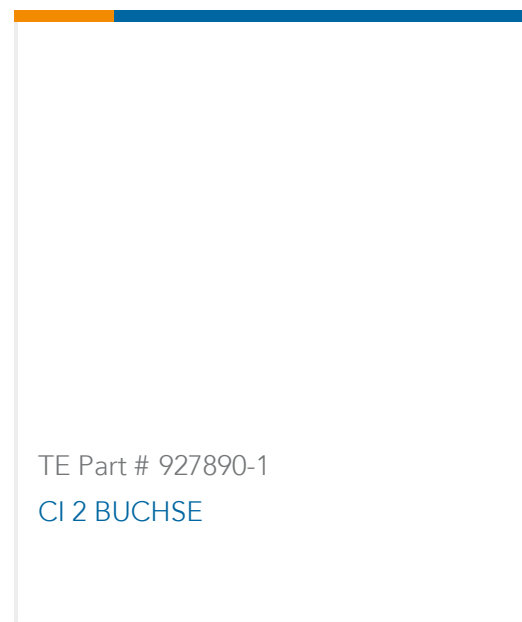

TE Part # 927890-1  
CI 2 BUCHSE



TE Part # 927888-1  
CI 2 STIFT

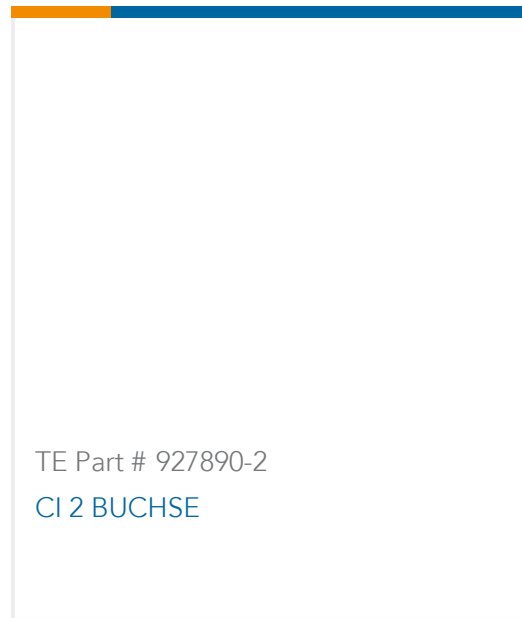

TE Part # 927890-2  
CI 2 BUCHSE



TE Part # 2362810-1  
SDE CRIMP HAND TOOL FRAME W /O DIES

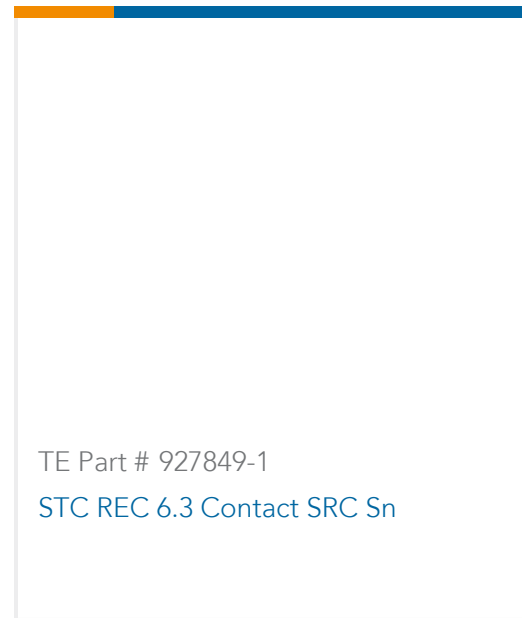

TE Part # 927849-1  
STC REC 6.3 Contact SRC Sn



TE Part # 927850-1  
STD TIMER CONTACT (LP)

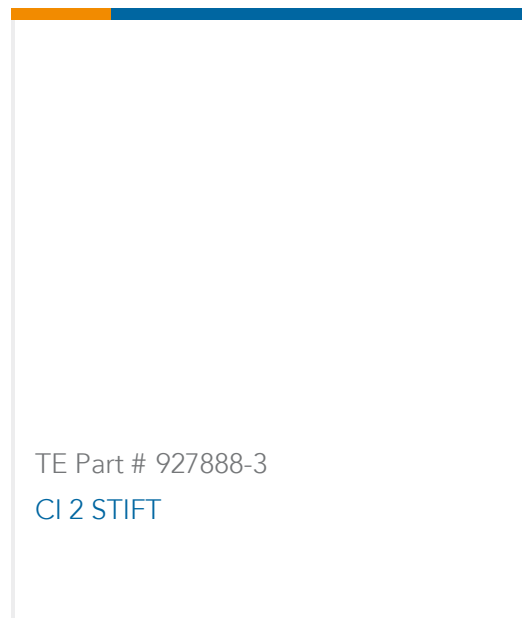

TE Part # 927888-3  
CI 2 STIFT

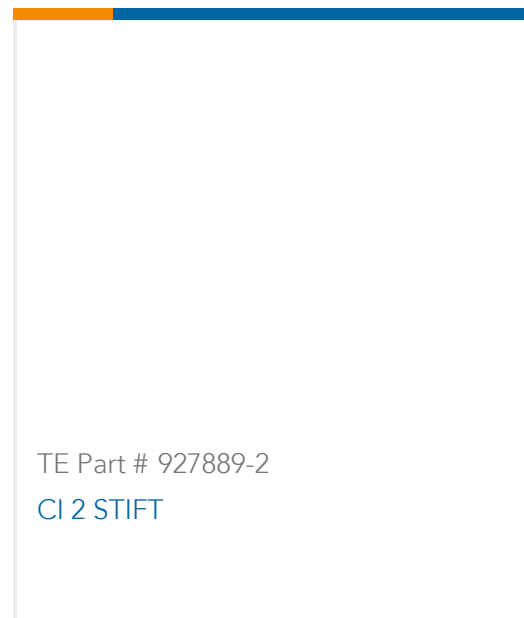

TE Part # 927889-2  
CI 2 STIFT

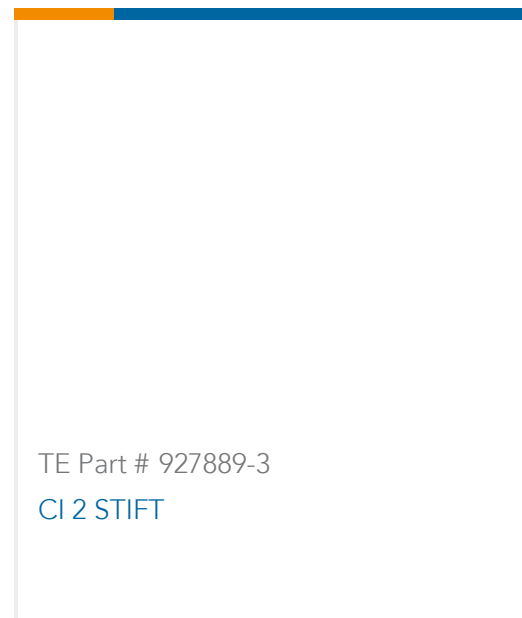

TE Part # 927889-3  
CI 2 STIFT

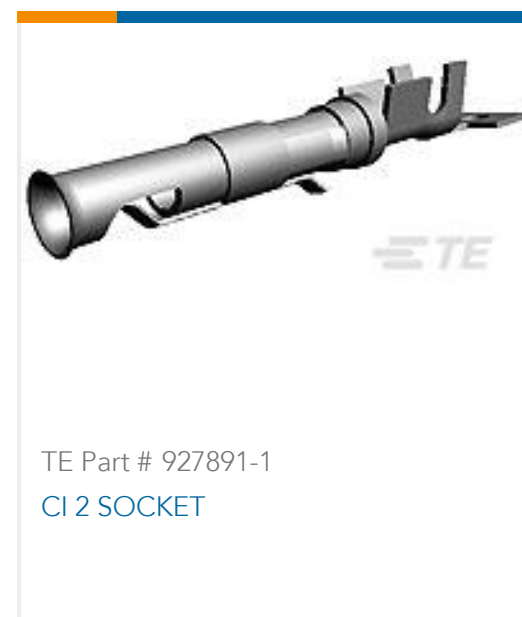
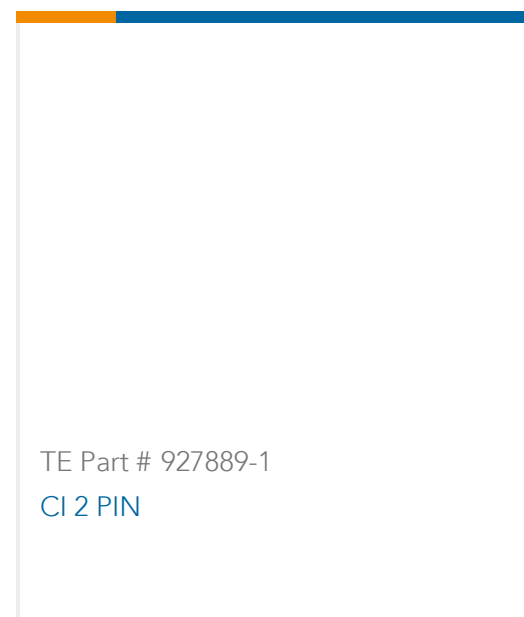
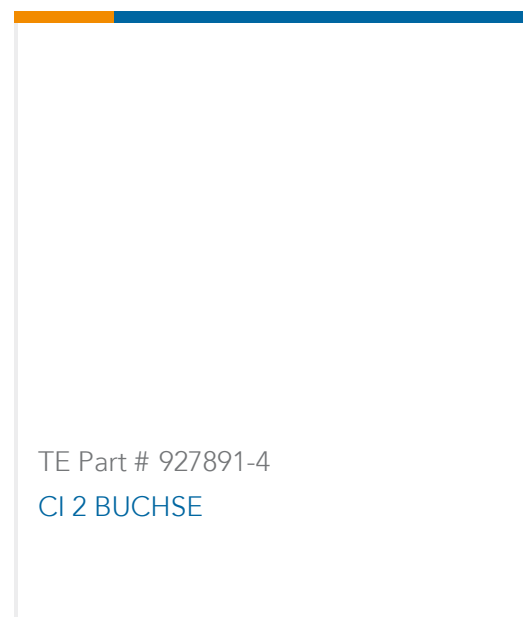
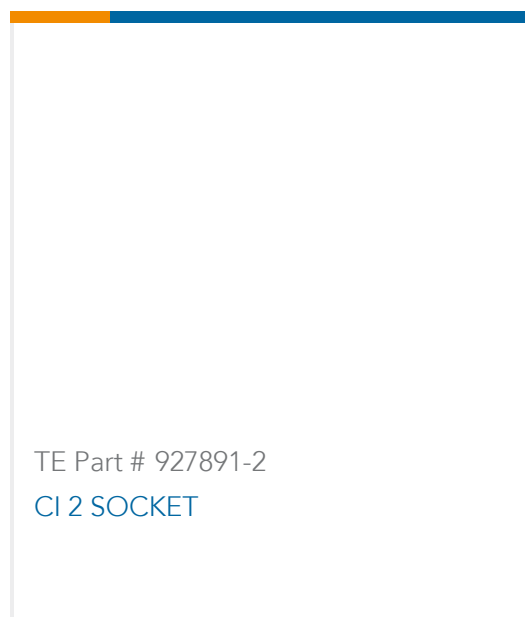

## Documents

### Datasheets & Catalog Pages

#### Bottoming Dies

English

#### SDE Crimp Commercial Tool System

English

### Instruction Sheets

#### Instruction Sheet (U.S.)

English