

Spring Terminated Flanged Inlet

Features

- Faster termination time
- No need for screwdriver and torque wrench
- Spring Termination eliminates strand relaxation
- Funnel shaped wire entry for ease of termination.
- Backwired termination for ease of installation

Ordering Information

Description	Device Color	UPC Number	Catalog Number
Nylon casing, back wired.	White	78358568170	HBL2525ST

Listings

Listed to UL 498
Fed.Spec. W-C-596
Certified to CSA C22.2 No.42

Specifications

Housing	Nylon
Terminal Retainer	Nylon
Plunger	Nylon
Blades	Copper Alloy
Terminal Spring Clamp	Spring Steel
Assembly Screws	Zinc Plated Tri-drive
Mounting Screw	Nickel Plated Brass, 8- 32 Thread
Weight (lbs)	0.25

Performance

Electrical	
Current Interrupting	Certified for current interrupting at full rated current
Dielectric Voltage	Withstands 3,000V minimum
Mechanical	
Terminal Accommodation	#14 AWG - #6 AWG solid or #14AWG - #8AWG stranded copper wire
Terminal Identification	Terminals identified in accordance with UL 498
Environmental	
Flammability	HB or better per UL94/CSA 22.2 No.0.17
Moisture Resistance	IP20 Suitability
Operating Temperatures	Maximum Continuous 75°C, Minimum -40°C (w/o impact)

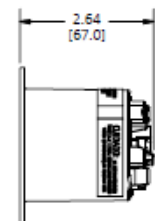
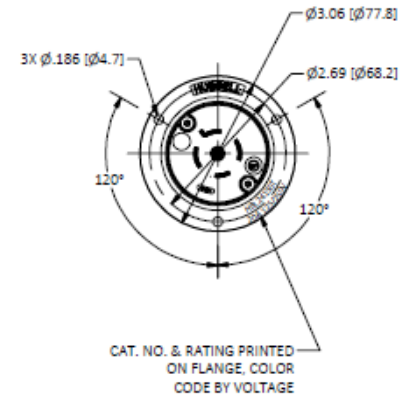

Online Resources

eCatalog