



Heterojunction Bipolar Transistor Technology (InGaP HBT)

Broadband High Linearity Amplifier

The MMG3006NT1 is a General Purpose Amplifier that is internally input prematched and designed for a broad range of Class A, small-signal, high linearity, general purpose applications. It is suitable for applications with frequencies from 400 to 2400 MHz such as Cellular, PCS, WLL, PHS, VHF, UHF, UMTS and general small-signal RF.

Features

- Frequency: 400-2400 MHz
- P1dB: 33 dBm @ 900 MHz
- Small-Signal Gain: 17.5 dB @ 900 MHz
- Third Order Output Intercept Point: 49 dBm @ 900 MHz
- Single 5 Volt Supply
- Internally Input Prematched to 50 Ohms
- RoHS Compliant
- In Tape and Reel. T1 Suffix = 1,000 Units per 12 mm, 13 inch Reel.

MMG3006NT1

**400-2400 MHz, 17.5 dB
33 dBm
InGaP HBT**

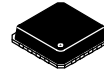

**CASE 1898-01
QFN 4x4
PLASTIC**

Table 1. Typical Performance (1)

Characteristic	Symbol	900 MHz	1960 MHz	2140 MHz	Unit
Small-Signal Gain (S21)	G_p	17.5	14	14	dB
Input Return Loss (S11)	IRL	-8	-9	-12	dB
Output Return Loss (S22)	ORL	-13	-14	-18	dB
Power Output @1dB Compression	P1db	33	33	33	dBm
Third Order Output Intercept Point	IP3	49	49	49	dBm

1. $V_{DC} = 5$ Vdc, $T_C = 25^\circ\text{C}$, 50 ohm system

Table 2. Maximum Ratings

Rating	Symbol	Value	Unit
Supply Voltage	V_{DC}	6	V
Supply Current	I_{DC}	1400	mA
RF Input Power	P_{in}	28	dBm
Storage Temperature Range	T_{stg}	-65 to +150	$^\circ\text{C}$
Junction Temperature (2)	T_J	150	$^\circ\text{C}$

2. For reliable operation, the junction temperature should not exceed 150°C .

Table 3. Thermal Characteristics ($V_{DC} = 5$ Vdc, $I_{DC} = 850$ mA, $T_C = 25^\circ\text{C}$)

Characteristic	Symbol	Value (3)	Unit
Thermal Resistance, Junction to Case	$R_{\theta JC}$	7.8	$^\circ\text{C}/\text{W}$

3. Refer to AN1955, *Thermal Measurement Methodology of RF Power Amplifiers*. Go to <http://www.freescale.com/rf>. Select Documentation/Application Notes - AN1955.

Table 4. Electrical Characteristics ($V_{DC} = 5$ Vdc, 900 MHz, $T_C = 25^\circ\text{C}$, 50 ohm system, in Freescale Application Circuit)

Characteristic	Symbol	Min	Typ	Max	Unit
Small-Signal Gain (S21)	G_p	16.5	17.5	—	dB
Input Return Loss (S11)	IRL	—	-8	—	dB
Output Return Loss (S22)	ORL	—	-13	—	dB
Power Output @ 1dB Compression	P1dB	—	33	—	dBm
Third Order Output Intercept Point	IP3	—	49	—	dBm
Noise Figure	NF	—	6.6	—	dB
Supply Current (1)	I_{DC}	760	850	960	mA
Supply Voltage (1)	V_{DC}	—	5	—	V

1. For reliable operation, the junction temperature should not exceed 150°C .

Table 5. Functional Pin Description

Name	Pin Number	Description
V _{BA}	1	Bias voltage supply.
RF _{in}	2, 3, 4	RF input for the power amplifier. This pin is DC-coupled and requires a DC-blocking series capacitor.
RF _{out} / V _{CC}	9, 10, 11, 12	RF output for the power amplifier. This pin is DC-coupled and requires a DC-blocking series capacitor.
V _{CC}	16	Collector voltage supply.
GND	Backside Center Metal	The center metal base of the QFN package provides both DC and RF ground as well as heat sink contact for the power amplifier.

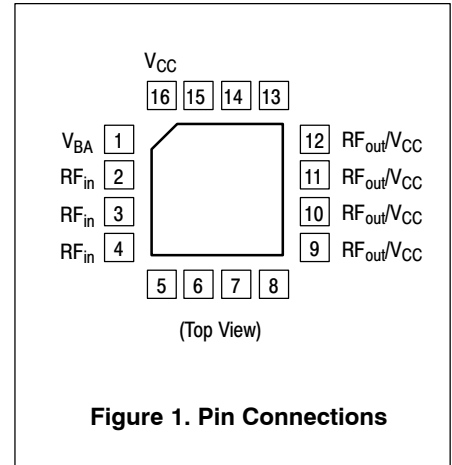

Table 6. ESD Protection Characteristics

Test Conditions/Test Methodology	Class
Human Body Model (per JESD 22-A114)	1C (Minimum)
Machine Model (per EIA/JESD 22-A115)	A (Minimum)
Charge Device Model (per JESD 22-C101)	IV (Minimum)

Table 7. Moisture Sensitivity Level

Test Methodology	Rating	Package Peak Temperature	Unit
Per JESD 22-A113, IPC/JEDEC J-STD-020	1	260	°C

50 OHM TYPICAL CHARACTERISTICS

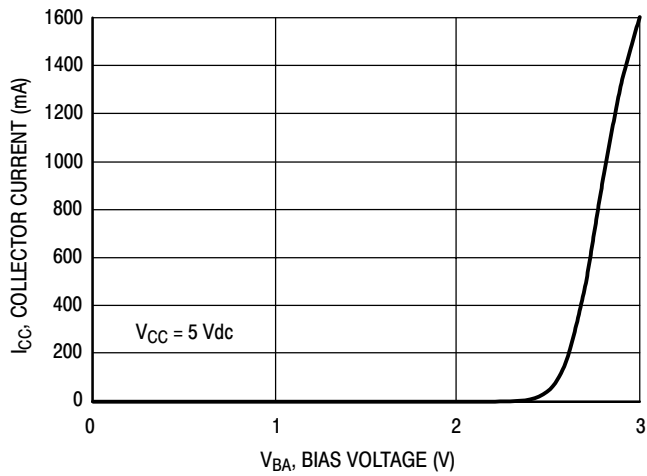
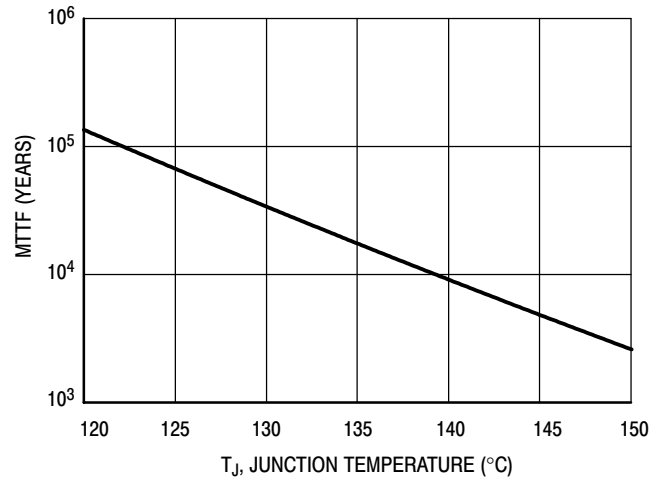

Figure 2. Collector Current versus Bias Voltage



NOTE: The MTTF is calculated with $V_{DC} = 5$ Vdc, $I_{DC} = 850$ mA

Figure 3. MTTF versus Junction Temperature

50 OHM APPLICATION CIRCUIT: 900 MHz

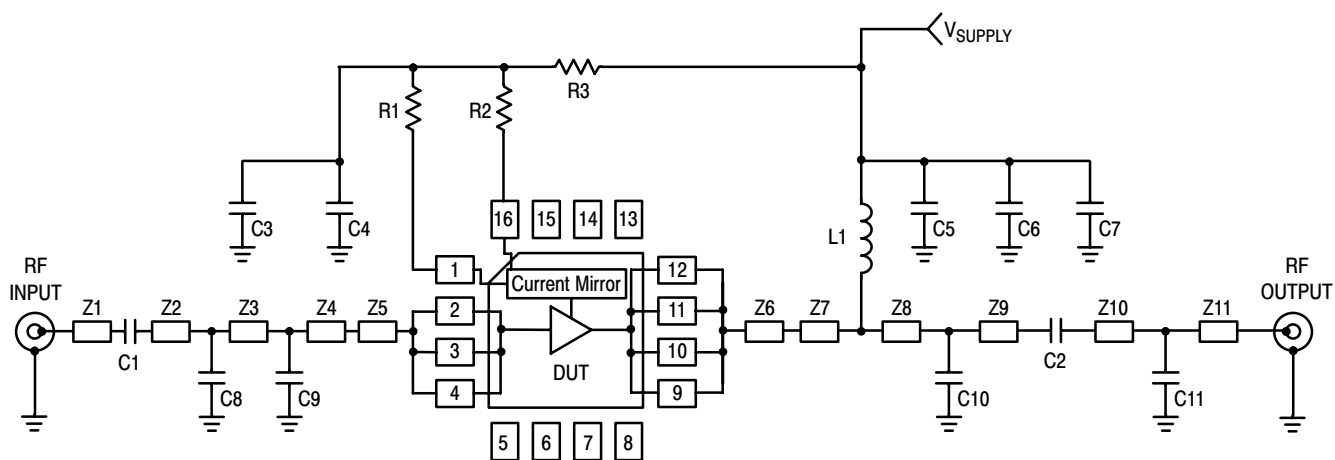

Z1	0.140" x 0.028" Microstrip	Z6	0.026" x 0.089" Microstrip
Z2, Z9, Z10	0.044" x 0.028" Microstrip	Z7	0.167" x 0.028" Microstrip
Z3	0.169" x 0.028" Microstrip	Z8	0.178" x 0.028" Microstrip
Z4	0.177" x 0.028" Microstrip	Z11	0.096" x 0.028" Microstrip
Z5	0.026" x 0.053" Microstrip	PCB	Isola FR408, 0.014", $\epsilon_r = 3.7$

Figure 4. 50 Ohm Test Circuit Schematic

Table 8. 50 Ohm Test Circuit Component Designations and Values

Part	Description	Part Number	Manufacturer
C1, C2	15 pF Chip Capacitors	ECUV1H150JCV	Panasonic
C3, C6	0.01 μ F Chip Capacitors	C0603C103J5RAC	Kemet
C4, C7	0.1 μ F Chip Capacitors	C0603C104J5RAC	Kemet
C5	2.2 μ F Chip Capacitor	T491A225K016AT	Kemet
C8	6.8 pF Chip Capacitor	06035J6R8BS	AVX
C9, C11	3.9 pF Chip Capacitors	06035J3R9BS	AVX
C10	5.6 pF Chip Capacitor	06035J5R6BS	AVX
L1	15 nH Chip Inductor	1008CS-150XJB	Coilcraft
R1	100 Ω , 1/4 W Chip Resistor	ERJ8GEYJ101V	Panasonic
R2, R3	0 Ω , 1/10 W Chip Resistors	CRCW06030000FKEA	Vishay

50 OHM APPLICATION CIRCUIT: 900 MHz

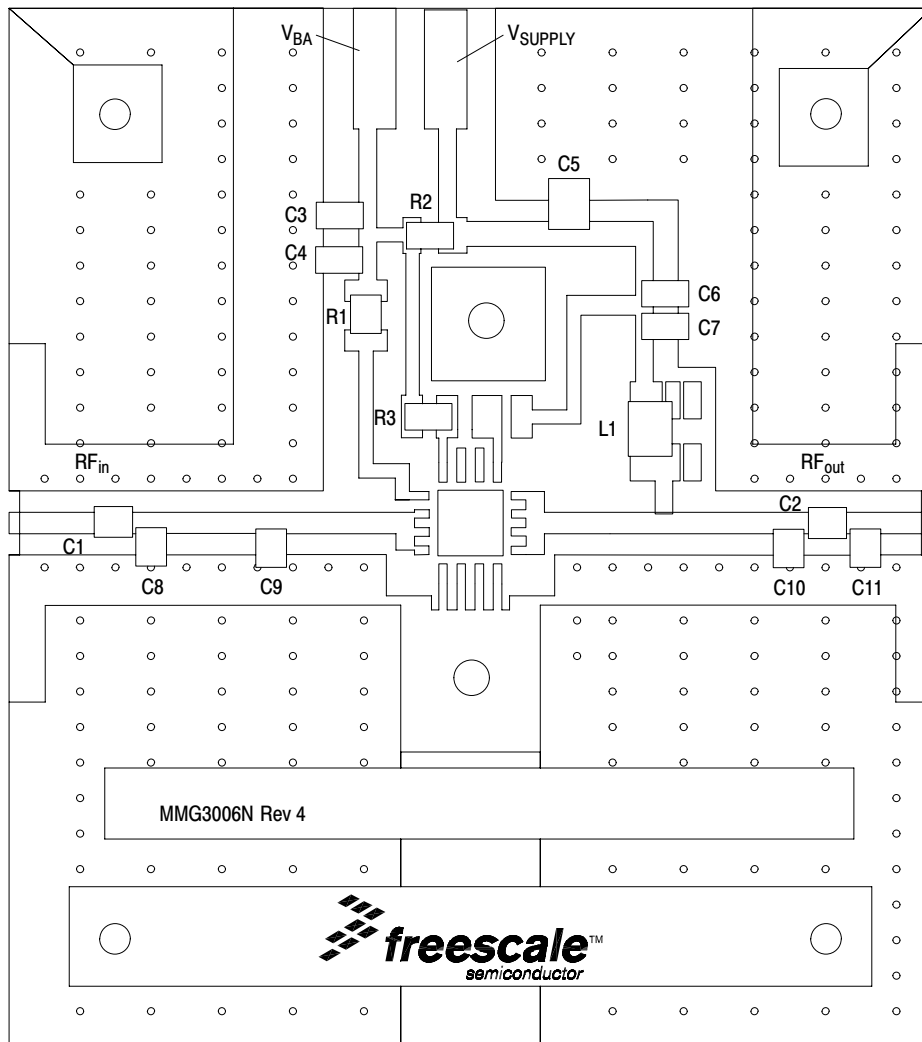

Figure 5. 50 Ohm Test Circuit Component Layout

50 OHM TYPICAL CHARACTERISTICS: 900 MHz

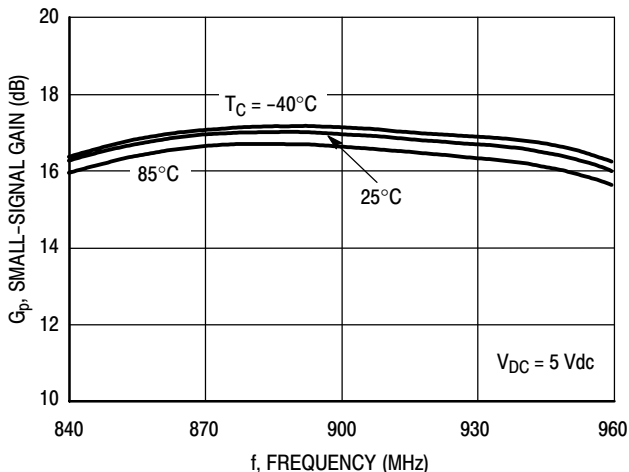

Figure 6. Small-Signal Gain (S21) versus Frequency

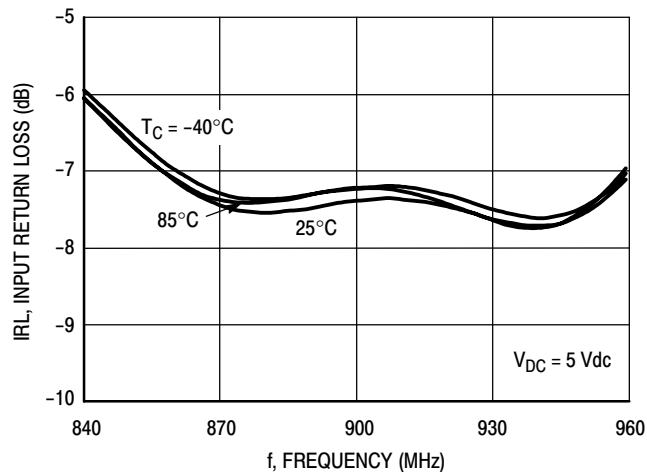

Figure 7. Input Return Loss (S11) versus Frequency

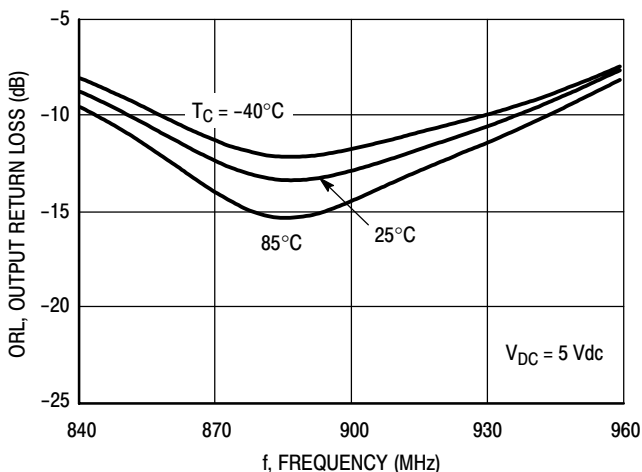

Figure 8. Output Return Loss (S22) versus Frequency

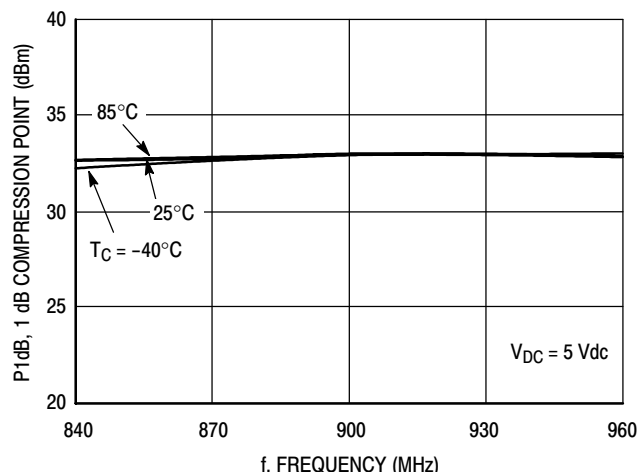

Figure 9. P1dB versus Frequency

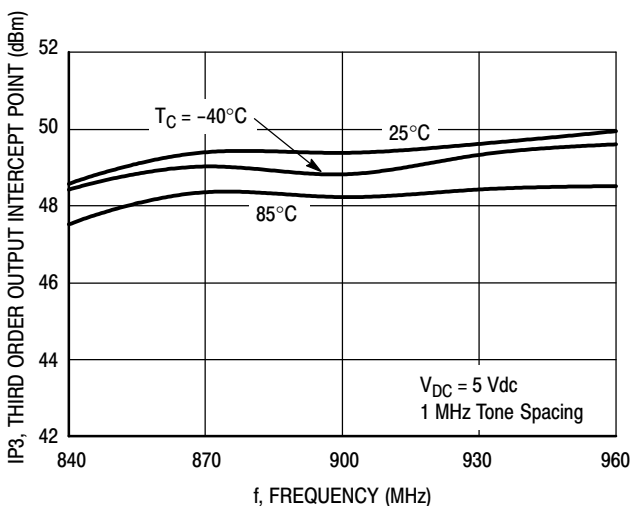

Figure 10. Third Order Output Intercept Point versus Frequency

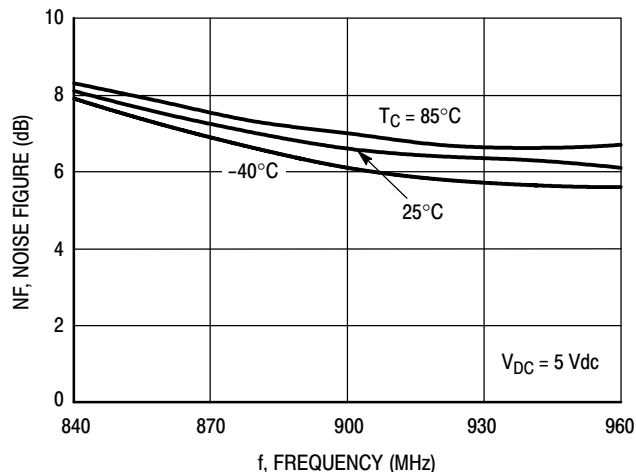

Figure 11. Noise Figure versus Frequency

50 OHM TYPICAL CHARACTERISTICS: 900 MHz

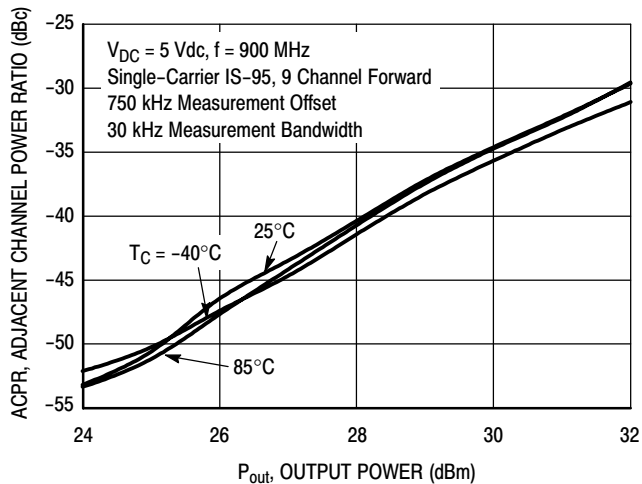

Figure 12. IS-95 Adjacent Channel Power Ratio versus Output Power

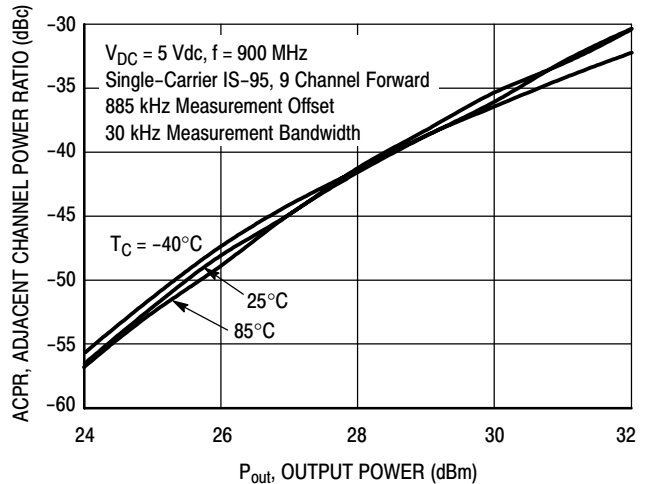

Figure 13. IS-95 Adjacent Channel Power Ratio versus Output Power

50 OHM APPLICATION CIRCUIT: 1960 MHz

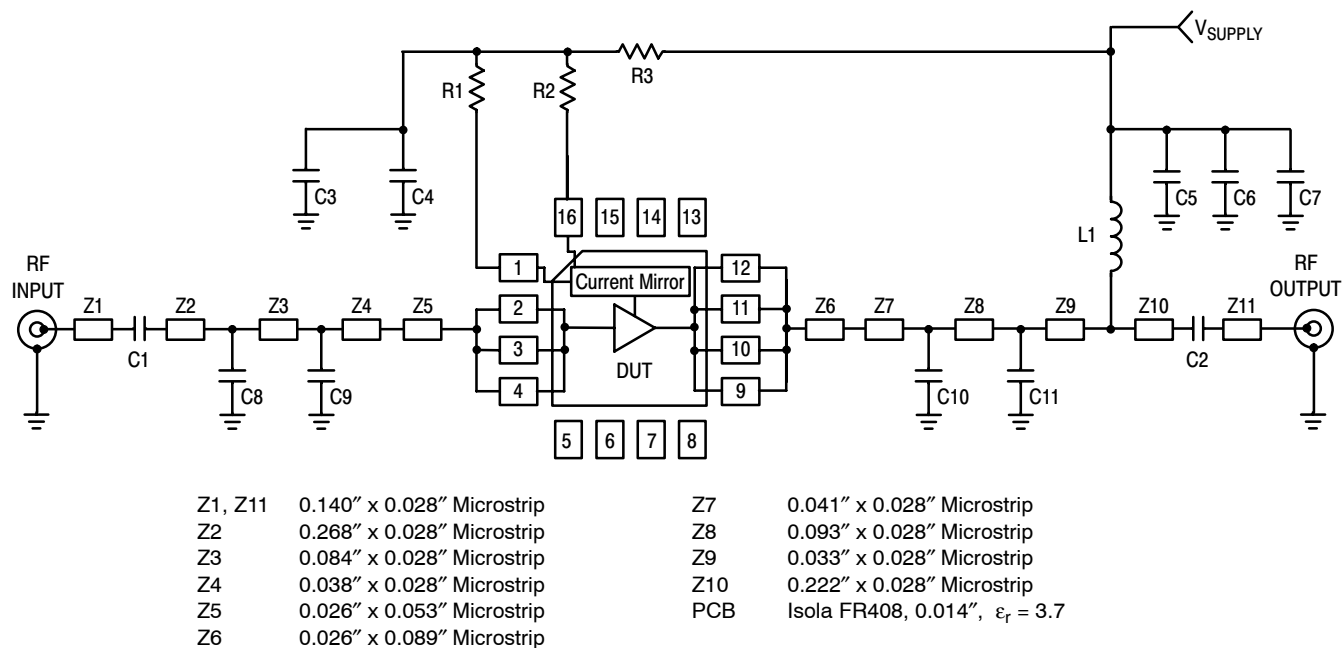

Figure 14. 50 Ohm Test Circuit Schematic

Table 9. 50 Ohm Test Circuit Component Designations and Values

Part	Description	Part Number	Manufacturer
C1, C2	15 pF Chip Capacitors	ECUV1H150JCV	Panasonic
C3, C6	0.01 μ F Chip Capacitors	C0603C103J5RAC	Kemet
C4, C7	0.1 μ F Chip Capacitors	C0603C104J5RAC	Kemet
C5	2.2 μ F Chip Capacitor	T491A225K016AT	Kemet
C8, C9	3.0 pF Chip Capacitors	06035J3R0BS	AVX
C10	2.0 pF Chip Capacitor	06035J2R0BS	AVX
C11	2.7 pF Chip Capacitor	06035J2R7BS	AVX
L1	15 nH Chip Inductor	1008CS-150XJB	Coilcraft
R1	100 Ω , 1/4 W Chip Resistor	ERJ8GEYJ101V	Panasonic
R2, R3	0 Ω , 1/10 W Chip Resistors	CRCW06030000FKEA	Vishay

50 OHM APPLICATION CIRCUIT: 1960 MHz

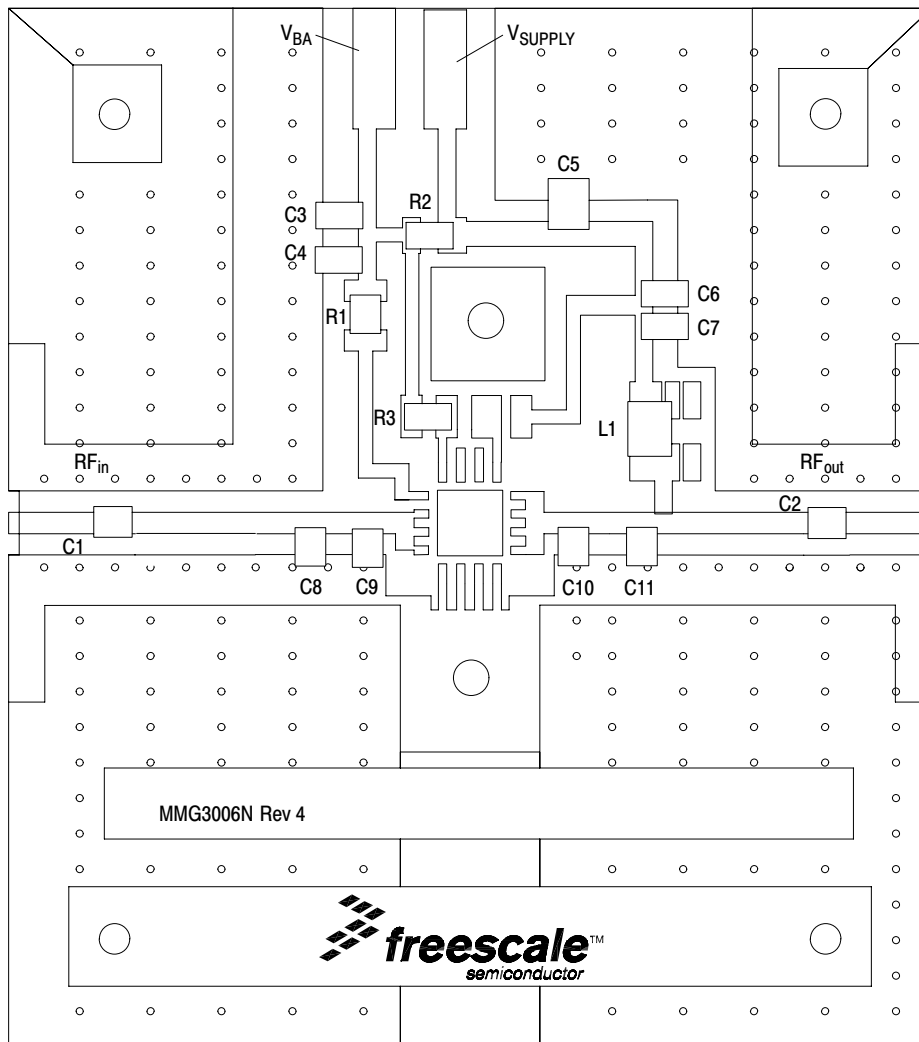

Figure 15. 50 Ohm Test Circuit Component Layout

50 OHM TYPICAL CHARACTERISTICS: 1960 MHz

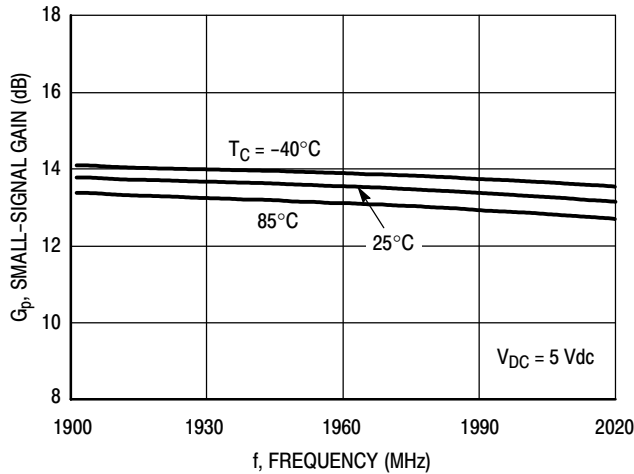

Figure 16. Small-Signal Gain (S21) versus Frequency

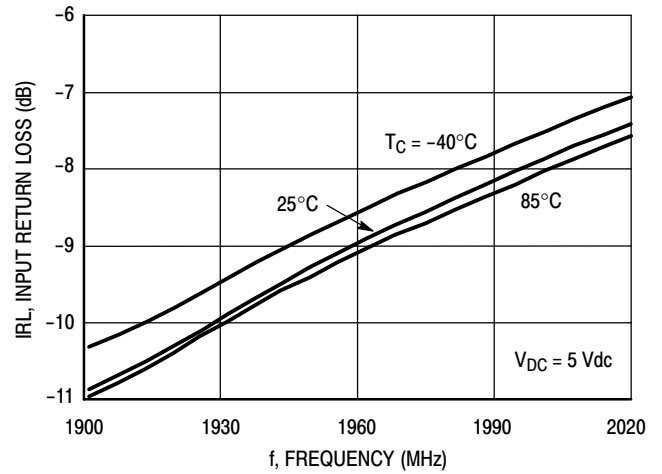

Figure 17. Input Return Loss (S11) versus Frequency

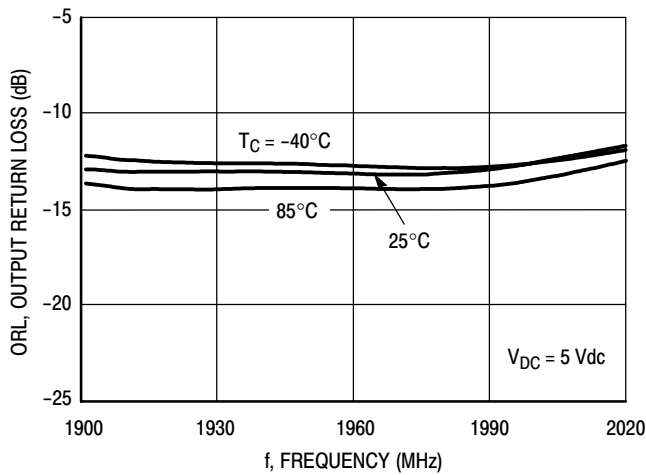

Figure 18. Output Return Loss (S22) versus Frequency

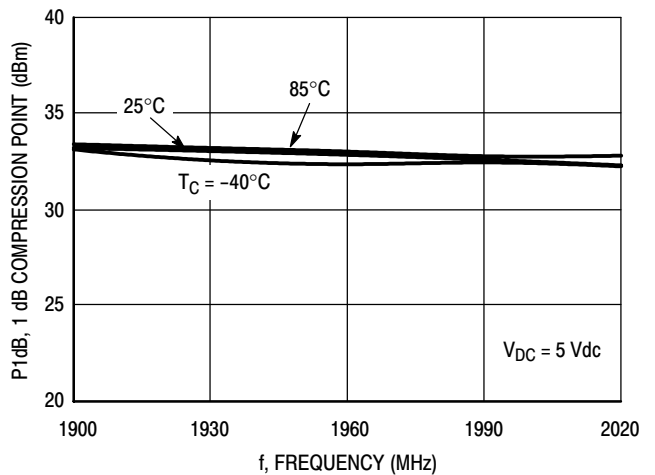

Figure 19. P1dB versus Frequency

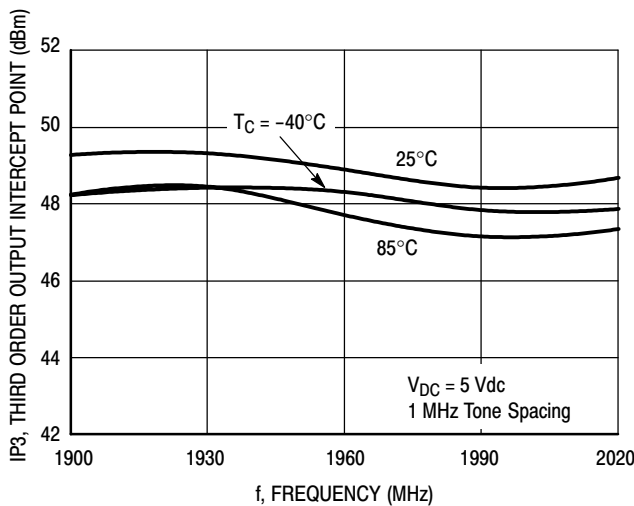

Figure 20. Third Order Output Intercept Point versus Frequency

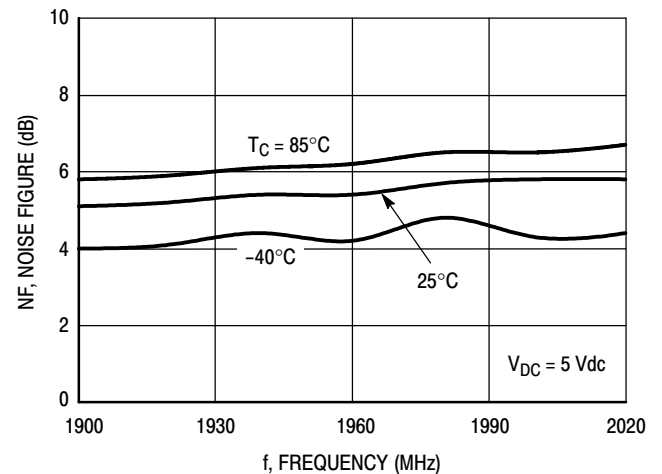

Figure 21. Noise Figure versus Frequency

50 OHM TYPICAL CHARACTERISTICS: 1960 MHz

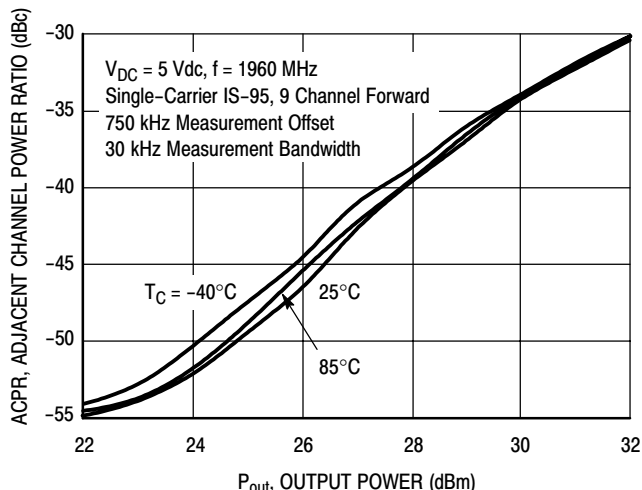

Figure 22. IS-95 Adjacent Channel Power Ratio versus Output Power

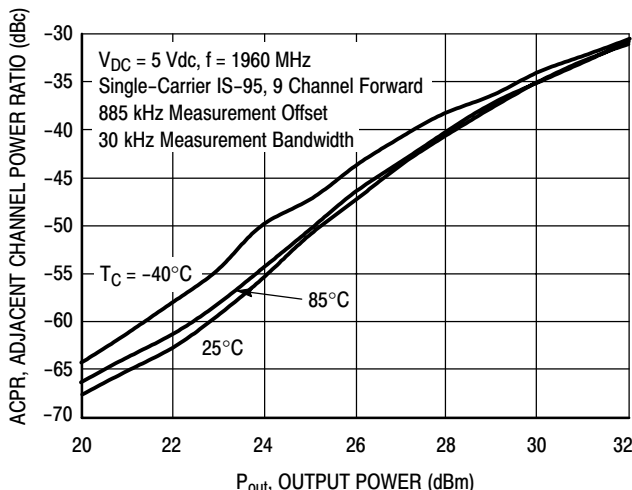

Figure 23. IS-95 Adjacent Channel Power Ratio versus Output Power

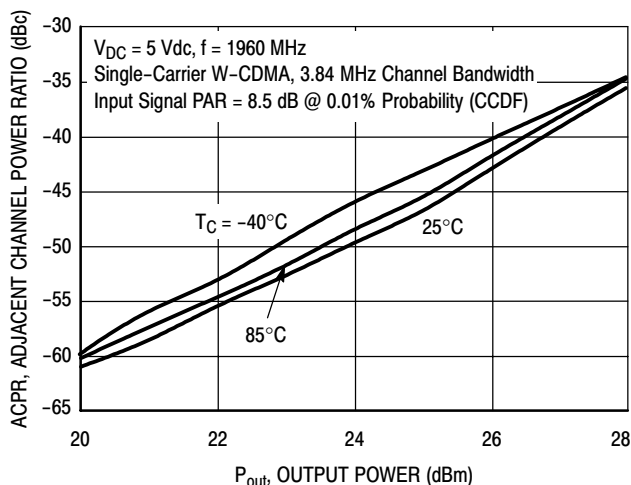

Figure 24. Single-Carrier W-CDMA Adjacent Channel Power Ratio versus Output Power

50 OHM APPLICATION CIRCUIT: 2140 MHz

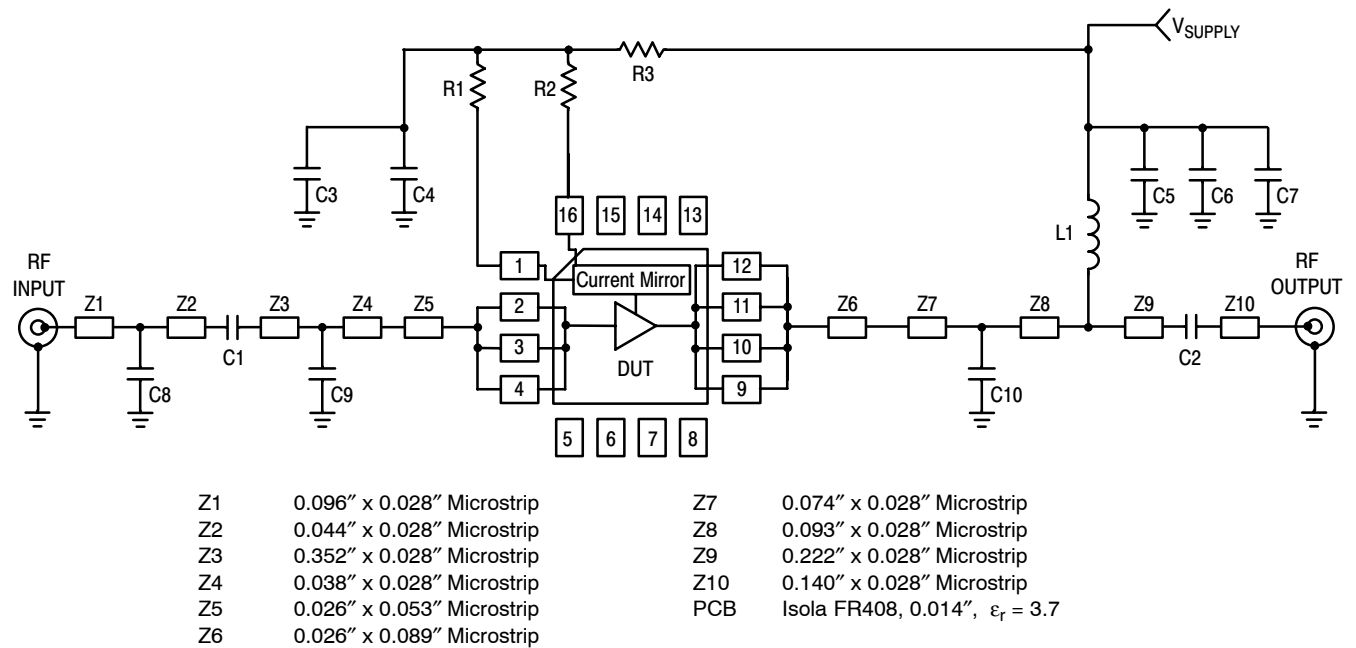

Figure 25. 50 Ohm Test Circuit Schematic

Table 10. 50 Ohm Test Circuit Component Designations and Values

Part	Description	Part Number	Manufacturer
C1, C2	15 pF Chip Capacitors	ECUV1H150JCV	Panasonic
C3, C6	0.01 μ F Chip Capacitors	C0603C103J5RAC	Kemet
C4, C7	0.1 μ F Chip Capacitors	C0603C104J5RAC	Kemet
C5	2.2 μ F Chip Capacitor	T491A225K016AT	Kemet
C8	0.5 pF Chip Capacitor	06035J0R5BS	AVX
C9	3.6 pF Chip Capacitor	06035J3R6BS	AVX
C10	3.9 pF Chip Capacitor	06035J3R9BS	AVX
L1	15 nH Chip Inductor	1008CS-150XJB	Coilcraft
R1	100 Ω , 1/4 W Chip Resistor	ERJ8GEYJ101V	Panasonic
R2, R3	0 Ω , 1/10 W Chip Resistors	CRCW06030000FKEA	Vishay

50 OHM APPLICATION CIRCUIT: 2140 MHz

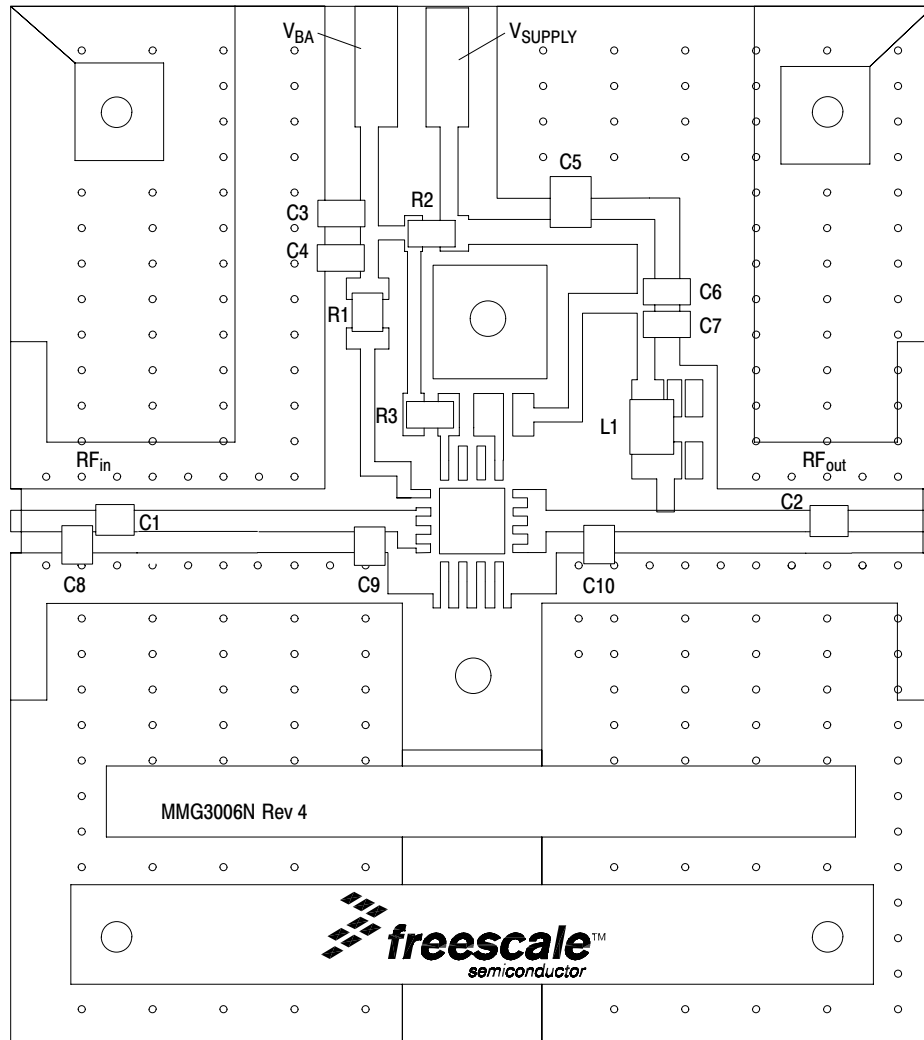

Figure 26. 50 Ohm Test Circuit Component Layout

50 OHM TYPICAL CHARACTERISTICS: 2140 MHz

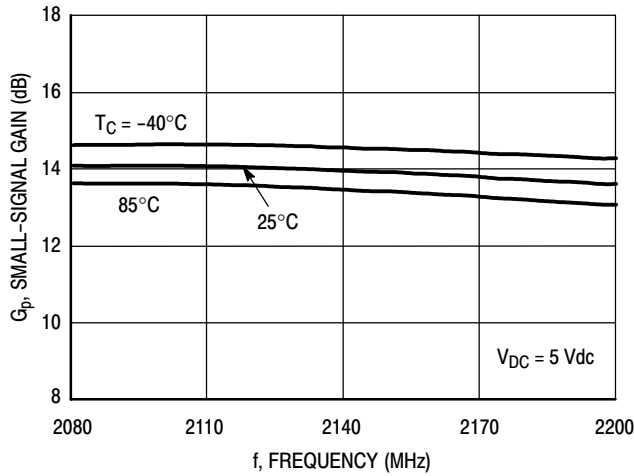

Figure 27. Small-Signal Gain (S21) versus Frequency

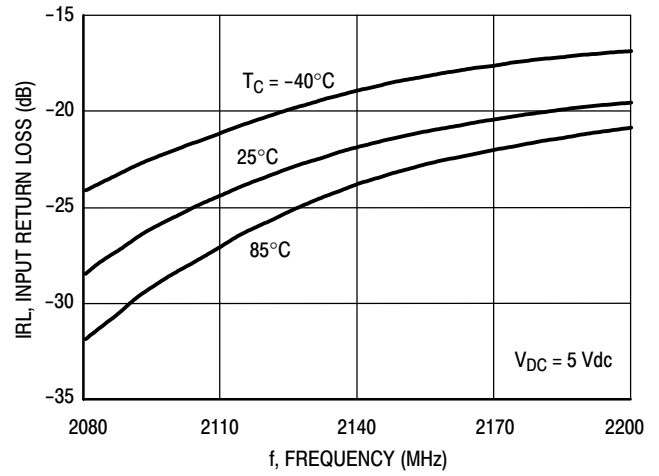

Figure 28. Input Return Loss (S11) versus Frequency

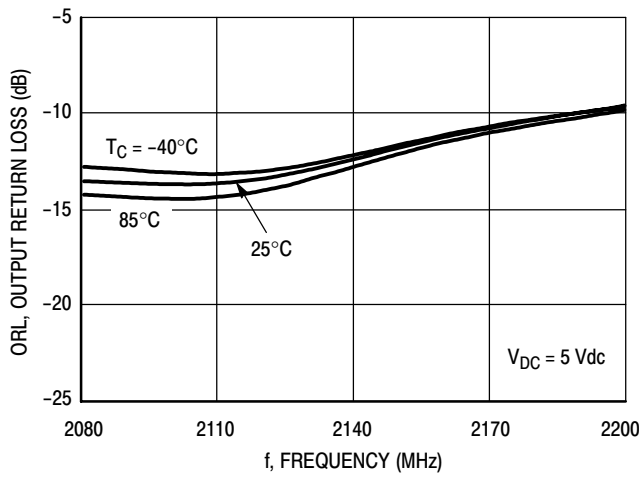

Figure 29. Output Return Loss (S22) versus Frequency

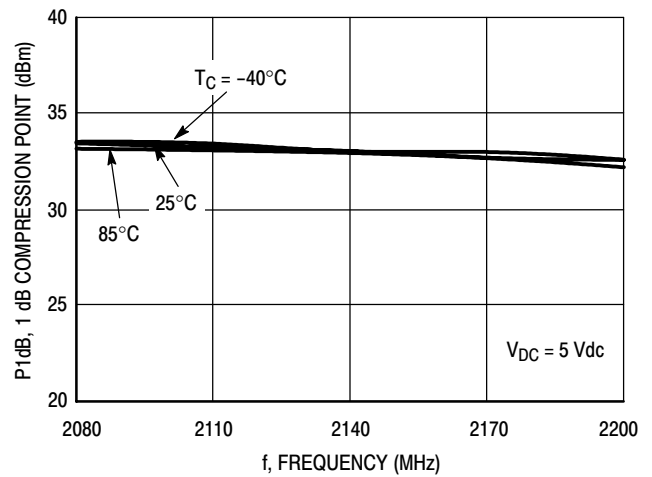

Figure 30. P1dB versus Frequency

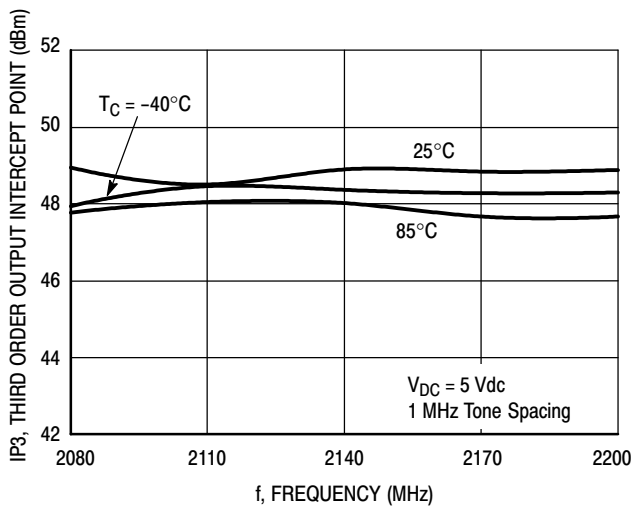

Figure 31. Third Order Output Intercept Point versus Frequency

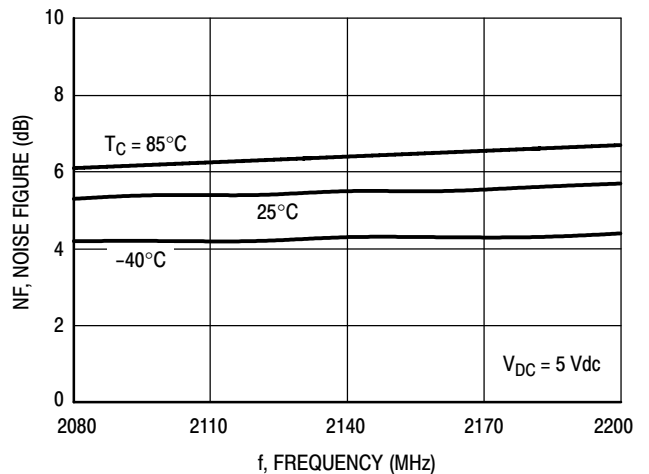

Figure 32. Noise Figure versus Frequency

50 OHM TYPICAL CHARACTERISTICS: 2140 MHz

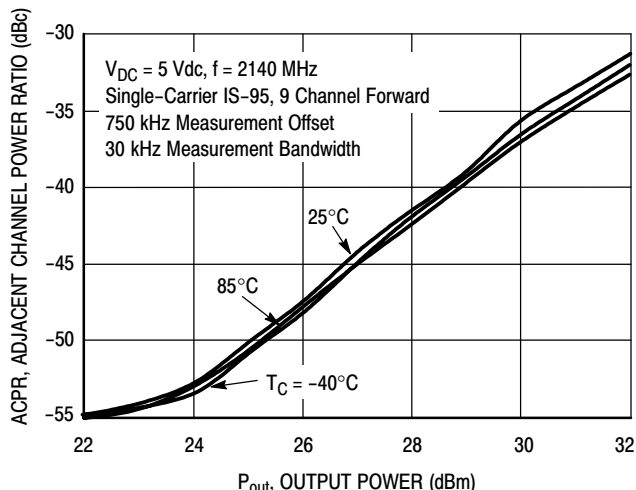

Figure 33. IS-95 Adjacent Channel Power Ratio versus Output Power

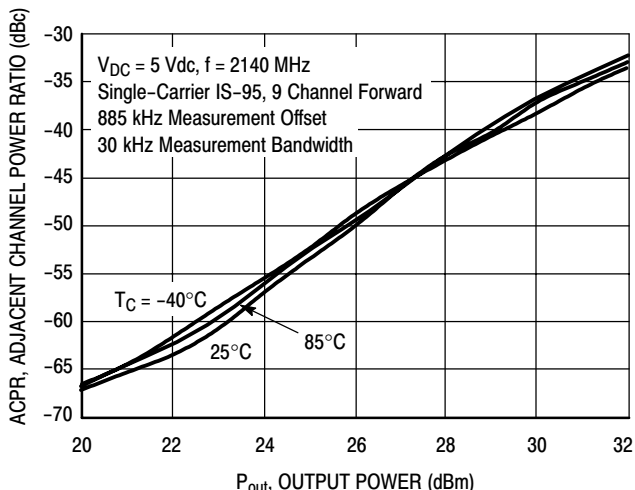

Figure 34. IS-95 Adjacent Channel Power Ratio versus Output Power

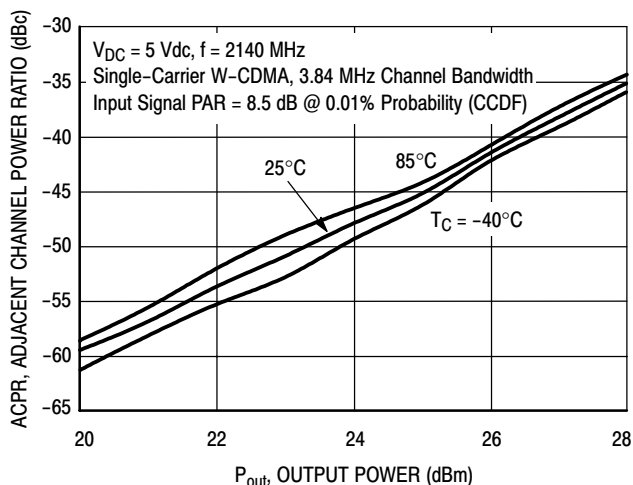

Figure 35. Single-Carrier W-CDMA Adjacent Channel Power Ratio versus Output Power

50 OHM TYPICAL CHARACTERISTICS

Table 11. Common Emitter S-Parameters ($V_{DC} = 5 \text{ Vdc}$, $I_{DC} = 850 \text{ mA}$, $T_C = 25^\circ\text{C}$, 50 Ohm System)

f MHz	S ₁₁		S ₂₁		S ₁₂		S ₂₂	
	S ₁₁	∠ φ	S ₂₁	∠ φ	S ₁₂	∠ φ	S ₂₂	∠ φ
250	0.821	-173.7	2.816	143.3	0.00597	-61.7	0.922	-179.0
300	0.841	-174.5	2.643	137.3	0.00514	-56.7	0.922	-178.9
350	0.860	-175.2	2.471	132.0	0.00455	-51.6	0.922	-179.1
400	0.872	-175.3	2.309	127.6	0.00435	-44.2	0.921	-180.0
450	0.889	-176.1	2.149	124.2	0.00371	-46.7	0.924	-179.4
500	0.900	-177.0	2.030	120.3	0.00331	-40.6	0.924	-179.6
550	0.909	-177.9	1.908	116.9	0.00306	-35.3	0.925	-179.4
600	0.917	-178.8	1.796	113.8	0.00286	-30.6	0.925	-179.4
650	0.924	-179.6	1.695	110.8	0.00269	-25.9	0.924	-179.6
700	0.930	179.6	1.605	108.2	0.00258	-20.7	0.923	-179.5
750	0.935	178.9	1.522	105.8	0.00248	-15.9	0.922	-179.6
800	0.939	178.2	1.448	103.4	0.00243	-11.1	0.921	-179.8
850	0.943	177.5	1.380	101.3	0.00240	-6.6	0.920	-179.9
900	0.946	176.9	1.320	99.2	0.00239	-2.2	0.919	180.0
950	0.949	176.3	1.266	97.2	0.00239	1.8	0.918	179.9
1000	0.951	175.7	1.216	95.2	0.00242	5.4	0.918	179.6
1050	0.953	175.2	1.172	93.4	0.00246	8.8	0.918	179.5
1100	0.954	174.6	1.133	91.5	0.00250	11.9	0.917	179.3
1150	0.956	174.1	1.098	89.7	0.00255	14.1	0.917	179.0
1200	0.957	173.6	1.067	87.8	0.00261	16.7	0.916	178.8
1250	0.958	173.1	1.039	86.0	0.00268	18.6	0.915	178.6
1300	0.958	172.6	1.015	84.3	0.00275	19.9	0.915	178.3
1350	0.958	172.2	0.994	82.4	0.00282	21.4	0.914	177.9
1400	0.959	171.7	0.978	80.5	0.00292	22.6	0.913	177.6
1450	0.958	171.3	0.964	78.5	0.00299	23.5	0.913	177.3
1500	0.957	170.9	0.952	76.5	0.00306	23.9	0.912	177.1
1550	0.957	170.5	0.945	74.3	0.00316	24.2	0.912	176.7
1600	0.955	170.0	0.941	72.0	0.00324	24.3	0.911	176.5
1650	0.954	169.7	0.941	69.6	0.00332	23.7	0.910	176.2
1700	0.951	169.2	0.944	67.0	0.00340	23.3	0.909	175.8
1750	0.949	168.8	0.951	64.1	0.00348	22.3	0.907	175.5
1800	0.945	168.4	0.969	60.9	0.00360	21.0	0.906	175.2
1850	0.942	168.1	0.975	57.4	0.00361	19.4	0.905	175.0
1900	0.937	167.7	0.985	53.5	0.00364	16.9	0.903	174.6
1950	0.932	167.3	0.999	49.0	0.00363	14.0	0.902	174.4
2000	0.925	166.9	1.016	43.7	0.00357	9.9	0.901	174.1
2050	0.918	166.4	1.034	37.5	0.00346	5.4	0.902	173.8
2100	0.910	166.0	1.048	30.2	0.00322	-0.4	0.903	173.4
2150	0.904	165.6	1.053	21.7	0.00290	-6.9	0.905	173.2
2200	0.900	165.2	1.038	11.9	0.00242	-13.5	0.910	172.9
2250	0.902	164.9	0.995	1.2	0.00178	-19.1	0.916	172.5
2300	0.910	164.4	0.922	-10.0	0.00104	-18.2	0.925	172.2
2350	0.924	164.1	0.823	-20.9	0.000474	24.3	0.933	171.9

(continued)

50 OHM TYPICAL CHARACTERISTICS

Table 11. Common Emitter S-Parameters ($V_{DC} = 5 \text{ Vdc}$, $I_{DC} = 850 \text{ mA}$, $T_C = 25^\circ\text{C}$, 50 Ohm System) (continued)

f MHz	S ₁₁		S ₂₁		S ₁₂		S ₂₂	
	S ₁₁	∠ φ	S ₂₁	∠ φ	S ₁₂	∠ φ	S ₂₂	∠ φ
2400	0.938	163.7	0.711	-30.9	0.000864	82.0	0.938	171.7
2450	0.952	163.3	0.600	-39.7	0.00152	86.3	0.943	171.4
2500	0.963	162.9	0.498	-47.0	0.00207	84.0	0.945	171.1
2550	0.970	162.5	0.408	-53.1	0.00253	80.0	0.946	170.8
2600	0.976	162.1	0.332	-58.0	0.00287	76.4	0.947	170.4
2650	0.981	161.6	0.268	-61.9	0.00316	73.4	0.945	169.0
2700	0.983	161.2	0.215	-64.8	0.00340	71.2	0.944	168.3
2750	0.986	160.8	0.170	-66.7	0.00361	69.2	0.943	167.4
2800	0.988	160.5	0.132	-67.6	0.00382	67.5	0.941	166.5
2850	0.988	160.0	0.101	-66.9	0.00402	66.1	0.940	165.9
2900	0.989	159.6	0.075	-64.1	0.00418	64.8	0.939	165.1
2950	0.990	159.2	0.053	-57.4	0.00438	63.4	0.938	164.5
3000	0.990	158.8	0.037	-43.3	0.00455	62.3	0.937	163.9

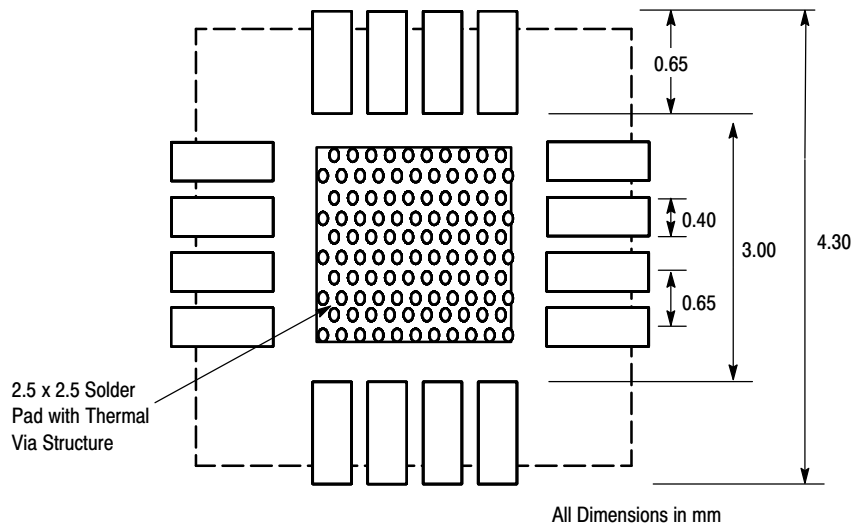

NOTES:

1. THERMAL AND RF GROUNDING CONSIDERATIONS SHOULD BE USED IN PCB LAYOUT DESIGN.
2. DEPENDING ON PCB DESIGN RULES, AS MANY VIAS AS POSSIBLE SHOULD BE PLACED ON THE BACKSIDE CENTER METAL GROUND LANDING PATTERN.
3. REFER TO FREESCALE APPLICATION NOTE AN2467 FOR ADDITIONAL PQFN PCB GUIDELINES.

Figure 36. Recommended Mounting Configuration

PACKAGE DIMENSIONS

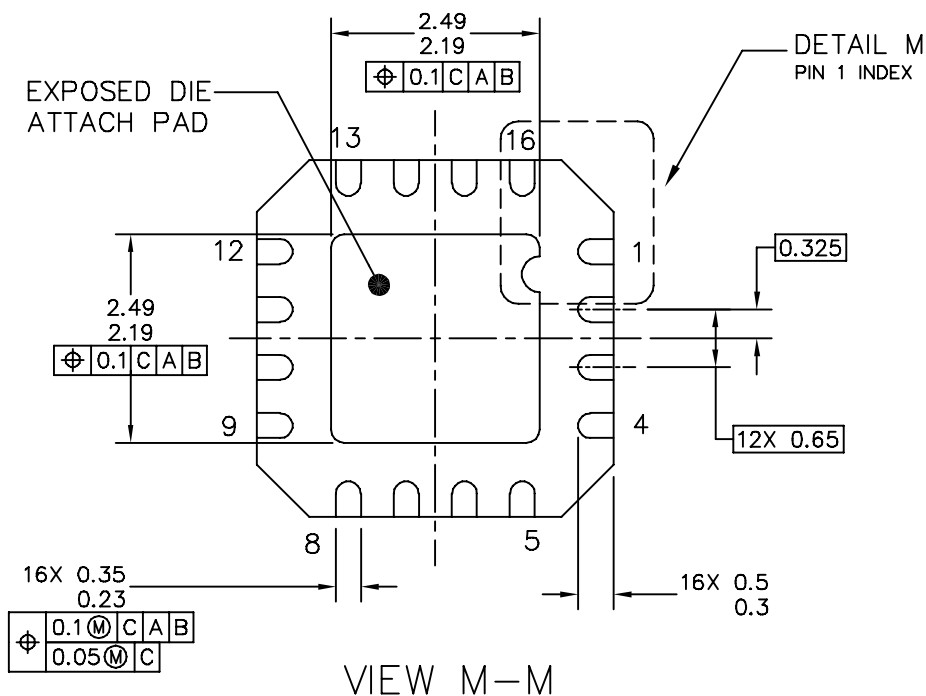
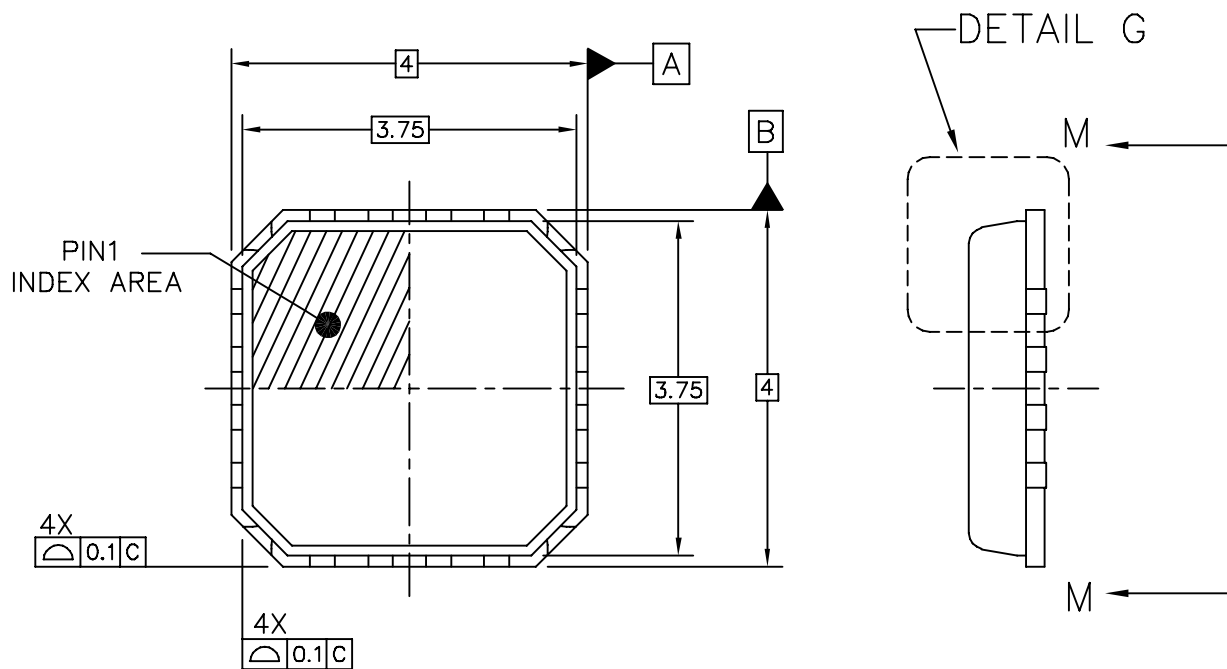

© FREESCALE SEMICONDUCTOR, INC. ALL RIGHTS RESERVED.	MECHANICAL OUTLINE	PRINT VERSION NOT TO SCALE	
TITLE: THERMALLY ENHANCED QUAD FLAT NON-LEADED PACKAGE (QFN) 16 TERMINAL, 0.65 PITCH (4 X 4 X 0.9)	DOCUMENT NO: 98ASA10761D	REV: 0	
	CASE NUMBER: 1898-01	08 SEP 2006	
	STANDARD: NON-JEDEC		

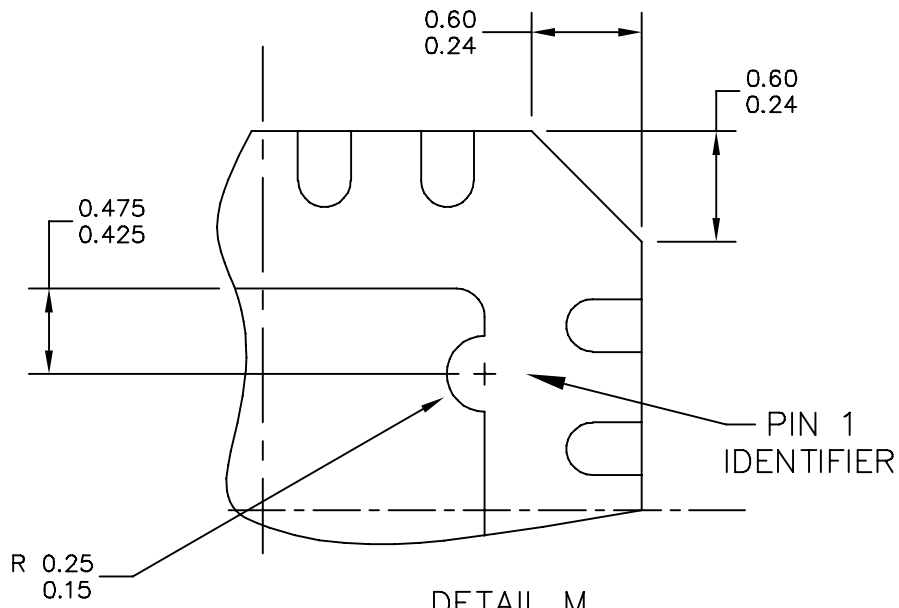

DETAIL M
PIN 1 BACKSIDE IDENTIFIER

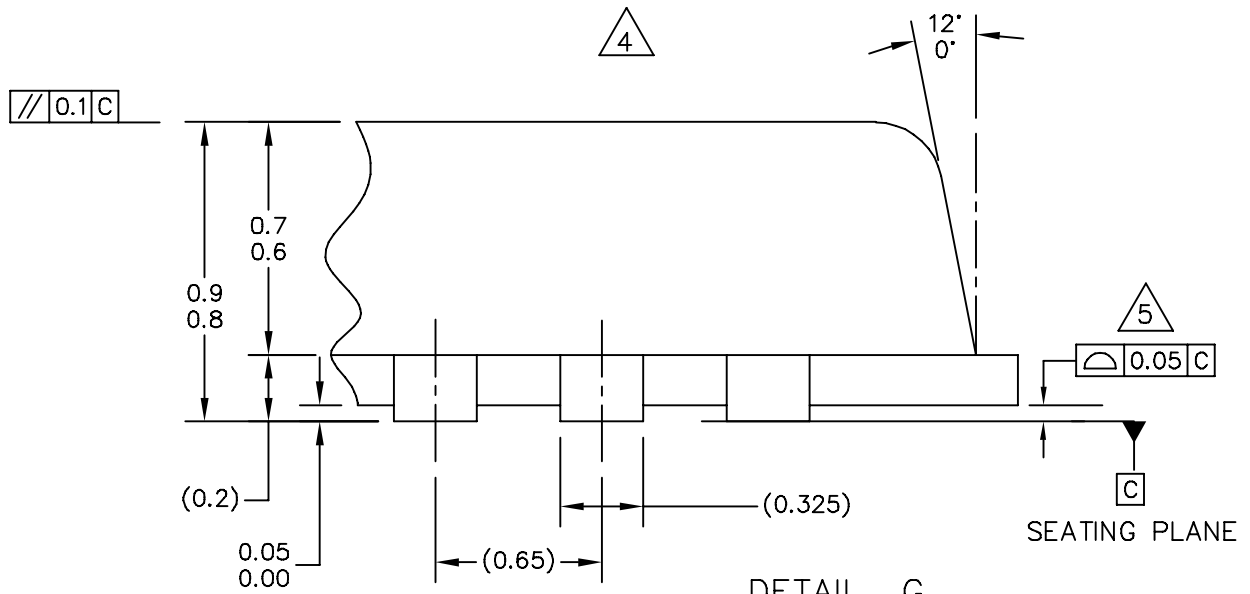

DETAIL G
VIEW ROTATED 90° CW

© FREESCALE SEMICONDUCTOR, INC. ALL RIGHTS RESERVED.	MECHANICAL OUTLINE	PRINT VERSION NOT TO SCALE	
TITLE: THERMALLY ENHANCED QUAD FLAT NON-LEADED PACKAGE (QFN) 16 TERMINAL, 0.65 PITCH (4 X 4 X 0.9)	DOCUMENT NO: 98ASA10761D	REV: 0	
	CASE NUMBER: 1898-01	08 SEP 2006	
	STANDARD: NON-JEDEC		

NOTES:

1. ALL DIMENSIONS ARE IN MILLIMETERS.
2. DIMENSIONING AND TOLERANCING PER ASME Y14.5M-1994.
3. THE COMPLETE JEDEC DESIGNATOR FOR THIS PACKAGE IS: HF-PQFN.
4. DIMENSIONS OF OPTIONAL FEATURES ARE FOR REFERENCE ONLY.
5. COPLANARITY APPLIES TO LEADS, CORNER LEADS, AND DIE ATTACH PAD.
6. MIN METAL GAP SHOULD BE 0.25MM.

© FREESCALE SEMICONDUCTOR, INC. ALL RIGHTS RESERVED.	MECHANICAL OUTLINE	PRINT VERSION NOT TO SCALE	
TITLE: THERMALLY ENHANCED QUAD FLAT NON-LEADED PACKAGE (QFN) 16 TERMINAL, 0.65 PITCH (4 X 4 X 0.9)	DOCUMENT NO: 98ASA10761D	REV: 0	
	CASE NUMBER: 1898-01	08 SEP 2006	
	STANDARD: NON-JEDEC		

PRODUCT DOCUMENTATION

Refer to the following documents to aid your design process.

Application Notes

- AN1955: Thermal Measurement Methodology of RF Power Amplifiers
- AN3100: General Purpose Amplifier Biasing

REVISION HISTORY

The following table summarizes revisions to this document.

Revision	Date	Description
0	Jan. 2008	<ul style="list-style-type: none">• Initial Release of Data Sheet
1	Mar. 2008	<ul style="list-style-type: none">• Corrected Table 7. Moisture Sensitivity Level Rating from 3 to 1, p. 3• Corrected S-Parameter table frequency column label to read "MHz" versus "GHz", p. 17, 18
2	Mar. 2008	<ul style="list-style-type: none">• Corrected Tape and Reel information from 330 mm to 12 mm, p. 1• Corrected Figs. 24, 35, Single-Carrier W-CDMA Adjacent Channel Power Ratio versus Output Power y-axis (ACPR) unit of measure to dBc, p. 12, 16

How to Reach Us:

Home Page:

www.freescale.com

Web Support:

<http://www.freescale.com/support>

USA/Europe or Locations Not Listed:

Freescale Semiconductor, Inc.
Technical Information Center, EL516
2100 East Elliot Road
Tempe, Arizona 85284
+1-800-521-6274 or +1-480-768-2130
www.freescale.com/support

Europe, Middle East, and Africa:

Freescale Halbleiter Deutschland GmbH
Technical Information Center
Schatzbogen 7
81829 Muenchen, Germany
+44 1296 380 456 (English)
+46 8 52200080 (English)
+49 89 92103 559 (German)
+33 1 69 35 48 48 (French)
www.freescale.com/support

Japan:

Freescale Semiconductor Japan Ltd.
Headquarters
ARCO Tower 15F
1-8-1, Shimo-Meguro, Meguro-ku,
Tokyo 153-0064
Japan
0120 191014 or +81 3 5437 9125
support.japan@freescale.com

Asia/Pacific:

Freescale Semiconductor Hong Kong Ltd.
Technical Information Center
2 Dai King Street
Tai Po Industrial Estate
Tai Po, N.T., Hong Kong
+800 2666 8080
support.asia@freescale.com

For Literature Requests Only:

Freescale Semiconductor Literature Distribution Center
P.O. Box 5405
Denver, Colorado 80217
1-800-441-2447 or 303-675-2140
Fax: 303-675-2150
LDCForFreescaleSemiconductor@hibbertgroup.com

Information in this document is provided solely to enable system and software implementers to use Freescale Semiconductor products. There are no express or implied copyright licenses granted hereunder to design or fabricate any integrated circuits or integrated circuits based on the information in this document.

Freescale Semiconductor reserves the right to make changes without further notice to any products herein. Freescale Semiconductor makes no warranty, representation or guarantee regarding the suitability of its products for any particular purpose, nor does Freescale Semiconductor assume any liability arising out of the application or use of any product or circuit, and specifically disclaims any and all liability, including without limitation consequential or incidental damages. "Typical" parameters that may be provided in Freescale Semiconductor data sheets and/or specifications can and do vary in different applications and actual performance may vary over time. All operating parameters, including "Typicals", must be validated for each customer application by customer's technical experts. Freescale Semiconductor does not convey any license under its patent rights nor the rights of others. Freescale Semiconductor products are not designed, intended, or authorized for use as components in systems intended for surgical implant into the body, or other applications intended to support or sustain life, or for any other application in which the failure of the Freescale Semiconductor product could create a situation where personal injury or death may occur. Should Buyer purchase or use Freescale Semiconductor products for any such unintended or unauthorized application, Buyer shall indemnify and hold Freescale Semiconductor and its officers, employees, subsidiaries, affiliates, and distributors harmless against all claims, costs, damages, and expenses, and reasonable attorney fees arising out of, directly or indirectly, any claim of personal injury or death associated with such unintended or unauthorized use, even if such claim alleges that Freescale Semiconductor was negligent regarding the design or manufacture of the part.

Freescale™ and the Freescale logo are trademarks of Freescale Semiconductor, Inc. All other product or service names are the property of their respective owners.
© Freescale Semiconductor, Inc. 2008. All rights reserved.

