

# Miniature Push-Pull Circular Connectors

## HR25A Series

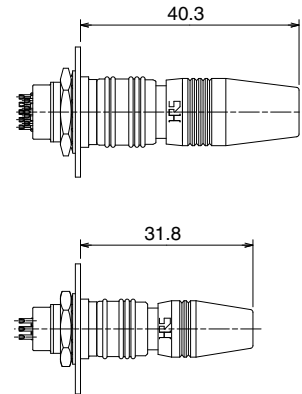

### Mated dimensions



### ■ Features

#### 1. Small size – high density

Outer diameters - plugs (max) : 11mm : 4, 6 and 8 positions  
13mm : 12, 16 and 20 positions

#### 2. Simple push-in/ pull-out mating / un-mating

Polarized for correct insertion by a straight push-in movement.  
Built-in lock release mechanism securely locks mated connectors while allowing quick disconnection by simply pulling on the plug release collar.

#### 3. Several mounting number of positions, styles and terminations

Number of positions : 4, 6, 8, 12, 16 and 20  
Connector : Plug, jack, receptacle  
Termination : Solder, crimp or PCB mounting type only for receptacle  
Choice of socket or pin contacts for plugs and receptacles.

#### 4. Metal shells

Secure lock between the metal shells provides excellent ground connection for the applications requiring EMI protection.

#### 5. RoHS compliant

All materials used in are compliant with RoHS regulations.

### ■ Diagrams of Connectors in Combination

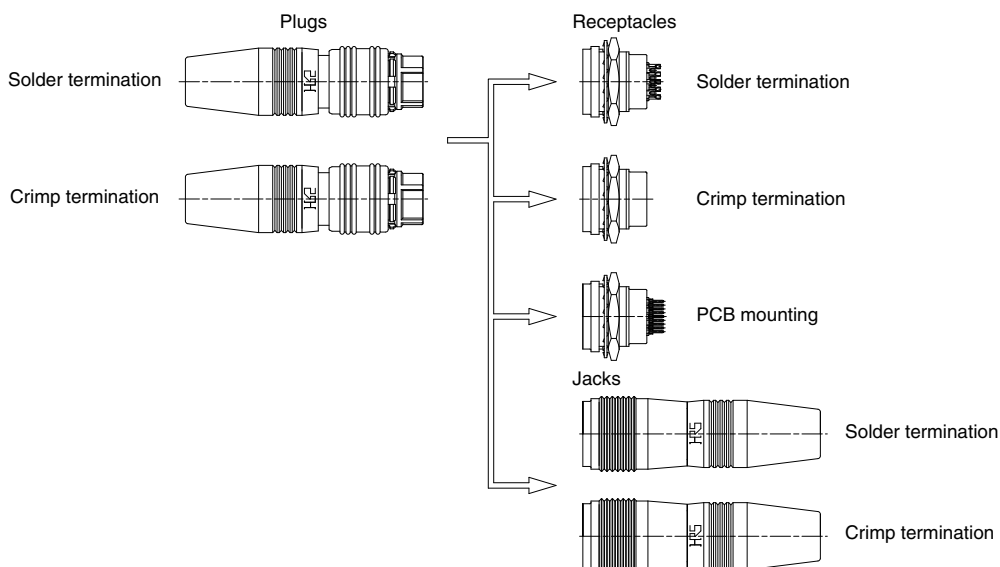

## ■ Specifications

| Ratings                  | Current rating   | 1A             | Operating temperature range   | -25°C to +85°C |
|--------------------------|--|----------------|---|----------------|
|                          | Voltage rating   | 30V AC, 42V DC | Storage temperature range   | -10°C to +60°C |
| Item                     | Specification  |                | Conditions  |                |
| 1. Insulation resistance | 1,000MΩ min.   |                | 100V DC   |                |
| 2. Withstanding voltage  | No flashover or insulation breakdown   |                | 100V AC / 1 minute (test voltage)   |                |
| 3. Contact resistance    | 30mΩ max.  |                | 1A DC   |                |
| 4. Durability            | Contact resistance : 50mΩ max.   |                | No damage, cracks or parts dislocation 1,000 cycles   |                |
| 5. Vibration             | No electrical discontinuity of 10μs or longer<br>No damage, cracks or parts dislocation.   |                | Frequency : 10 to 55Hz, single amplitude of 0.75mm<br>5 minute cycle, 10 cycles in each of the 3 axis                   |                |
| 6. Humidity              | Insulation resistance : 5MΩ min. (at high humidity)<br>Insulation resistance : 50MΩ min. (when dry)<br>No damage, cracks or parts dislocation. |                | 96 hours at 40°C, and humidity of 90 to 95%   |                |
| 7. Temperature cycle     | Insulation resistance : 1,000MΩ min.   |                | Temperature : -55°C → room temp. → +85°C → room temp.<br>Time : 30min. → 2 to 3 min. → 30min. → 2 to 3 min.<br>5 cycles |                |

## ■ Materials / Finish

| Item         | Material      | Finish   | Remarks       |
|--------------|---------------|--|---------------|
| Plug<br>Jack | Outer shell   | Zinc alloy                                       | Nickel plated |
|              | Insulator     | PPS  | UL94V-0       |
|              | Gasket, boots | Ethylene propylene rubber,<br>Chloroprene rubber |               |
|              | Contacts      | Phosphor bronze                                  | Gold plated   |
| Receptacle   | Outer shell   | Zinc alloy                                       | Nickel plated |
|              | Insulator     | PPS  | UL94V-0       |
|              | Contacts      | Phosphor bronze                                  | Gold plated   |

## ■ Product Number Structure

Refer to the chart below when determining the product specifications from the product number.  
Please select from the product numbers listed in this catalog when placing orders.

**HR25A - 7 P - 6 S C (\*\*)**

①
② ③
④ ⑤ ⑥
⑦

|  |   |
|--|---|
| ① Model name : HR25A Series  | ⑤ Contact type : S : Female contacts<br>P : Male contacts   |
| ② Shell size : The shell size is the outer diameter of the mating end of the plug. | ⑥ Termination type : Blank : Solder<br>C : Crimp<br>A : DIP                                       |
| ③ Connector type : P : Plug<br>R : Receptacle<br>J : Jack                          | ⑦ Other specifications A two-digit character is added to indicate other specifications as needed. |
| ④ Number of contacts : 4, 6, 8, 12, 16, 20   |   |

**Plug**

● Solder termination (contacts inserted)

Shell size : 7

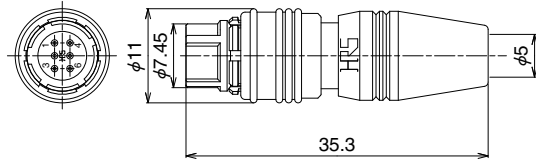

Shell size : 9

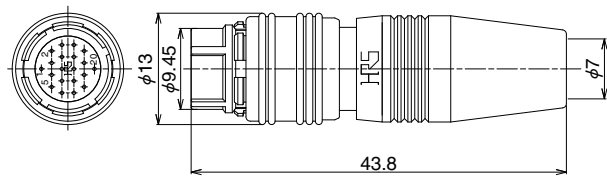

All dimensions : mm

| Shell size | No. of contacts | Male contact type |               | Female contact type |            |
|------------|-----------------|-------------------|---------------|---------------------|------------|
|            |                 | Part No.          | HRS No.       | Part No.            | HRS No.    |
| 7          | 4               | HR25A-7P-4P       | 125-0612-1    | HR25A-7P-4S         | 125-0613-4 |
|            | 6               | HR25A-7P-6P(31)   | 125-0602-8 31 | HR25A-7P-6S         | 125-0611-9 |
|            | 8               | HR25A-7P-8P       | 125-0609-7    | HR25A-7P-8S         | 125-0610-6 |
| 9          | 12              | HR25A-9P-12P      | 125-0607-1    | HR25A-9P-12S        | 125-0608-4 |
|            | 16              | HR25A-9P-16P      | 125-0605-6    | HR25A-9P-16S        | 125-0606-9 |
|            | 20              | HR25A-9P-20P      | 125-0600-2    | HR25A-9P-20S        | 125-0604-3 |

● Crimp termination (separate contacts required)

| Shell size | No. of contacts | Male contact type |            | Female contact type |            |
|------------|-----------------|-------------------|------------|---------------------|------------|
|            |                 | Part No.          | HRS No.    | Part No.            | HRS No.    |
| 9          | 12              | HR25A-9P-12PC     | 125-0652-6 | HR25A-9P-12SC       | 125-0653-9 |
|            | 16              | HR25A-9P-16PC     | 125-0650-0 | HR25A-9P-16SC       | 125-0651-3 |
|            | 20              | HR25A-9P-20PC     | 125-0648-9 | HR25A-9P-20SC       | 125-0649-1 |

## ■ Receptacle

### ● Solder termination (contacts inserted)

Shell size : 7

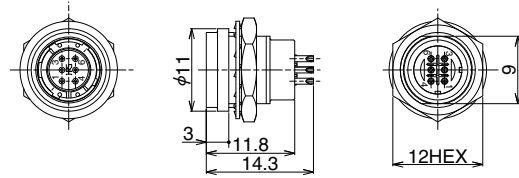

Shell size : 9

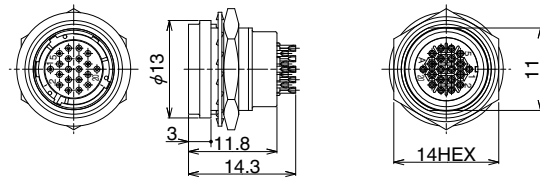

All dimensions : mm

| Shell size | No. of contacts | Male contact type |            | Female contact type |            |
|------------|-----------------|-------------------|------------|---------------------|------------|
|            |                 | Part No.          | HRS No.    | Part No.            | HRS No.    |
| 7          | 4               | HR25A-7R-4P       | 125-0623-8 | HR25A-7R-4S         | 125-0622-5 |
|            | 6               | HR25A-7R-6P       | 125-0621-2 | HR25A-7R-6S         | 125-0603-0 |
|            | 8               | HR25A-7R-8P       | 125-0620-0 | HR25A-7R-8S         | 125-0619-0 |
| 9          | 12              | HR25A-9R-12P      | 125-0618-8 | HR25A-9R-12S        | 125-0617-5 |
|            | 16              | HR25A-9R-16P      | 125-0616-2 | HR25A-9R-16S        | 125-0615-0 |
|            | 20              | HR25A-9R-20P      | 125-0614-7 | HR25A-9R-20S        | 125-0601-5 |

### ● Crimp termination (separate contacts required)

Male contact type  
HR25A-9R-20PC

Female contact type  
HR25A-9R-20SC

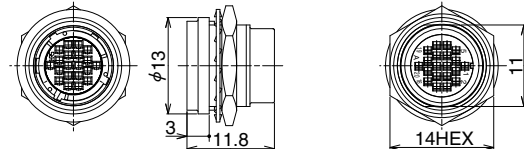
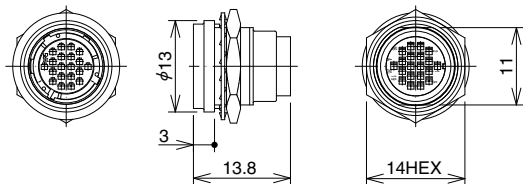

All dimensions : mm

| Shell size | No. of contacts | Male contact type |            | Female contact type |            |
|------------|-----------------|-------------------|------------|---------------------|------------|
|            |                 | Part No.          | HRS No.    | Part No.            | HRS No.    |
| 9          | 12              | HR25A-9R-12PC     | 125-0659-5 | HR25A-9R-12SC       | 125-0658-2 |
|            | 16              | HR25A-9R-16PC     | 125-0657-0 | HR25A-9R-16SC       | 125-0656-7 |
|            | 20              | HR25A-9R-20PC     | 125-0654-1 | HR25A-9R-20SC       | 125-0655-4 |

## ■ Receptacle

### ● Through hole (for PC board mounting)

Shell size : 7  
HR25A-7R-6SA

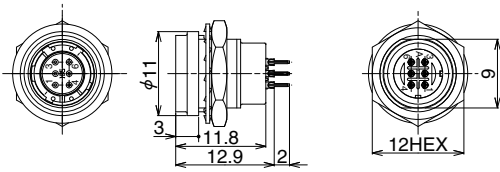

Shell size : 9  
HR25A-9R-20SA

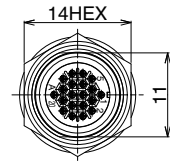
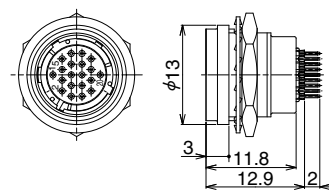

All dimensions : mm

| Shell size | No. of contacts | Male contact type |            | Female contact type |            |
|------------|-----------------|-------------------|------------|---------------------|------------|
|            |                 | Part No.          | HRS No.    | Part No.            | HRS No.    |
| 7          | 4               | HR25A-7R-4PA      | 125-0647-6 | HR25A-7R-4SA        | 125-0646-3 |
|            | 6               | HR25A-7R-6PA      | 125-0645-0 | HR25A-7R-6SA        | 125-0644-8 |
|            | 8               | HR25A-7R-8PA      | 125-0643-5 | HR25A-7R-8SA        | 125-0642-2 |
| 9          | 12              | HR25A-9R-12PA     | 125-0641-0 | HR25A-9R-12SA       | 125-0640-7 |
|            | 16              | HR25A-9R-16PA     | 125-0639-8 | HR25A-9R-16SA       | 125-0638-5 |
|            | 20              | HR25A-9R-20PA     | 125-0637-2 | HR25A-9R-20SA       | 125-0636-0 |

## ■ Jack

### ● Solder termination (contact inserted)

Shell size : 7  
HR25A-7J-6S

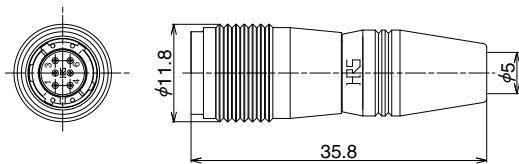

Shell size : 9  
HR25A-9J-20S

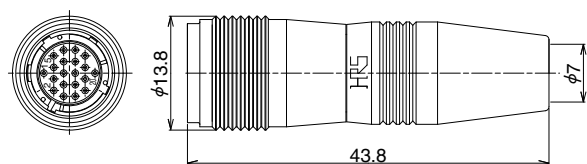

All dimensions : mm

| Shell size | No. of contacts | Male contact type |            | Female contact type |            |
|------------|-----------------|-------------------|------------|---------------------|------------|
|            |                 | Part No.          | HRS No.    | Part No.            | HRS No.    |
| 7          | 4               | HR25A-7J-4P       | 125-0635-7 | HR25A-7J-4S         | 125-0634-4 |
|            | 6               | HR25A-7J-6P       | 125-0633-1 | HR25A-7J-6S         | 125-0632-9 |
|            | 8               | HR25A-7J-8P       | 125-0631-6 | HR25A-7J-8S         | 125-0630-3 |
| 9          | 12              | HR25A-9J-12P      | 125-0629-4 | HR25A-9J-12S        | 125-0628-1 |
|            | 16              | HR25A-9J-16P      | 125-0627-9 | HR25A-9J-16S        | 125-0626-6 |
|            | 20              | HR25A-9J-20P      | 125-0625-3 | HR25A-9J-20S        | 125-0624-0 |

### ● Crimp termination (separate contacts required)

| Shell size | No. of contacts | Male contact type |            | Female contact type |            |
|------------|-----------------|-------------------|------------|---------------------|------------|
|            |                 | Part No.          | HRS No.    | Part No.            | HRS No.    |
| 9          | 12              | HR25A-9J-12PC     | 125-0665-8 | HR25A-9J-12SC       | 125-0664-5 |
|            | 16              | HR25A-9J-16PC     | 125-0663-2 | HR25A-9J-16SC       | 125-0662-0 |
|            | 20              | HR25A-9J-20PC     | 125-0661-7 | HR25A-9J-20SC       | 125-0660-4 |

◆ Crimp contact

Male contact

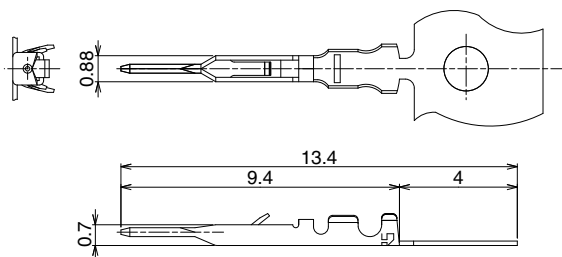

Female contact

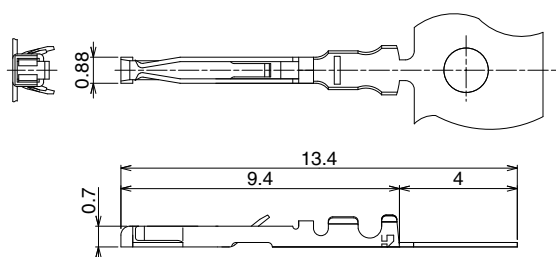

All dimensions : mm

| Type          | Part No.    | HRS No.    | Conductor size / construction | Type          | Part No.    | HRS No.    | Conductor size / construction |
|---------------|-------------|------------|-------------------------------|---------------|-------------|------------|-------------------------------|
| Loose contact | HR25-PC-111 | 125-0419-1 | 30 AWG                        | Loose contact | HR25-SC-111 | 125-0421-3 | 30 AWG                        |
| Reel contact  | HR25-PC-211 | 125-0420-0 |                               | Reel contact  | HR25-SC-211 | 125-0422-6 |                               |

Note 1 : Wire jacket outer diameter 0.71mm max.

Note 2 : Loose piece contacts are packaged 100 pcs/pack. Reel contacts are packaged 10,000 pcs/reel.

◆ Applicable tools

| Type                          | Part No.      | HRS No.    | Used on                    |
|-------------------------------|---------------|------------|----------------------------|
| Manual contact crimping tool  | HR25-TA3032HC | 150-0207-3 | HR25-PC-111 or HR25-SC-111 |
| Automatic crimping machine    | CM-105C       | 901-0001-0 | —                          |
| Applicator                    | AP105-HR25-1  | 901-2040-6 | HR25-PC-211 or HR25-SC-211 |
| Cable clamp crimp tool        | HR10A-TC-02   | 150-0041-2 | —                          |
| Solder termination fixture    | HR25A-7P-T02  | 150-0243-7 | HR25A-7P For tightening    |
|                               | HR25-7P-T01   | 150-0085-8 | HR25A-7P For wiring        |
| Plug shell tightening fixture | HR25A-9P-T02  | 150-0242-4 | HR25A-9P For tightening    |
|                               | HR25-9P-T01   | 150-0086-0 | HR25A-9P For wiring        |
| Contact extraction tool       | HR25-TP       | 150-0091-0 | —                          |

◆ Panel cutouts

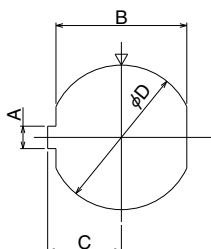

All dimensions : mm

| Dimensions                 | HR25A-7R                               | HR25A-9R                                |
|----------------------------|--|---|
| A                          | 1.55 <sup>+0.05</sup> <sub>0</sub>     |   |
| B                          | 9.05 <sup>+0.03</sup> <sub>-0.02</sub> | 11.05 <sup>+0.03</sup> <sub>-0.02</sub> |
| C                          | 5.1 <sup>+0.1</sup> <sub>0</sub>       | 6.1 <sup>+0.1</sup> <sub>0</sub>        |
| D                          | 10 <sup>+0.05</sup> <sub>0</sub>       | 12 <sup>+0.05</sup> <sub>0</sub>        |
| Applicable panel thickness | 0.7 to 2                               |   |

Note 1 : The receptacle panel cutout is a view from the mating side.

◆ PCB mounting pattern (for through-hole PC board mounting)

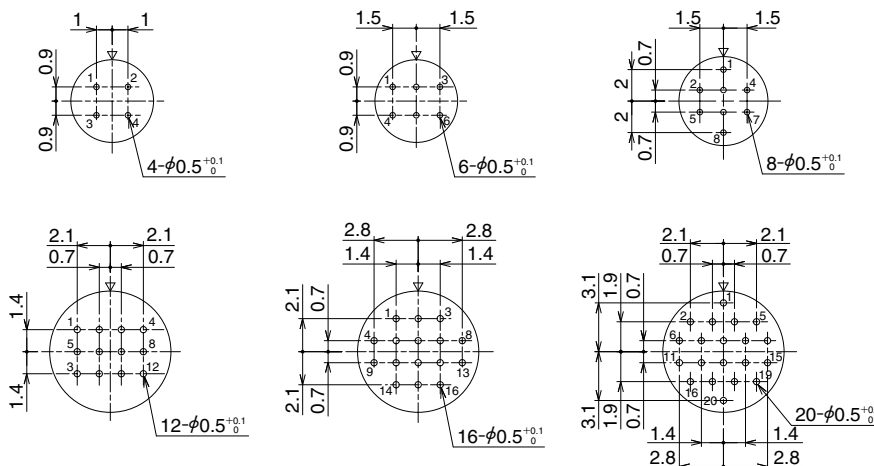

Note 1 : The above diagrams are viewed from the engagement side of the socket insert (i.e., the wiring side of the pin insert).

Note 2 : The ▽ mark of the above diagrams indicates the engagement guide key position.

Note 3 : Plated through hole location and diameter tolerance: ±0.05.

## ◆ Contact Position Arrangement

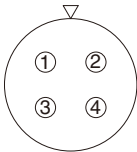
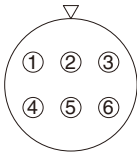
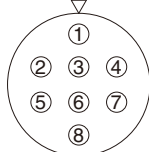
| Shell size               | Size 7  |  |   |
|--------------------------|---|--|---|
| Contact configuration    |  |  |  |
| No. of contacts          | 4   | 6  | 8   |
| Withstand voltage        | 100V AC for 1 minute  |  |   |
| Current capacity         | 1A  |  |   |
| Insulation resistance    | 1,000MΩ or greater  |  |   |
| Contact resistance       | 30mΩ  |  |   |
| Solderpot inner diameter | 0.5mm dia.  |  |   |

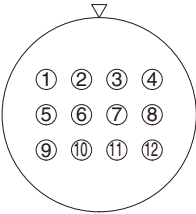
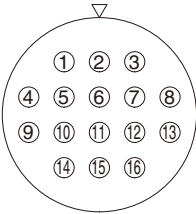
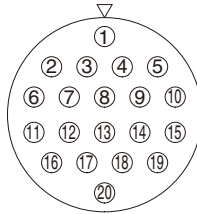
| Shell size               | Size 9   |   |  |
|--------------------------|--|---|--|
| Contact configuration    |  |  |  |
| No. of contacts          | 12   | 16  | 20   |
| Withstand voltage        | 100V AC for 1 minute   |   |  |
| Current capacity         | 1A   |   |  |
| Insulation resistance    | 1,000MΩ or greater   |   |  |
| Contact resistance       | 30mΩ   |   |  |
| Solderpot inner diameter | 0.5mm dia.   |   |  |

Note 1 : The above diagrams are viewed from the engagement side of the socket insert (i.e., the wiring side of the pin insert).

Note 2 : The ▽ mark of the above diagrams indicates the engagement guide key position.

Note 3 : The withstand voltage indicates the test voltage value. For regular use the voltage used should be less than 30V AC or 42V DC.

Note 4 : The current capacity of the crimp terminals indicates the value when using wire of 30 AWG.

Note 5 : The insulation resistance indicates a value when measured at 100V DC.

## ◆ Precautions

1. Switch off the power of the circuit before disconnecting or plugging-in the connectors.
2. Use connectors with socket contacts at the power side of the circuit.
3. Make sure that the coupling is in completely cocked position.
4. Cable clamping, cable rotation, and other forces may vary with the cable construction.  
Please make sure that your cable is suitable for use with these connectors before usage and production.
5. For plug and jack, screw part of shell has an anti-looseness coating (Mec process), but the adhesive function is impaired when they are reused. Therefore, apply Loctite 263 which is manufactured by Henkel Japan Ltd., Tokyo to the screw part during reassembly in order to prevent looseness.

# MEMO:

A series of horizontal dashed lines for writing a memo.

---

**HIROSE ELECTRIC CO.,LTD.**

2-6-3,Nakagawa Chuoh,Tsuzuki-Ku,Yokohama-Shi 224-8540,JAPAN  
<https://www.hirose.com/>

---