



TAOGLAS®

Datasheet

Taoglas Invisible Antenna™

Part No:
TFX125.A

Description

TFX125.A – Multiband GNSS Invisible Antenna

Features:

Multiband GNSS
Transparent Polymer Antenna
Dimensions: 76mm*47mm
Connector: FAKRA Code C (M) Blue
RoHS & Reach Compliant



1.	Introduction	2
2.	Specification	3
3.	Antenna Characteristics	5
4.	Radiation Patterns	8
5.	Mechanical Drawing	14
6.	Packaging	15
<hr/>		
	Changelog	16

Taoglas makes no warranties based on the accuracy or completeness of the contents of this document and reserves the right to make changes to specifications and product descriptions at any time without notice. Taoglas reserves all rights to this document and the information contained herein. Reproduction, use or disclosure to third parties without express permission is strictly prohibited.



1. Introduction



The TFX125.A is a first of its kind, invisible antenna designed to cover multi GNSS bands. The TFX125.A has been expertly engineered by Taoglas with innovation in mind, the design is based on our excellent design history in pioneering flexible PCB antenna technology. TFX125.A is supplied with pre adhered adhesive for ease of installation and has an enclosed carrier terminated with a FAKRA connector.

The invisible flexible antennas are an alternative to standard Flexible PCB antennas where the user may want to install an antenna in a covert area or on a surface, they may want to keep visible. The performance of the antenna is based on the environment where it is placed, care should be taken to mount at least 20mm from metal components where possible.

Typical Applications Include:

- Automotive and Commercial Transportation
- EV Charging and Parking Bays
- Digital Signage and Display screens
- Point Of Sale Kiosks

The installation of the Taoglas Invisible Antenna™ series follows a similar installation method to flexible PCB antennas, as detailed in this [application note](#). Installing a transparent material may show obvious flaws/debris, take care to wipe the area clean before adhering the antenna. The flexible antenna can be disconnected from the body to make installation easier. Where support may be an issue, we would advise using a double-sided adhesive on the housing to ensure the housing body installation does not add any additional pull force to the antenna as this will affect the antennas performance and the adhesive's performance. The feed is not designed to be load bearing and loads of over 0.5Kg can break or damage the feed resulting in the antenna disconnecting.

The TFX125.A is connected via a FAKRA Code C male connector for ease of installation. If a custom connector is required, please contact your regional Taoglas customer support team.

2. Specification

GNSS Frequency Bands					
GPS	L1 1575.42 MHz	L2 1227.6 MHz	L5 1176.45 MHz		
	■	■	■		
GLONASS	G1 1602 MHz	G2 1248 MHz	G3 1207 MHz		
	■	■	■		
Galileo	E1 1575.24 MHz	E5a 1176.45 MHz	E5b 1201.5 MHz	E6 1278.75 MHz	
	■	□	■	■	
BeiDou	B1C 1575.42 MHz	B1I 1561 MHz	B2a 1176.45 MHz	B2b 1207.14 MHz	B3 1268.52 MHz
	■	■	■	■	■
QZSS (Regional)	L1 1575.42 MHz	L2C 1227.6 MHz	L5 1176.45 MHz	L6 1278.75e6	
	■	■	■	■	
IRNSS (Regional)	L5 1176.45 MHz				
	■				
SBAS	L1/E1/B1 1575.42 MHz	L5/B2a/E5a 1176.45 MHz	G1 1602 MHz	G2 1248 MHz	G3 1207 MHz
	■	■	■	■	■

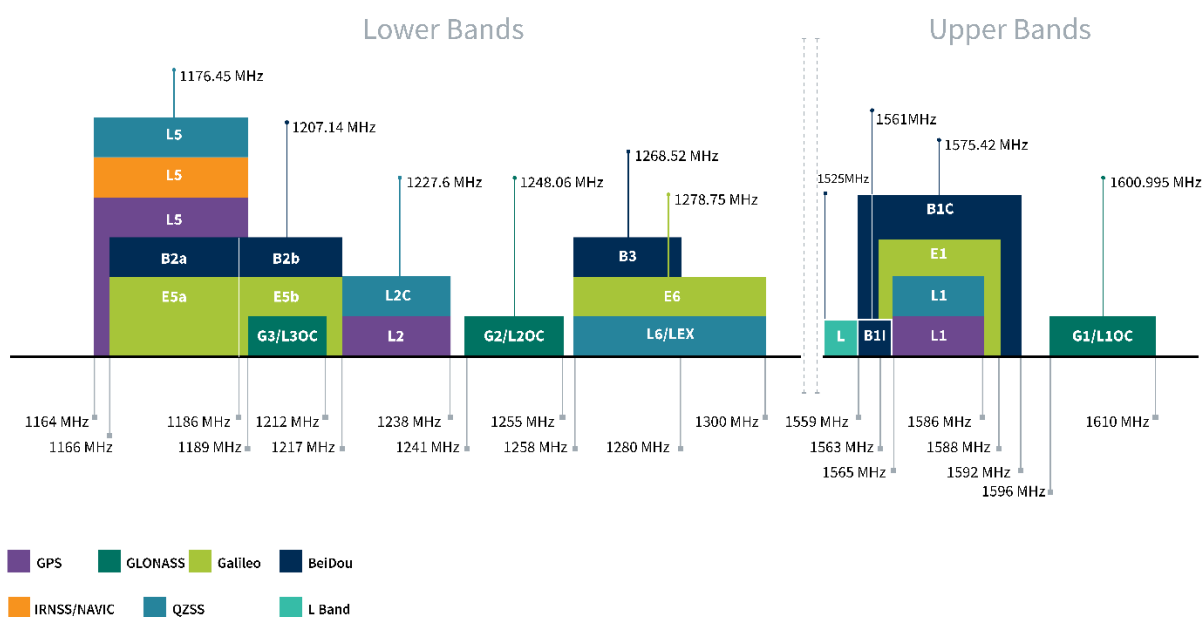

GNSS Electrical						
Frequency (MHz)	1176.45	1227.6	1278.75	1561	1575.42	1602
VSWR (max.)	6:1	3:1	4:1	2:1	2:1	2:1
Passive Antenna Efficiency (%) (Without cable loss)	27.45	32.36	36.32	48.88	49.29	49.78
Passive Antenna Gain at Zenith (dBic) (Without cable loss)	-5.67	-5.46	-4.71	-9.09	-9.09	-9.88
Polarization	Linear					
Impedance	50 Ω					

Mechanical	
Dimensions	81.6 x 176mm
Weight	5g
Material (Housing)	ABS/PC
Connector	Code C FAKRA (M) Blue

Environmental	
Operation Temperature	-40°C to 85°C
Storage Temperature	-40°C to 85°C

3. Antenna Characteristics

3.1 Return Loss

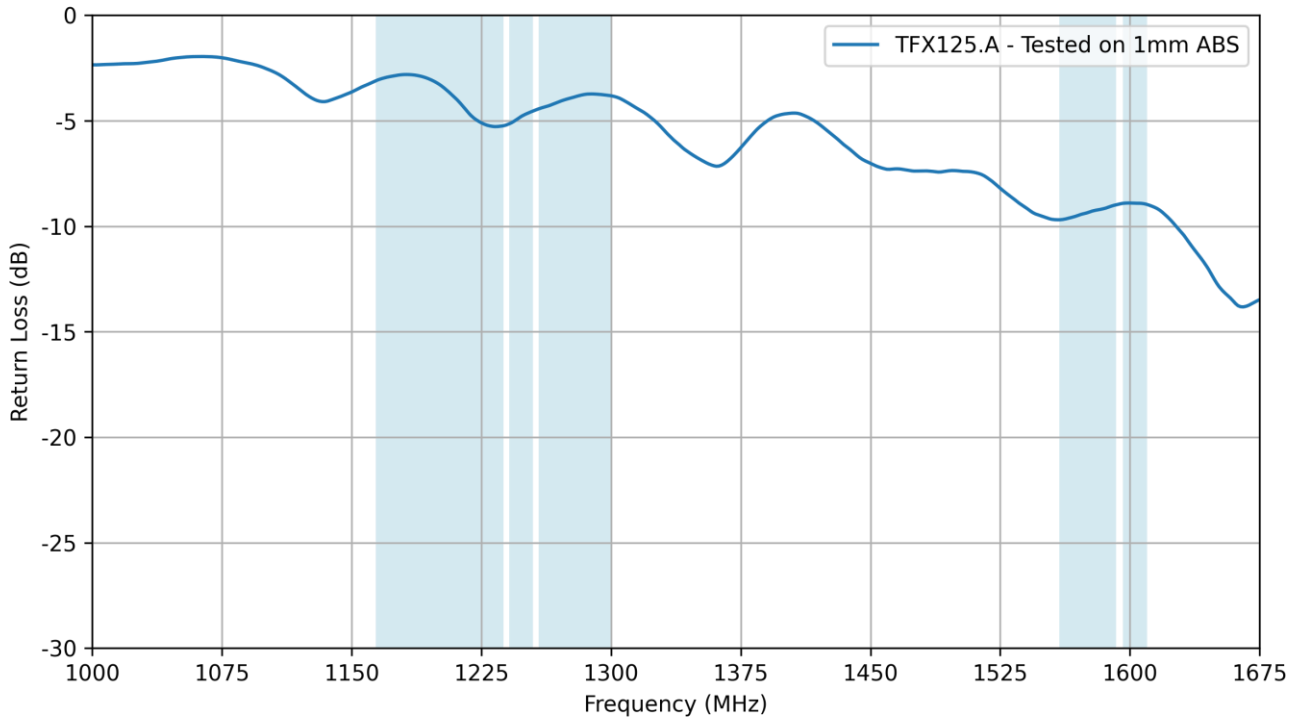

3.2 VSWR

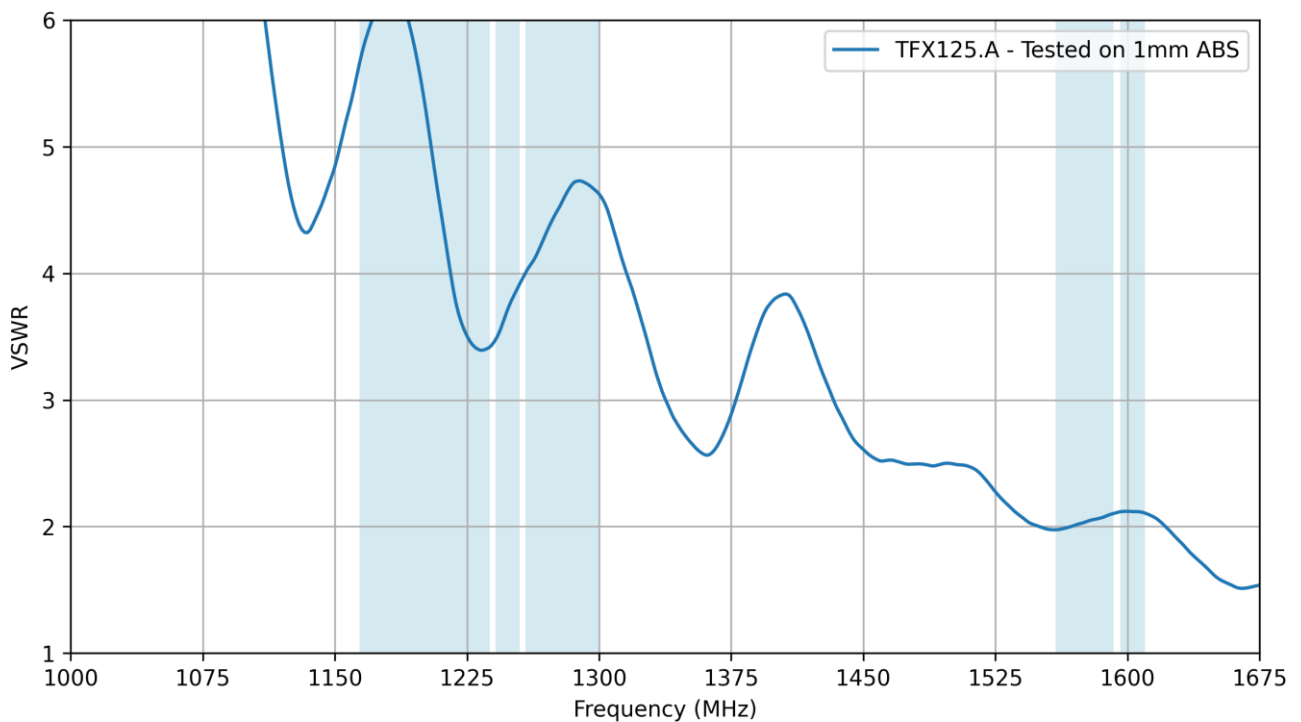

3.3 Efficiency

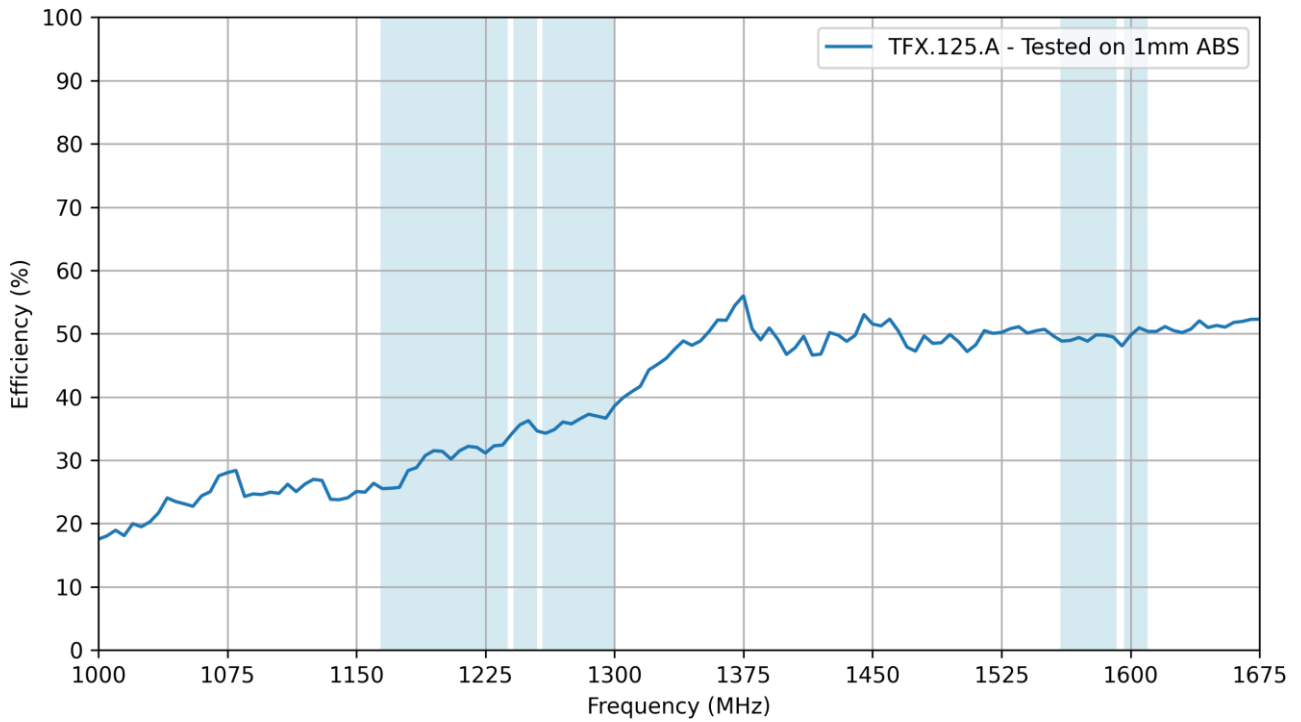

3.4 Average Gain

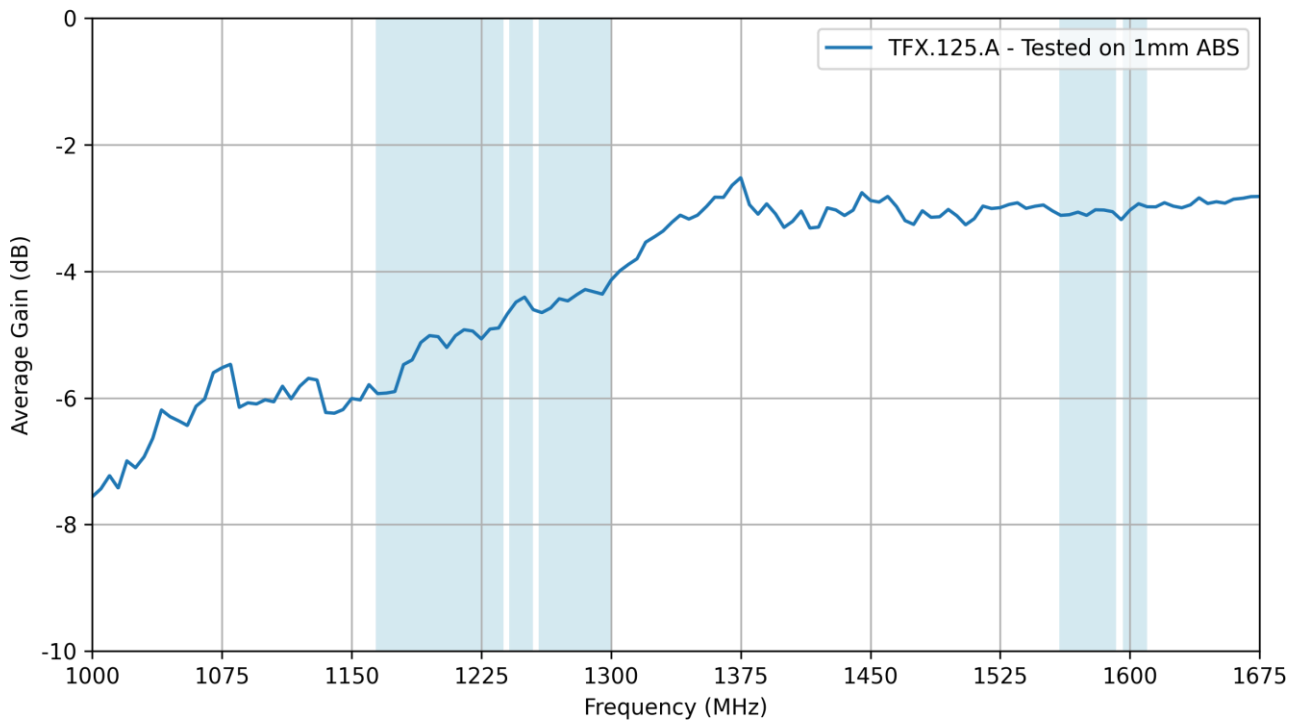

3.5 Peak Gain

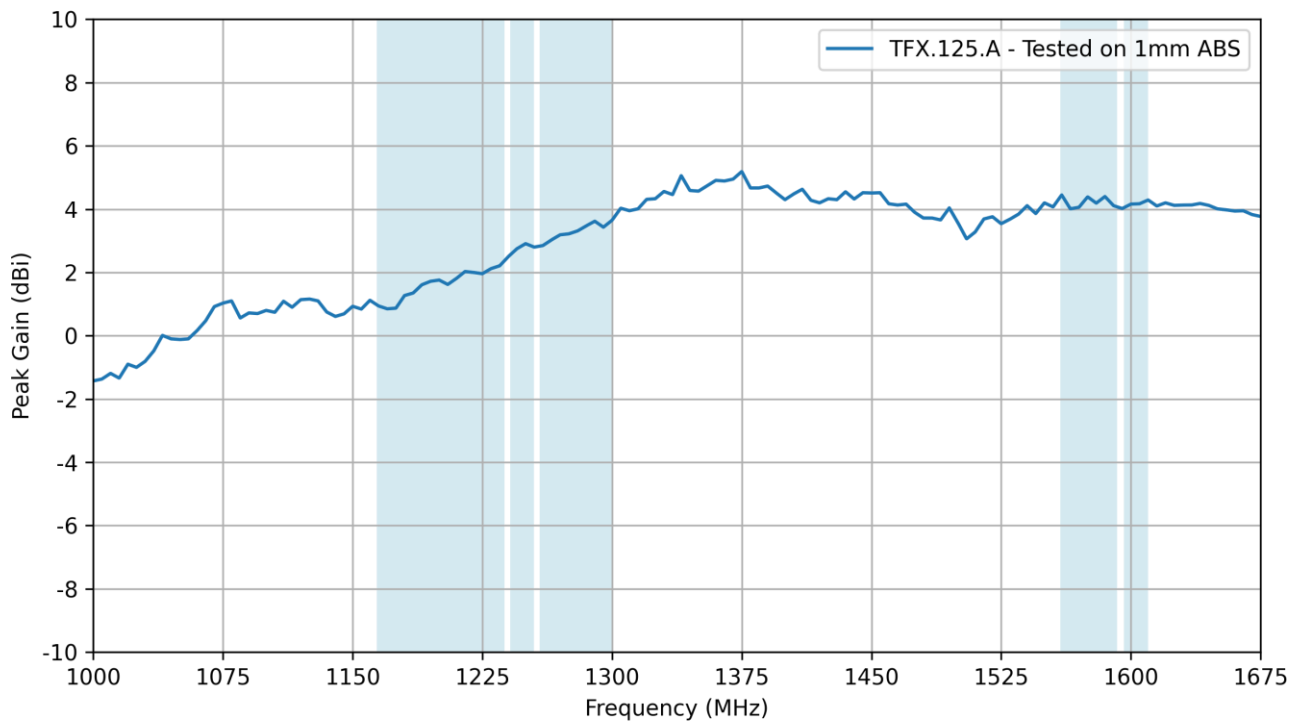

4. Radiation Patterns

4.1 Test Setup

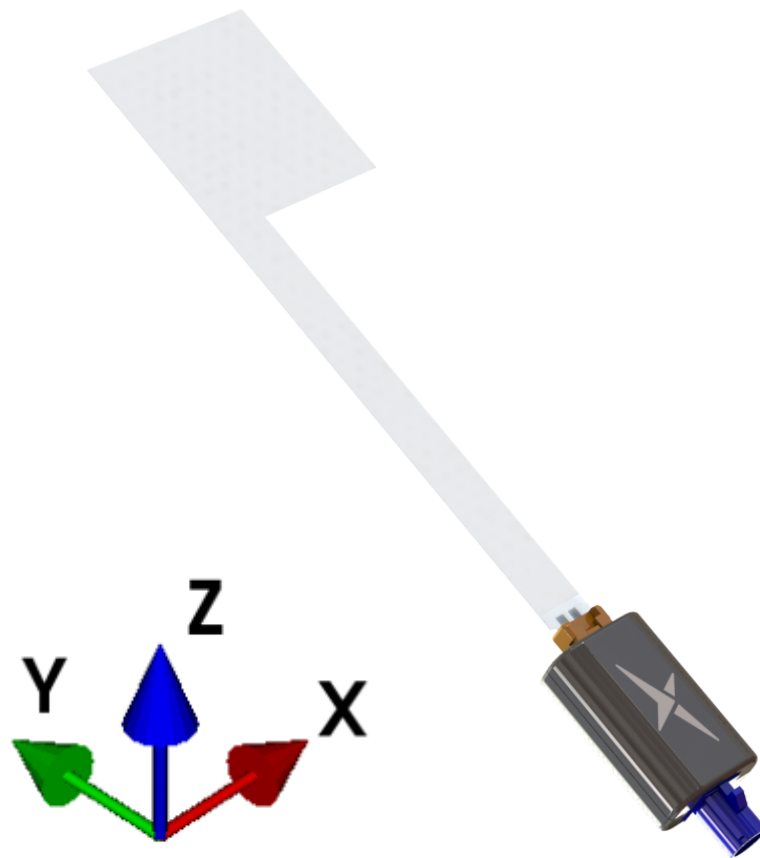
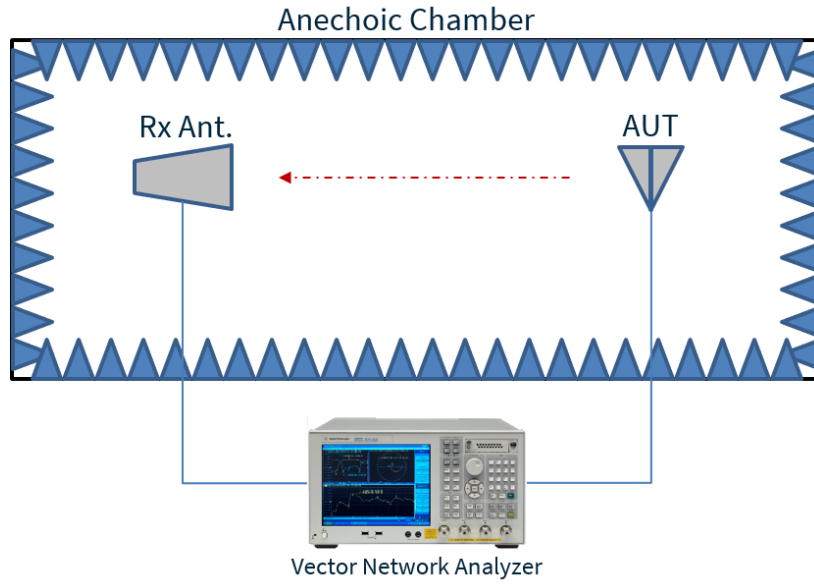

4.2 TFX.125.A - Tested on 1mm ABS Patterns at 1576 MHz

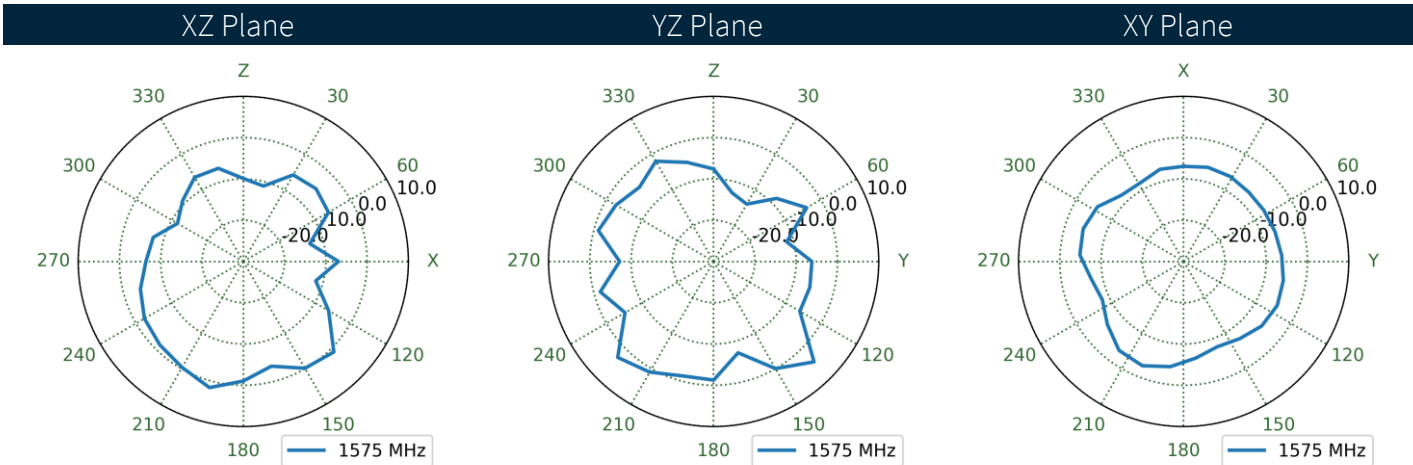
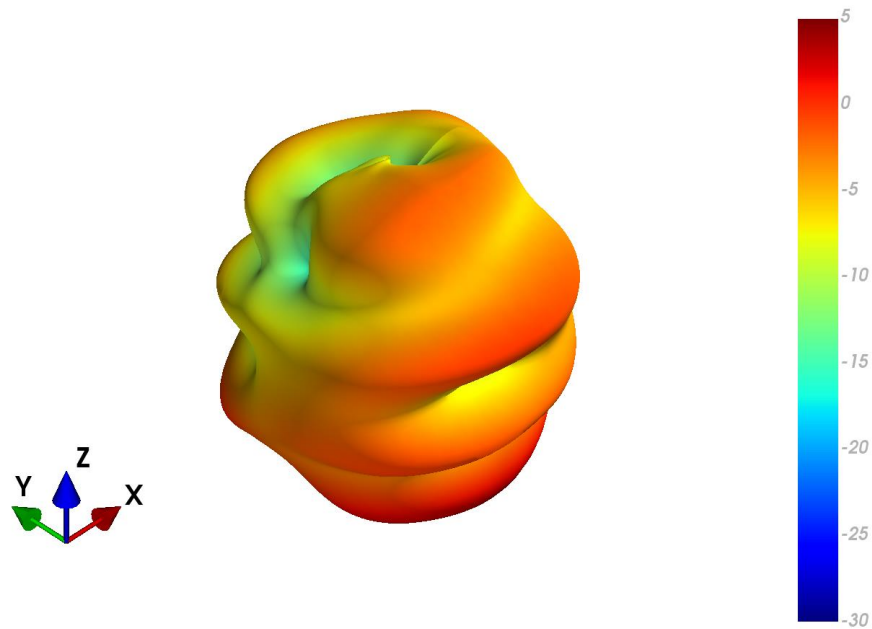

4.3 TFX.125.A - Tested on 1mm ABS Patterns at 1228 MHz

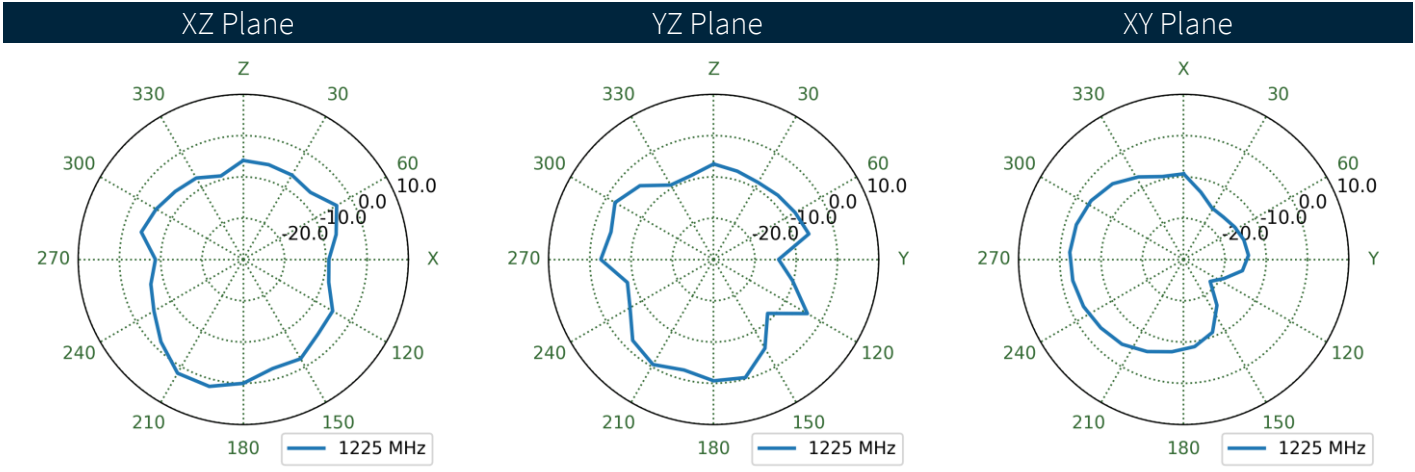
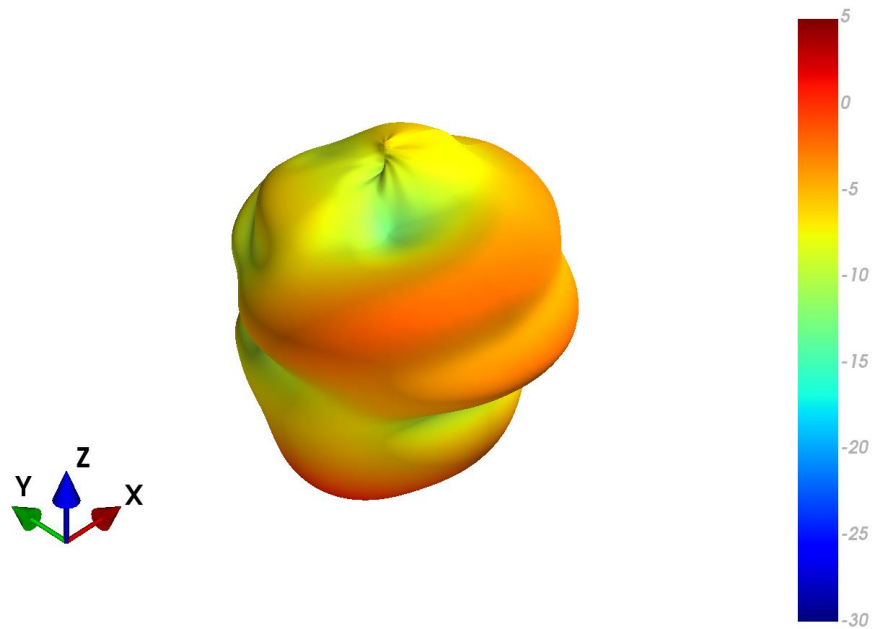

4.4 TFX.125.A - Tested on 1mm ABS Patterns at 1177 MHz

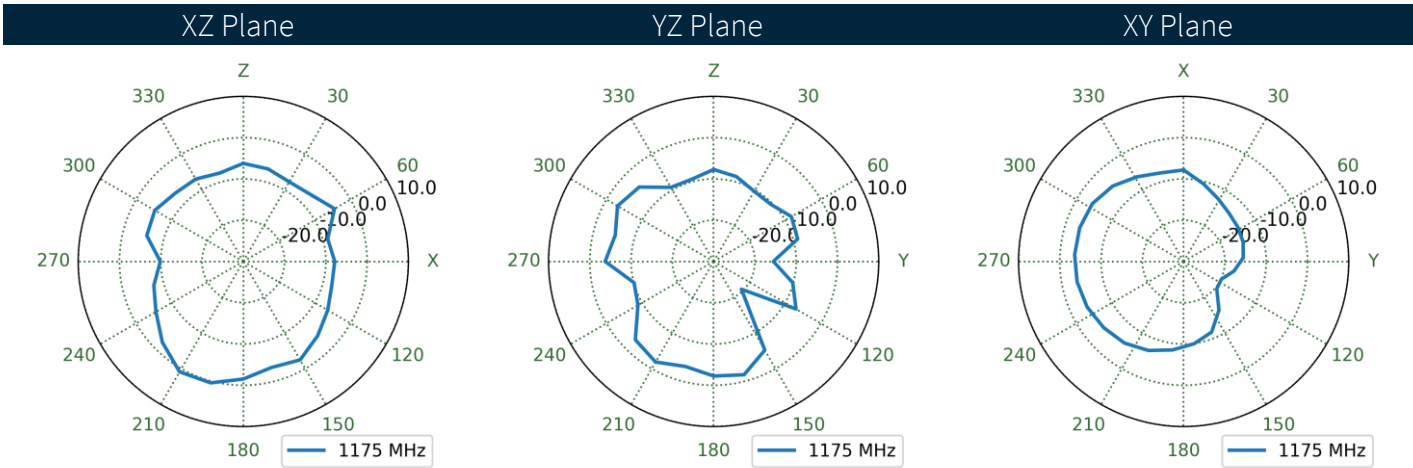
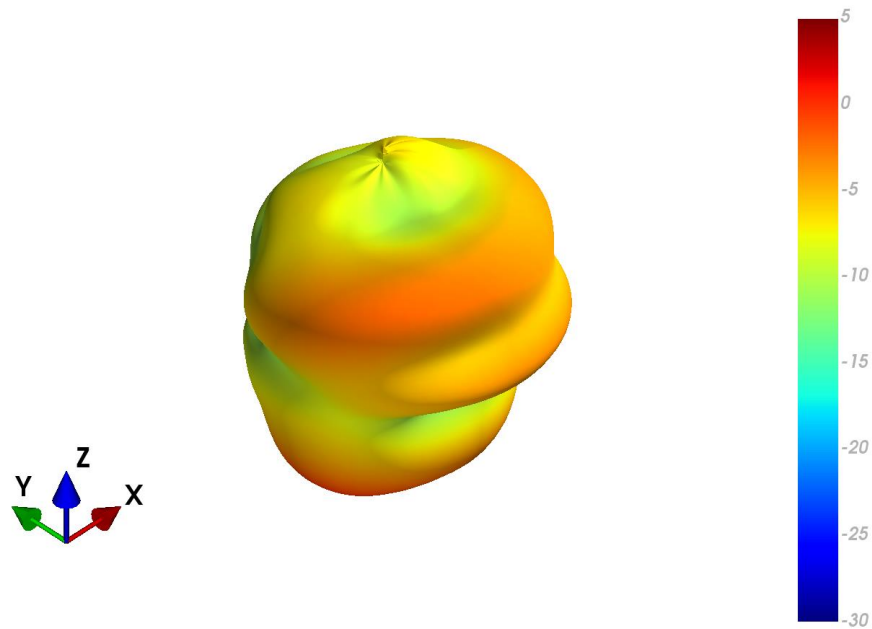

4.5 TFX.125.A - Tested on 1mm ABS Patterns at 1603 MHz

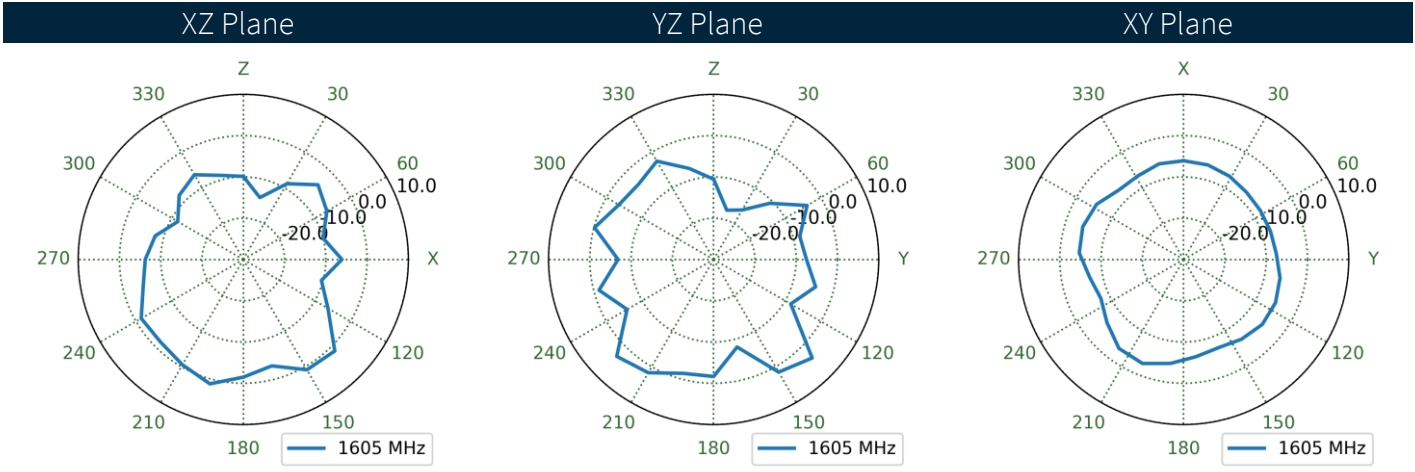
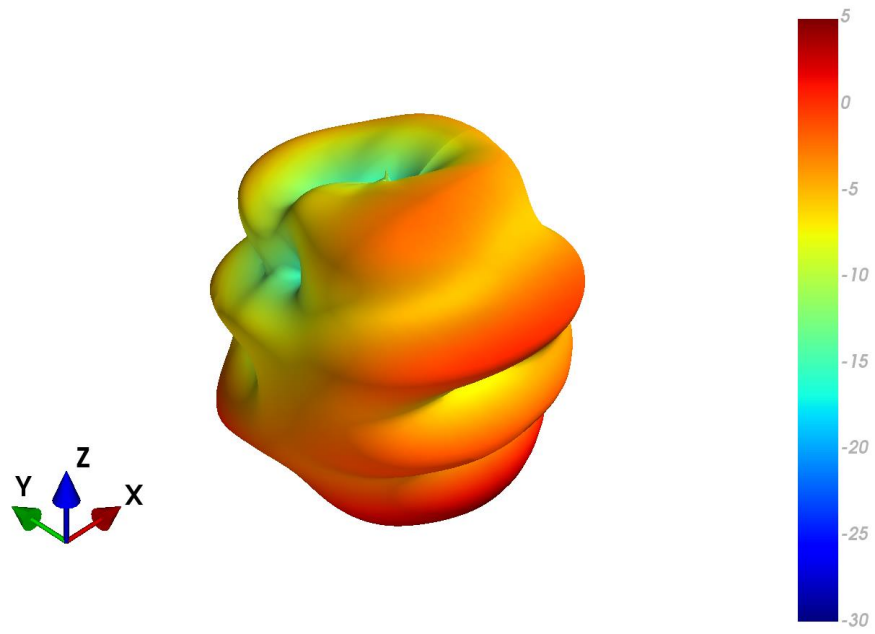

4.6 TFX.125.A - Tested on 1mm ABS Patterns at 1562 MHz

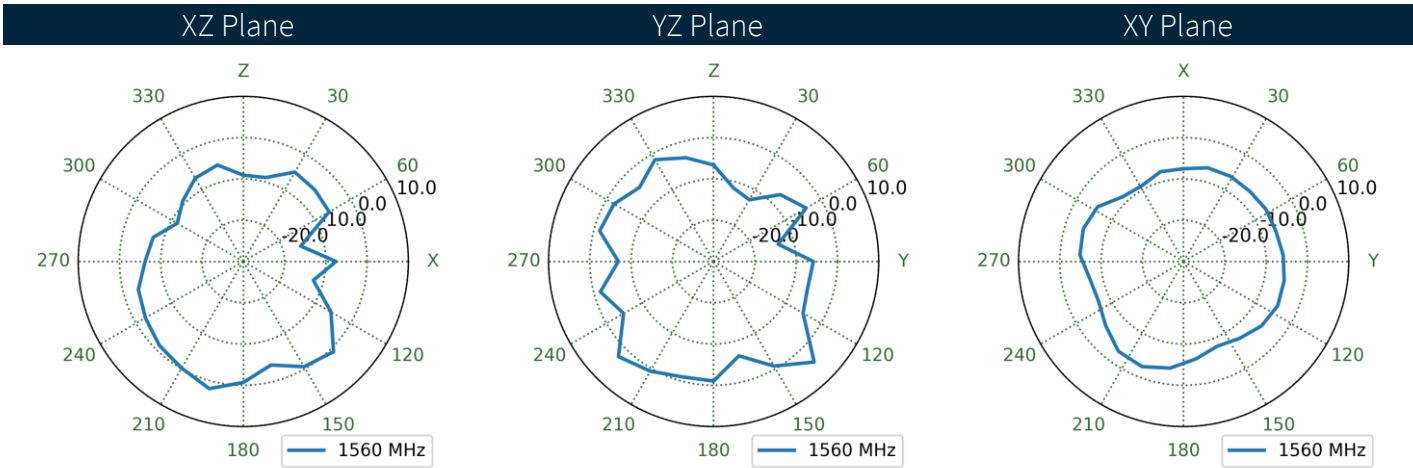
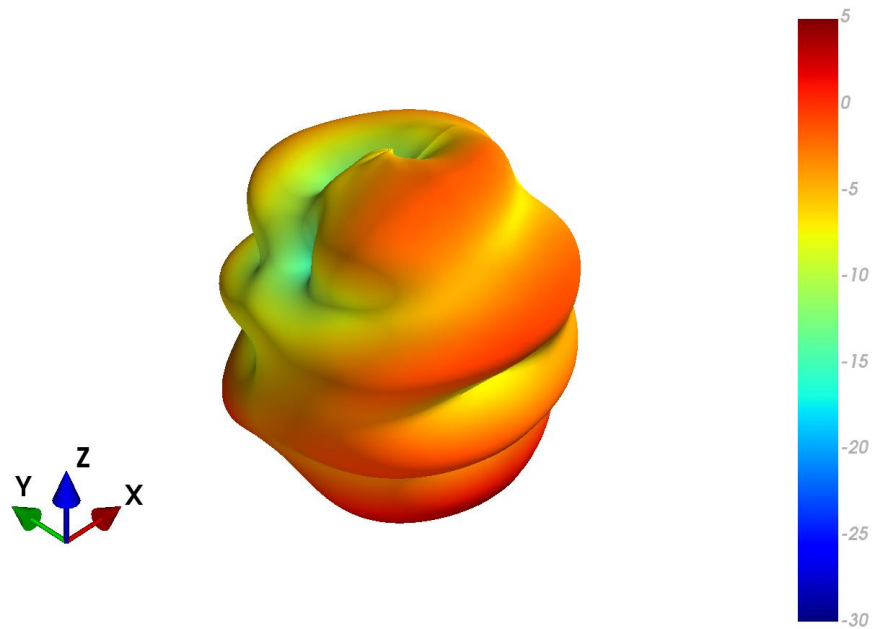

5. Mechanical Drawing

ISO NO.: EDW-22-8-0997
 STATE: RELEASE
 NOTES: 1.ALL MATERIAL MUST BE ROHS COMPLIANT.

REVISIONS				
REV.	DESCRIPTION	DATE	ENGINEER	APPROVED
D01	FIRST ISSUE	17OCT2022	SC	WL
D02	MODIFICATION TO SIZE AND SHAPE OF FLEX ANTENNA	02DEC2022	SC	WL

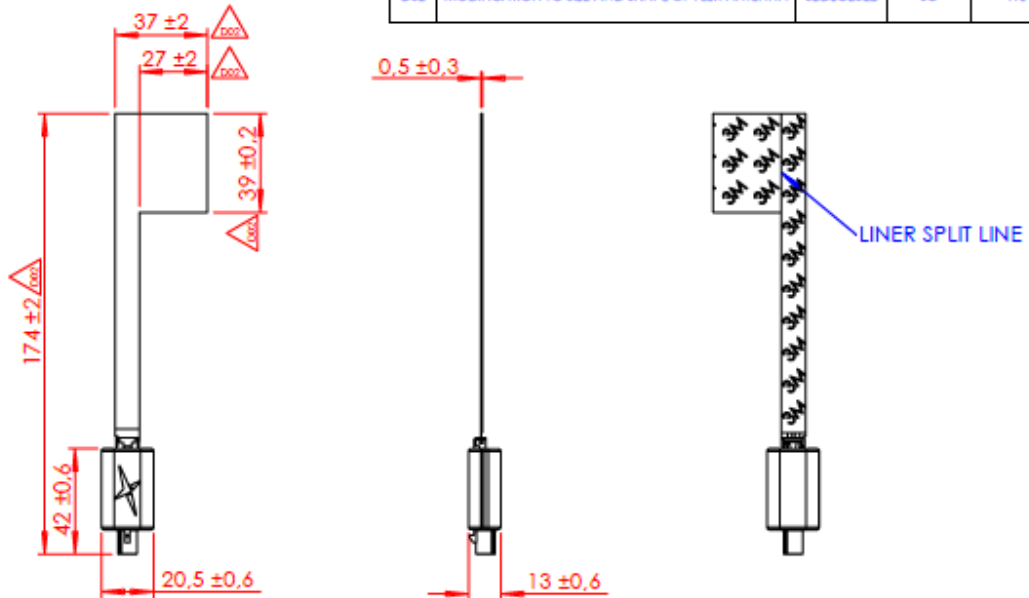

ITEM NO.	DESCRIPTION	MATERIAL	FINISH	QTY
1	TRANSPARENT FLEX GNSS ANTENNA	PET	CLEAR	1
2	FPC-to-BOARD CONNECTOR ADAPTOR 2 CONTACT	LCP	BLACK	1
3	ANTENNA PCB HOUSING	ABS/PC	BLACK	1
4	FAKRA CODE C MALE	NYLON/ZINC	BLUE	1
5	3M ADHESIVE + LINER	3M 8146	BROWN LINER	1

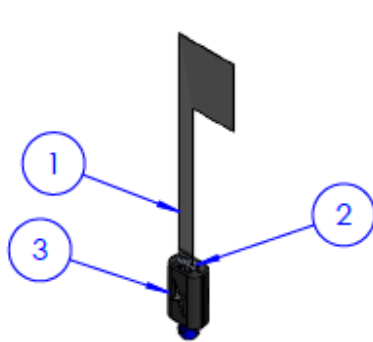

MODEL VIEW
SCALE 1:3

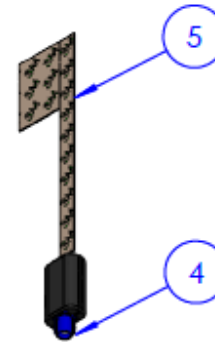

MODEL VIEW
SCALE 1:3

APPROVED BY: NW	 <small>OMEA Design Centre</small> This drawing and its inherent design concepts are property of Taoglas. Not to be copied or given to third parties without the written consent of Taoglas.
CHECK BY: WL	
DRAWN BY: SC	
DATE: 17OCT2022	
<small>UNLESS OTHERWISE SPECIFIED TOLERANCES ARE:</small> 3X: ±0.3 2X: ±0.2 1X: ±0.1 2022/08/23	TITLE: TRANSPARENT FLEX MULTIBAND GNSS ANTENNA w/CONVERTER AND FAKRA CODE C MALE
THIRD ANGLE PROJECTION	PART NO.: TFX125.A
UNIT: mm	SCALE: 2:5
PAGE: 1/1	REV: D02

6. Packaging

TBD

Changelog for the datasheet

SPE-22-8-164 – TFX125.A

Revision: A (Original First Release)	
Date:	2023-02-01
Notes:	Initial Release
Author:	Gary West

Previous Revisions



www.taoglas.com

