

Toggle Switches

Miniature-Sealed

multicomp PRO

**RoHS
Compliant**



Specifications

Material

Movable Contact : Copper Alloy, Silver Plated
 Terminals : Silver Plated with outer layer in gold plating

Electrical

Rating : 5 Amps with resistive load @ 125V AC or 28V DC
 2 Amps with resistive load @ 250V AC
 Contact Resistance : 10mΩ max. initial
 Insulation Resistance : 1000MΩ min.
 Dielectric withstanding Voltage : 1500V RMS @ sea level
 Electrical Life : 50,000 make and break cycles at full load

Temperature Rating

Operating temperature : -30°C to +85°C

Environmental

IP Class : IP67

Diagram

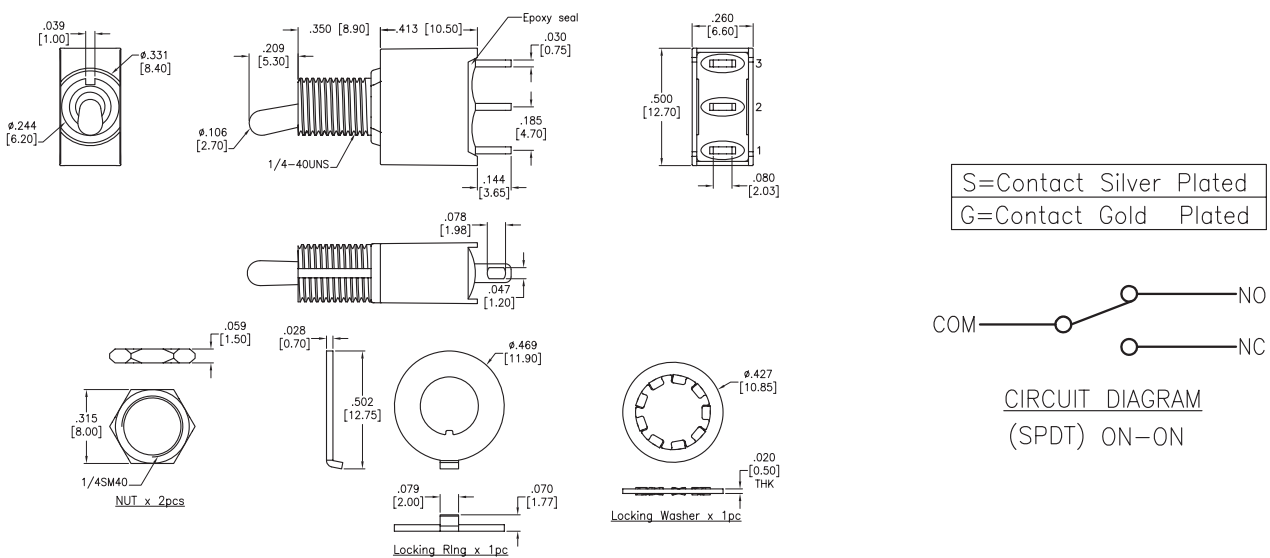

Dimensions : Millimetres

Part Number Table

Description	Part Number
Toggle Switch, SPDT, On-On, Solder Type	MP-T2-2B-A-T2-S-03

Important Notice : This data sheet and its contents (the "Information") belong to the members of the AVNET group of companies (the "Group") or are licensed to it. No licence is granted for the use of it other than for information purposes in connection with the products to which it relates. No licence of any intellectual property rights is granted. The Information is subject to change without notice and replaces all data sheets previously supplied. The Information supplied is believed to be accurate but the Group assumes no responsibility for its accuracy or completeness, any error in or omission from it or for any use made of it. Users of this data sheet should check for themselves the Information and the suitability of the products for their purpose and not make any assumptions based on information included or omitted. Liability for loss or damage resulting from any reliance on the Information or use of it (including liability resulting from negligence or where the Group was aware of the possibility of such loss or damage arising) is excluded. This will not operate to limit or restrict the Group's liability for death or personal injury resulting from its negligence. Multicomp Pro is the registered trademark of Premier Farnell Limited 2019.

Newark.com/multicomp-pro
 Farnell.com/multicomp-pro
 sg.element14.com/b/multicomp-pro

multicomp PRO