

RAA210030

5V, 3A Step-Down DC/DC Mini Module with Integrated Inductor

The RAA210030 power module is a compact, single-channel, synchronous step-down, non-isolated complete power supply, capable of delivering up to 3A of continuous current. By operating from a single 2.7V to 5.5V input power rail and integrating the controller, gate driver, power inductor, and MOSFETs, the RAA210030 is optimized for space constrained applications.

Based on a peak current mode control scheme, the RAA210030 provides fast transient response and excellent loop stability. The output voltage can be set as low as 0.6V, with setpoint accuracy better than ±1.5% over line, load, and temperature. The operating frequency has a 2MHz default setting, however it can also be set from 500kHz to 4MHz by an external resistor. The external synchronization is also supported with an external clock signal up to 4MHz. The RAA210030 supports 100% duty cycle operation to minimize switching losses with typically 300mV dropout voltage. A dedicated enable pin and power-good flag allow for easy system power rails sequencing.

The RAA210030 can be configured for pulsed frequency modulation (PFM) or forced pulse width modulation (FPWM) at light load. FPWM reduces noise and RF interference, while PFM provides higher efficiency by reducing switching losses at light loads.

An array of protection features, including input Undervoltage Lockout (UVLO), Overcurrent Protection (OCP), output Overvoltage Protection (OVP), and Over-Temperature Protection (OTP), ensures safe operations under abnormal operating conditions.

The RAA210030 is available in a compact RoHS compliant 3mm×3mm×1.08mm (1.15mm MAX) dual flat no-lead (DFN) embedded laminate package.

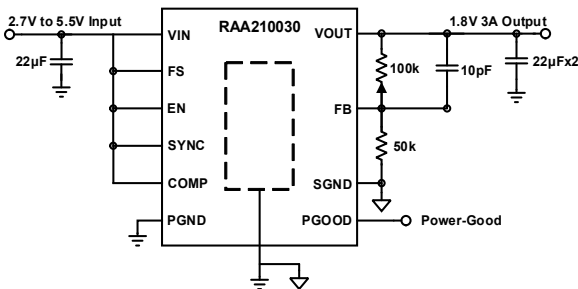

Figure 1. Typical Application Circuit

Features

- 3A complete power supply
 - Integrates controller, gate driver, MOSFETs, and inductor
- 2.7V to 5.5V input voltage range
- Adjustable output voltage
 - As low as 0.6V with ±1.5% accuracy over line, load, and temperature
 - Up to 95% efficiency
- Default 2MHz current mode control operation
 - 500kHz to 4MHz resistor adjustable
 - External synchronization up to 4MHz
 - 100% duty cycle
- Dedicated enable pin and power-good flag
- Internal 1ms soft-start time
- Selectable PFM or FPWM mode
- Soft-stop output discharge
- UVLO, OCP, negative OCP, OVP, and OTP
 - OCP/Short-Circuit Protection (SCP) hiccup mode
- Compact RoHS compliant 3mm×3mm×1.08mm (1.15mm Max) dual flat no-lead (DFN) embedded laminate package

Applications

- Telecom, Industrial, optical, and medical equipment
- Point-of-load conversions
- MCU, MPU, DSP, and FPGA

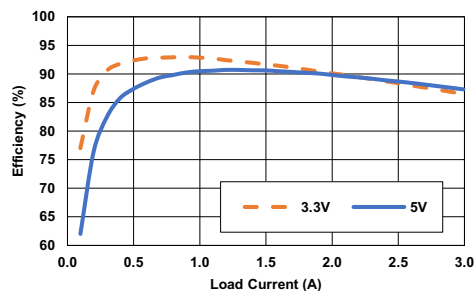

Figure 2. Efficiency V_{OUT} = 1.8V, PWM Mode

Contents

1. Overview	4
1.1 Typical Application Circuits	4
1.2 Block Diagram	5
2. Pin Information	6
2.1 Pin Assignments	6
2.2 Pin Descriptions	6
3. Specifications	8
3.1 Absolute Maximum Ratings	8
3.2 ESD Ratings	8
3.3 Thermal Information	8
3.4 Recommended Operating Conditions	8
3.5 Electrical Specifications	9
4. Typical Performance Curves	11
4.1 Efficiency Performance	11
4.2 Output Voltage Ripple	12
4.3 Load Transient Response Performance	12
4.4 Start-Up and Shutdown Waveforms	14
4.5 Derating	15
5. Functional Description	16
5.1 PWM Control Scheme	16
5.2 SKIP MODE	16
5.3 Frequency Adjustment	17
5.4 Overcurrent Protection (OCP)	17
5.5 Negative Current Protection	18
5.6 Power-Good	18
5.7 Undervoltage Lockout (UVLO)	18
5.8 Soft Start-Up	18
5.9 External Synchronization Control	18
5.10 Enable	19
5.11 Discharge Mode (Soft-Stop)	19
5.12 100% Duty Cycle	19
5.13 Thermal Shutdown	19
6. Application Information	20
6.1 Output Voltage Programming	20
6.2 Switching Frequency Selection	20
6.3 Input Capacitor Selection	20
6.4 Output Capacitor Selection	21
7. Layout Guidelines	21
7.1 Layout Considerations	21
7.2 Thermal Considerations	23
8. Package Description	23
8.1 PCB Layout Pattern Design	23
8.2 Thermal Vias	23
8.3 Stencil Pattern Design	23

8.4	Reflow Parameters	24
9.	Package Outline Drawing	25
10.	Ordering Information	26
11.	Revision History	26

1. Overview

1.1 Typical Application Circuits

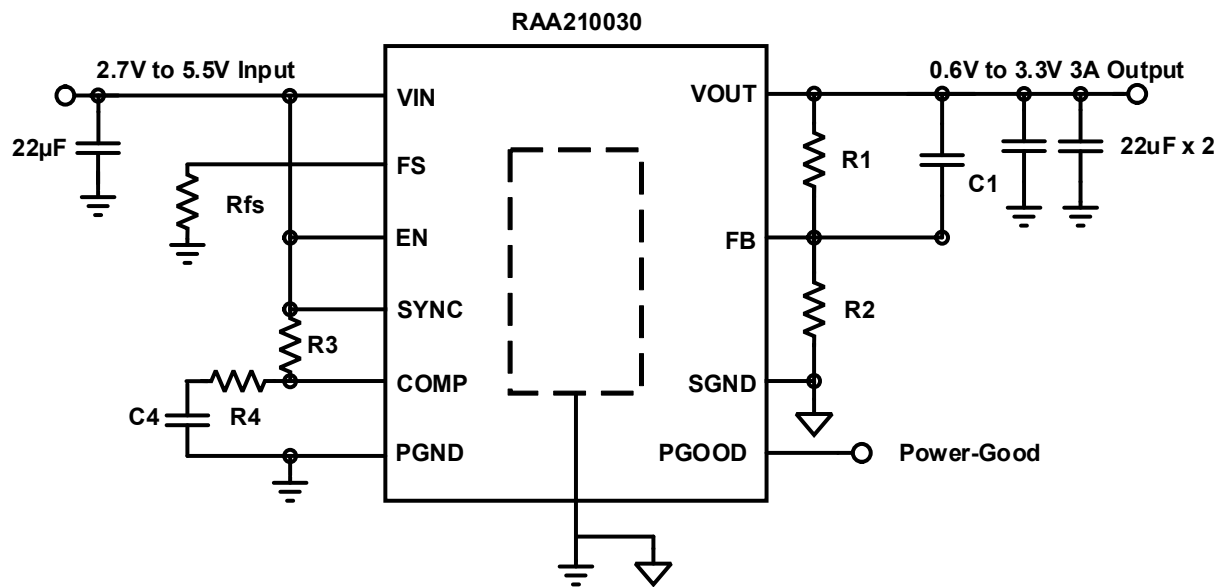

Figure 3. Typical Application Circuit for $V_{IN} = 2.7V$ to $5.5V$ and $V_{OUT} = 0.6V$ to $3.3V$

1.2 Block Diagram

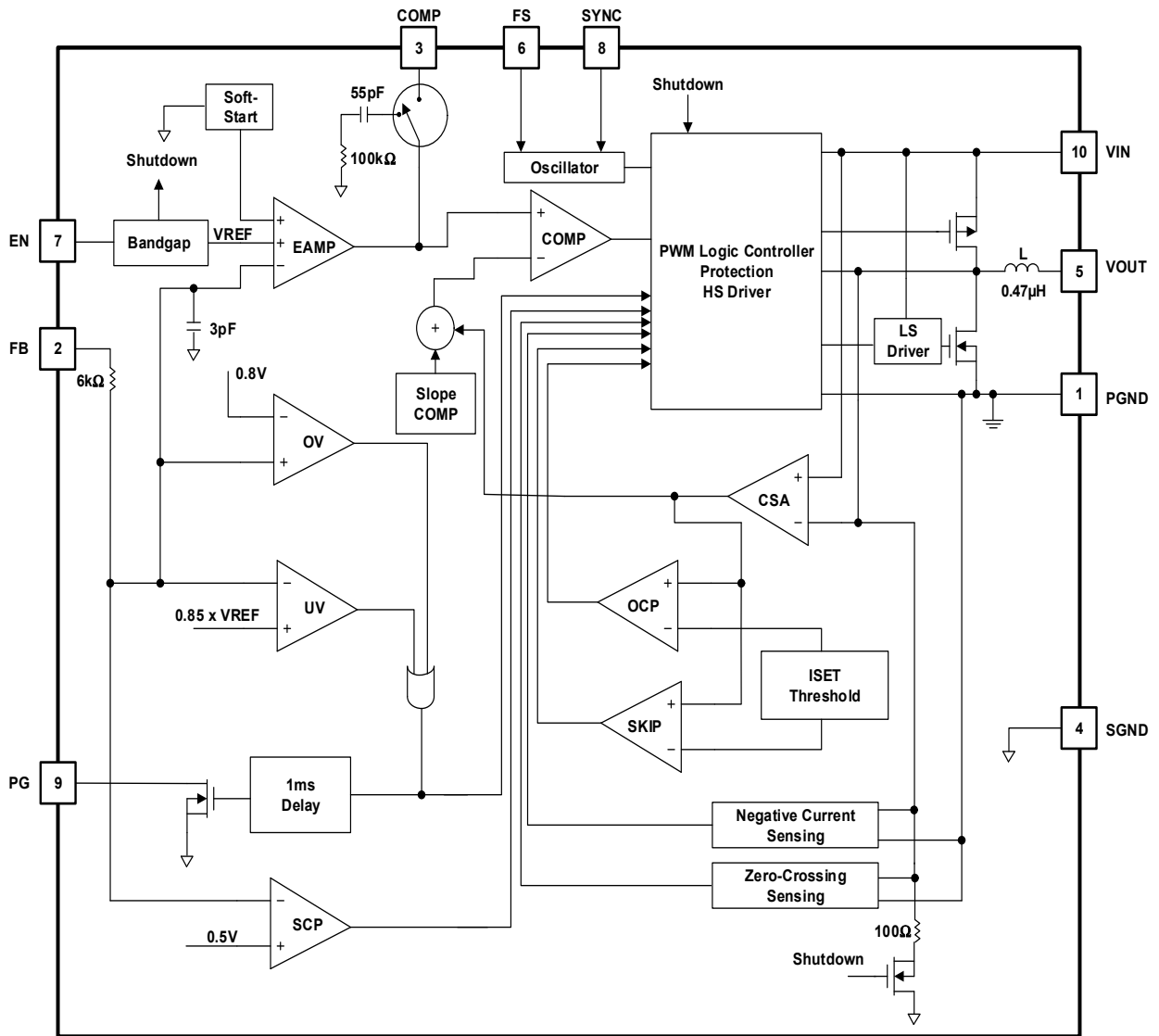
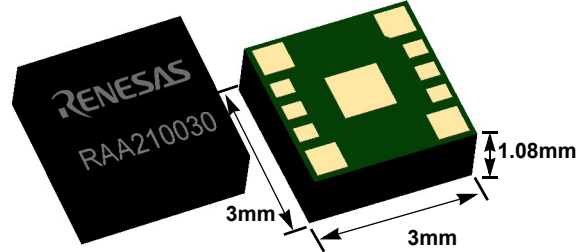
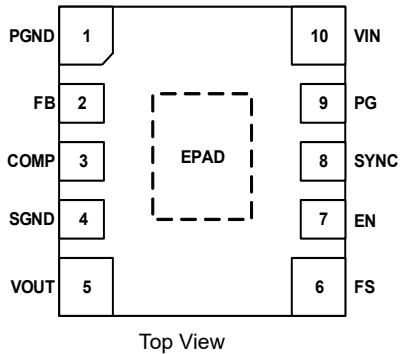

Figure 4. Block Diagram

2. Pin Information

2.1 Pin Assignments



2.2 Pin Descriptions

Pin Number	Pin Name	Function
1	PGND	Power ground. Connect it close to the (-) terminals of the external input capacitors and output capacitors.
2	FB	Voltage setting pin. The module output voltage is set by an external resistor divider connected to FB. With a properly selected divider, the output voltage is set to any voltage between 0.6V and 5V. Renesas also recommends placing a ceramic capacitor in parallel to ensure system stability at extreme operation conditions. Table 1 lists for the resistor and capacitor values for various typical output voltages.
3	COMP	Compensation pin. COMP is the output of the transconductance error amplifier. For most applications, directly connect COMP to VIN to select internal compensation to stabilize the system and achieve an optimal transient response. For applications where external compensation is required, connect COMP to SGND with an external compensation network.
4	SGND	Signal ground. Must connect it to EPAD for proper electrical performance. See Layout Guidelines for more information.
5	VOUT	Power output of the module. Place the output capacitors as close as possible to the module output. See Layout Guidelines for more information.
6	FS	Frequency selection pin. This pin sets the module switching frequency by connecting a resistor to SGND. The frequency of operation can be programmed between 500kHz to 4MHz. The default frequency is 2MHz if FS is connected to VIN.
7	EN	Module enable pin. Enable the module by driving EN high. Shuts down the module and discharge the output capacitor when driven low. Typically tied to VIN directly. Note: Do not leave this pin floating.
8	SYNC	Mode Selection pin. Connect to logic high or input voltage VIN for FPWM mode. Connect to logic low or ground for PFM mode. Drive with a 500kHz to 4MHz square wave for external synchronization. There is an internal 1MΩ pull-down resistor to prevent an undefined logic state in case of SYNC pin float.
9	PG	Power-good pin. Power-good is an open-drain output. Use a 10kΩ to 100kΩ pull-up resistor connected between VIN and PG. During power-up or EN start-up, the PG rising edge is delayed by 1ms after the output is in regulation.
10	VIN	Power input of the module. Tie directly to the input rail between 2.7V~5.5V. Note: You must place minimum total 22μF input ceramic capacitors as close as possible to the module input. Add additional capacitance if possible. See Layout Guidelines for more information
-	EPAD	Power ground. Must connect it to SGND for proper electrical performance. Place as many vias as possible under the EPAD for optimal thermal performance.

Table 1. RAA210030 Design Guide Matrix (See Figure 3)

Case	V _{IN} (V)	V _{OUT} (V)	R ₁ (kΩ)	R ₂ (kΩ)	R ₃ (kΩ)	R ₄ (kΩ)	Freq (MHz)	R _{FS} (kΩ)	C ₁ (pF)	C ₄ (pF)
1	3.3	0.6	0.1	Open	Open	33	1	206	Open	680
2	3.3	0.8	33.2	100	Open	33	1.4	143	Open	680
3	3.3	0.9	50	100	Open	33	1.5	133	Open	680
4	3.3	1	66.5	100	Open	33	1.7	115	Open	680
5	3.3	1.2	100	100	Open	33	2	96	Open	680
6	3.3	1.5	100	66.5	0	Open	2	96	10	Open
7	3.3	1.8	100	50	0	Open	2	96	10	Open
8	3.3	2.5	100	31.6	0	Open	2	96	Open	Open
9	5	1	66.5	100	Open	33	1	206	Open	680
10	5	1.2	100	100	Open	33	1.4	143	Open	680
11	5	1.5	100	66.5	0	Open	1.7	115	10	Open
12	5	1.8	100	50	0	Open	2	96	10	Open
13	5	2.5	100	31.6	0	Open	2	96	Open	Open
14	5	3.3	100	22.1	0	Open	2	96	Open	Open

Table 2. Recommended Input/Output Capacitor

Name	Vendor	Value	Part Number	Number
Input Capacitor	Murata	22μF, 10V, 0603, X5R	GRM188R61A226ME15D	1
	TDK	22μF, 10V, 0603, X5R	C1608X5R1A226M080AC	1
Output Capacitor	Murata	22μF, 6.3V, 0402, X5R	GRM158R60J226ME01D	2
	TDK	22μF, 10V, 0603, X5R	C1608X5R1A226M080AC	2

3. Specifications

3.1 Absolute Maximum Ratings

CAUTION: Do not operate at or near the maximum ratings listed for extended periods of time. Exposure to such conditions can adversely impact product reliability and result in failures not covered by warranty.

Parameter	Minimum	Maximum	Unit
VIN to PGND	-0.3	+5.8 (DC) or +7V (20ms)	V
EN, FS, PG, FB, SYNC, COMP to SGND	-0.3	$V_{IN} + 0.3$	V
VOU to PGND	-0.3	$V_{IN} + 0.3$	V

3.2 ESD Ratings

ESD Model/Test	Rating	Unit
Human Body Model (Tested per JS-001-2017)	3.5	kV
Charged Device Model (Tested per JS-002-2018)	2	kV
Latch-Up (Tested per JESD78E; Class 2, Level A, +125°C)	100	mA

3.3 Thermal Information

Thermal Resistance (Typical)	θ_{JA} (°C/W) ^[1]	θ_{JC} (°C/W) ^[2]
10 Ld Dual Flat Embedded Laminate Package	33.84	16.4

- θ_{JA} is measured in free air with the module mounted on a 4-layer thermal test board 3x4.5 inch in size with significant coverage of 2oz Cu on both top and bottom layers, and 1oz Cu on internal layers, with numerous vias.
- For θ_{JC} , the case temperature location is the center of the exposed metal pad on the package underside.

Parameter	Minimum	Maximum	Unit
Storage Temperature Range	-65	+150	°C
Pb-Free Reflow Profile	See TB493		

3.4 Recommended Operating Conditions

Parameter	Minimum	Maximum	Unit
VIN to GND	2.7	5.5	V
Output Voltage, V_{OUT}	0.6	5	V
Output Current, I_{OUT}	0	3	A
Junction Temperature Range, T_J	-40	+125	°C

3.5 Electrical Specifications

Unless otherwise noted, all parameter limits are established across the recommended operating conditions and the specification limits are measured at the following conditions: $T_A = -40^{\circ}\text{C}$ to $+125^{\circ}\text{C}$, $V_{IN} = 3.6\text{V}$, $V_{OUT} = 1.2\text{V}$, unless otherwise noted. Typical specifications are measured at $T_A = +25^{\circ}\text{C}$. **Boldface limits apply across the internal junction temperature range, -40°C to $+125^{\circ}\text{C}$.**

Parameter	Symbol	Test Conditions	Min ^[1]	Typ	Max ^[1]	Unit
Module Input Supply						
Input Voltage Range	V_{IN}		2.7		5.5	V
V_{IN} Undervoltage Lockout Threshold	V_{UVLO}	Rising, no load		2.5	2.7	V
		Falling, no load	2.2	2.45		V
Quiescent Supply Current	I_{VIN}	SYNC = $V_{IN} = 3.6\text{V}$, $f_{SW} = 2\text{MHz}$, EN = high, $I_{OUT} = 0\text{A}$		19	25	mA
		SYNC = $V_{IN} = 5\text{V}$, $f_{SW} = 2\text{MHz}$, EN = high, $I_{OUT} = 0\text{A}$		23	30	mA
Shutdown Supply Current	I_{SD}	SYNC = $V_{IN} = 5.5\text{V}$, EN = low		4.5	10	μA
Output Regulation						
Output Continuous Current Range ^[2]	I_{OUT}		0		3	A
Output Voltage Range ^[2]	V_{OUT_RANGE}		0.6		5	V
Output Voltage Accuracy ^[2]	V_{OUT_ACCY}	Total variation with line, load, and temperature ($-40^{\circ}\text{C} \leq T_J \leq +125^{\circ}\text{C}$)	-1.5		1.5	%
Line Regulation ^[2]	$\frac{\Delta V_{OUT}}{V_{OUT_SET}}$	V_{IN} from 2.7V to 5.5V, $I_{OUT} = 0\text{A}$	-1		1	%
Load Regulation ^[2]	$\frac{\Delta V_{OUT}}{V_{OUT_SET}}$	From 0A to 3A, $V_{IN} = 5\text{V}$	-1		1	%
Output Ripple Voltage	$V_{OUT(AC)}$	$V_{IN} = 5\text{V}$, $V_{OUT} = 1.8\text{V}$, $I_{OUT} = 3\text{A}$, $f_{SW} = 2\text{MHz}$, 22 μF ×2 ceramic capacitor		8		mV _{P-P}
Dynamic Characteristics						
Voltage Change of Positive Load Step	V_{OUT_DP}	Current slew rate = 2.5A/ μs , $V_{IN} = 5\text{V}$, $V_{OUT} = 1.8\text{V}$, $I_{OUT} = 0\text{A}$ to 3A, 22 μF ×2 ceramic capacitor		63		mV
Voltage Change of Negative Load Step	V_{OUT_DN}	Current slew rate = 2.5A/ μs , $V_{IN} = 5\text{V}$, $V_{OUT} = 1.8\text{V}$, $I_{OUT} = 0\text{A}$ to 3A, 22 μF ×2 ceramic capacitor		63		mV
Current Protection						
Current Limit Blanking Time	t_{OCON}			17		clock pulses
Hiccup Time	t_{HICCUP}			8		ms
Positive Peak Current Limit	I_{PLIMIT}		3.7	4.9	6.6	A
Skip Current Limit	I_{SKIP}	See Figure 34 for more detail.	0.6	0.9	1.3	
Negative Current Limit	I_{NLIMIT}		-6	-3	-0.6	A

Parameter	Symbol	Test Conditions	Min ^[1]	Typ	Max ^[1]	Unit
EN Threshold						
Logic Input Low					0.4	V
Logic Input High			0.9			V
EN Logic Input Leakage Current		Pulled up to 3.6V		0.1	1	μA
Default Internal Soft-Starting						
Default Internal Output Ramping Time	t_{SS}	SS = SGND		1		ms
Power-Good						
Output Low Voltage		$I_{PG} = 1\text{mA}$			0.3	V
PG Delay Time (Rising Edge)	t_{PGR}	Time from V_{OUT} reached regulation	0.5	1	2	ms
PG Delay Time (Falling Edge)	t_{PGF}			6.5		μs
PG Leakage Current	I_{PGLKG}	PG = 3.6V		10	100	nA
OVP PG Rising Threshold	V_{PGR_OVP}			0.8		V
UVP PG Rising Threshold	V_{PGR_UVP}		80	86	90	%
UVP PG Hysteresis				5.4		%
Reference Section						
Internal Reference Voltage	V_{REF}			0.600		V
FB Bias Current	I_{FBLKG}	FB = 0.75V		0.1		μA
Compensation						
Error Amplifier Transconductance		Internal Compensation		126		μA/V
		External Compensation		132		μA/V
Current Sense Gain			0.145	0.2	0.25	Ω
PWM Regulator						
Maximum Duty Cycle	d_{MAX}			100		%
Minimum On-Time	t_{ON_MIN}	SYNC = high			105	ns
Oscillator						
Switching Frequency	f_{SW}	$f_{SW} = 2\text{MHz}$	1.6	2	2.4	MHz
		$R_{FS} = 402\text{k}\Omega$		0.5		MHz
		$R_{FS} = 42.2\text{k}\Omega$		4		MHz
Synchronization						
SYNC Synchronization Range	f_{SYNC}		0.5		4	MHz
SYNC Logic Low-to-High Transition Range			0.67	0.76	0.84	V
SYNC Hysteresis				0.17		V
SYNC Logic Input Leakage Current		$V_{IN} = 3.6\text{V}$		4	5	μA

Parameter	Symbol	Test Conditions	Min ^[1]	Typ	Max ^[1]	Unit
Over-Temperature						
Over-Temperature Shutdown	T_{OT-TH}			150		°C
Over-Temperature Hysteresis	T_{OT-HYS}			25		°C

1. Compliance to datasheet limit is assured by one or more methods: production test, characterization, and/or design.
2. Compliance to limits is assured by characterization and design.

4. Typical Performance Curves

4.1 Efficiency Performance

Operating condition: $T_A = +25^\circ\text{C}$, no air flow. Typical values are used unless otherwise noted.

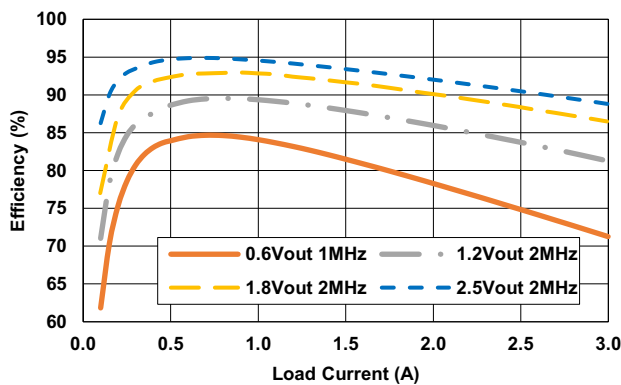

Figure 5. $V_{IN} = 3.3\text{V}$, FPWM

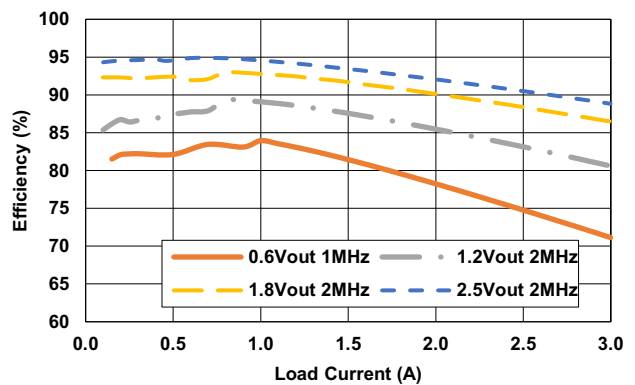

Figure 6. $V_{IN} = 3.3\text{V}$, PFM

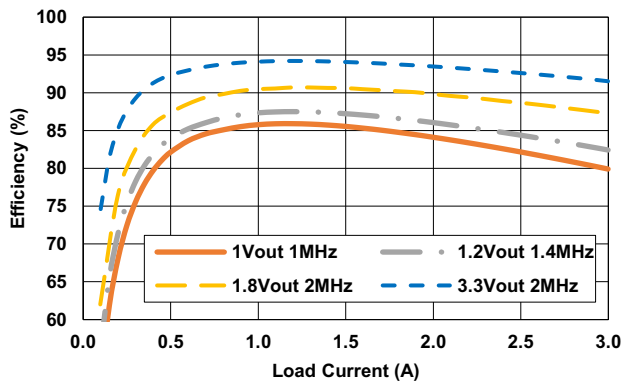

Figure 7. $V_{IN} = 5\text{V}$, FPWM

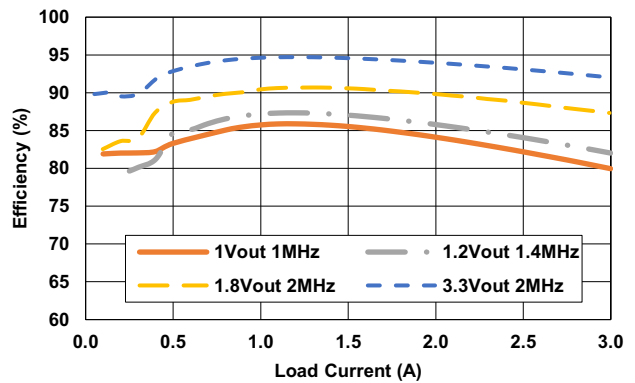

Figure 8. $V_{IN} = 5\text{V}$, PFM

4.2 Output Voltage Ripple

Operating condition: $T_A = +25^\circ\text{C}$, no air flow, FPWM mode. Typical values are used unless otherwise noted.

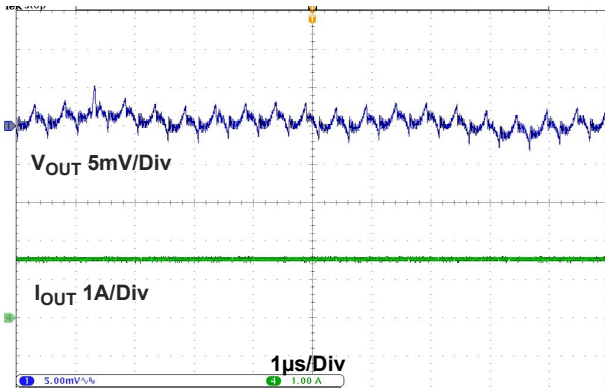

Figure 9. Output Ripple, $V_{IN} = 3.3\text{V}$, $V_{OUT} = 1.8\text{V}$, $f_{SW} = 2\text{MHz}$, Half Load, $C_{OUT} = 22\mu\text{Fx}2$ Ceramic

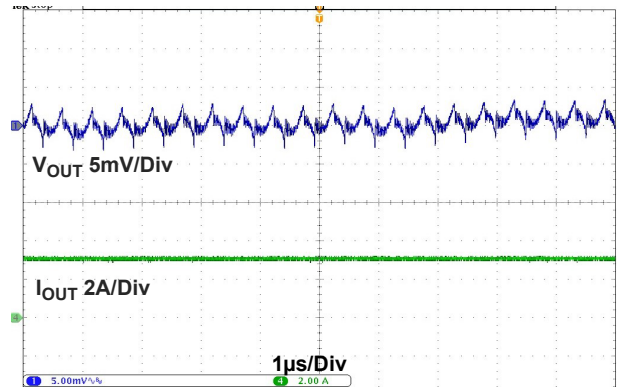

Figure 10. Output Ripple, $V_{IN} = 3.3\text{V}$, $V_{OUT} = 1.8\text{V}$, $f_{SW} = 2\text{MHz}$, Full Load, $C_{OUT} = 22\mu\text{Fx}2$ Ceramic

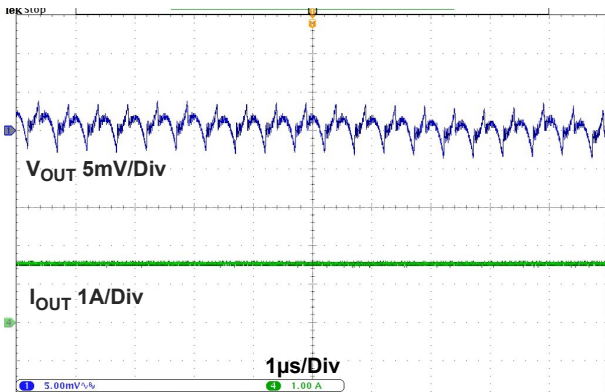

Figure 11. Output Ripple, $V_{IN} = 5\text{V}$, $V_{OUT} = 1.8\text{V}$, $f_{SW} = 2\text{MHz}$, Half Load, $C_{OUT} = 22\mu\text{Fx}2$ Ceramic

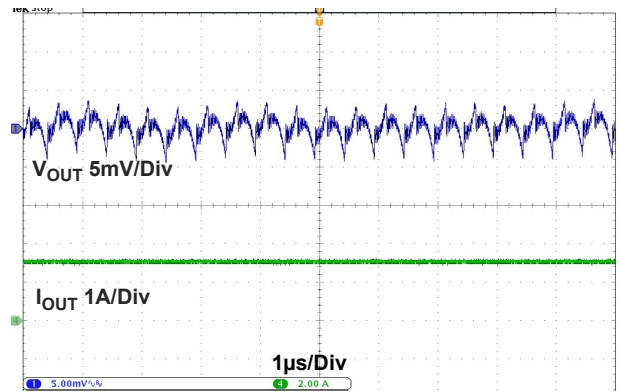

Figure 12. Output Ripple, $V_{IN} = 5\text{V}$, $V_{OUT} = 1.8\text{V}$, $f_{SW} = 2\text{MHz}$, Full Load, $C_{OUT} = 22\mu\text{Fx}2$ Ceramic

4.3 Load Transient Response Performance

Operating condition: $T_A = +25^\circ\text{C}$, no air flow, $C_{OUT} = 2 \times 22\mu\text{F}$, $2.5\text{A}/\mu\text{s}$ step load. Typical values are used unless otherwise noted.

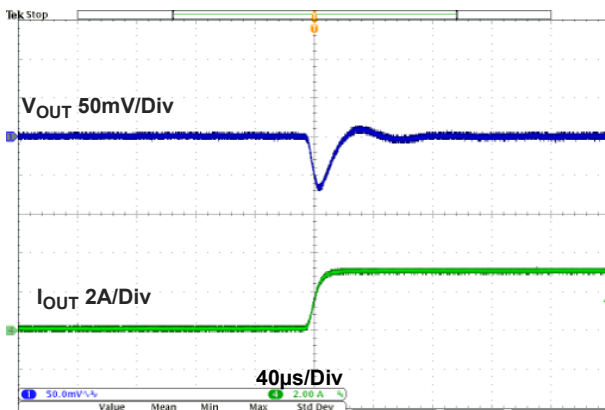

Figure 13. $V_{IN} = 3.3\text{V}$, $V_{OUT} = 1.8\text{V}$, $f_{SW} = 2\text{MHz}$, $0\text{A} \rightarrow 3\text{A}$, FPWM

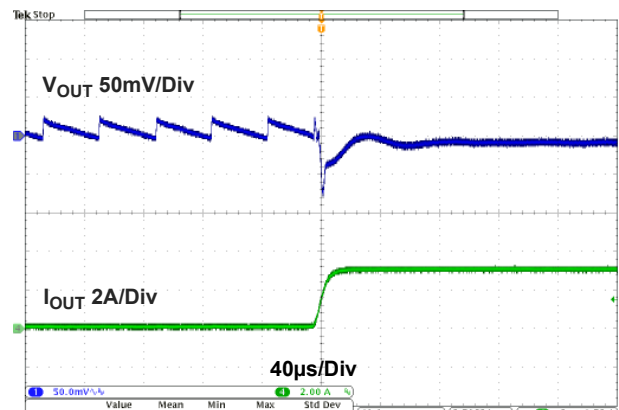

Figure 14. $V_{IN} = 3.3\text{V}$, $V_{OUT} = 1.8\text{V}$, $f_{SW} = 2\text{MHz}$, $0\text{A} \rightarrow 3\text{A}$, PFM

Operating condition: $T_A = +25^\circ\text{C}$, no air flow, $C_{OUT} = 2 \times 22\mu\text{F}$, $2.5\text{A}/\mu\text{s}$ step load. Typical values are used unless otherwise noted.

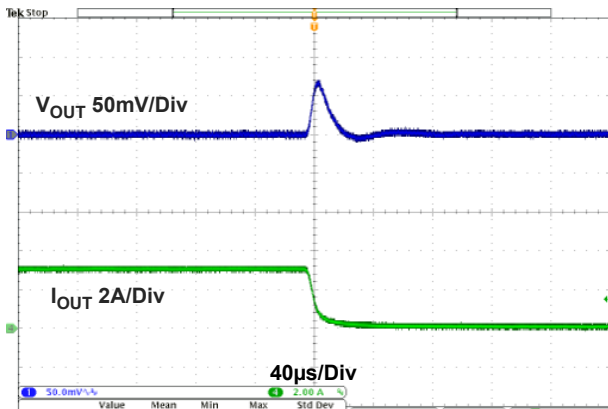

Figure 15. $V_{IN} = 3.3\text{V}$, $V_{OUT} = 1.8\text{V}$, $f_{SW} = 2\text{MHz}$, $3\text{A} \rightarrow 0\text{A}$, FPWM

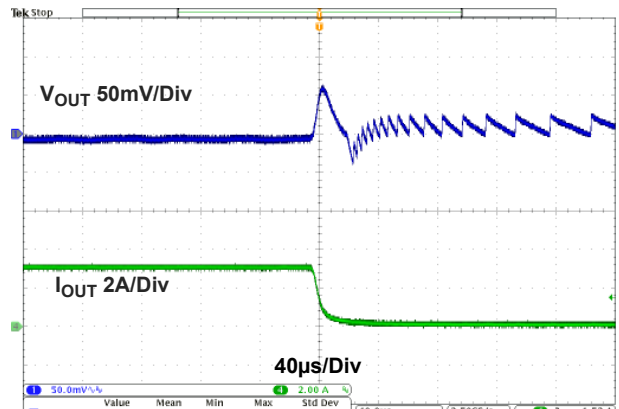

Figure 16. $V_{IN} = 3.3\text{V}$, $V_{OUT} = 1.8\text{V}$, $f_{SW} = 2\text{MHz}$, $3\text{A} \rightarrow 0\text{A}$, PFM

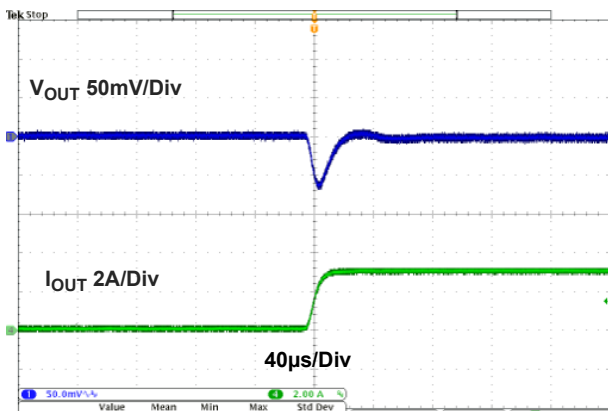

Figure 17. $V_{IN} = 5\text{V}$, $V_{OUT} = 1.8\text{V}$, $f_{SW} = 2\text{MHz}$, $0\text{A} \rightarrow 3\text{A}$, FPWM

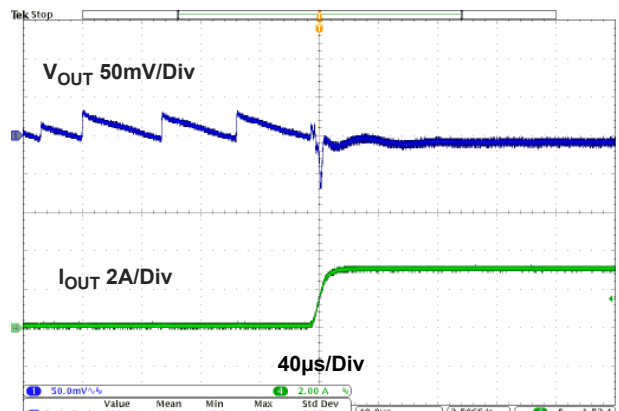

Figure 18. $V_{IN} = 5\text{V}$, $V_{OUT} = 1.8\text{V}$, $f_{SW} = 2\text{MHz}$, $0\text{A} \rightarrow 3\text{A}$, PFM

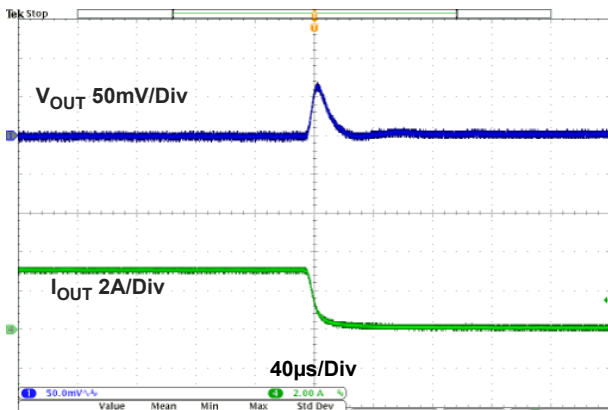

Figure 19. $V_{IN} = 5\text{V}$, $V_{OUT} = 1.8\text{V}$, $f_{SW} = 2\text{MHz}$, $3\text{A} \rightarrow 0\text{A}$, FPWM

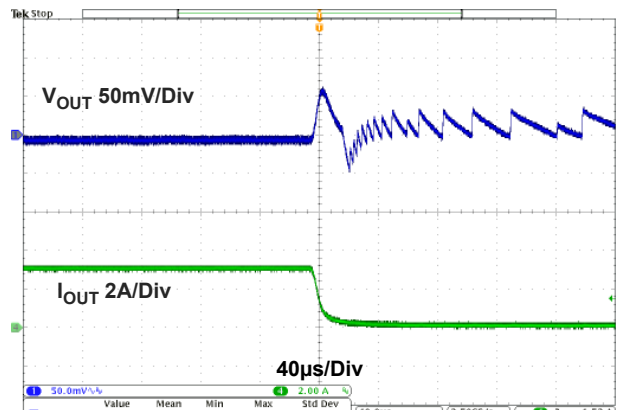

Figure 20. $V_{IN} = 5\text{V}$, $V_{OUT} = 1.8\text{V}$, $f_{SW} = 2\text{MHz}$, $3\text{A} \rightarrow 0\text{A}$, PFM

4.4 Start-Up and Shutdown Waveforms

Operating condition: $T_A = +25^{\circ}\text{C}$, FPWM mode, no air flow. Typical values are used unless otherwise noted.

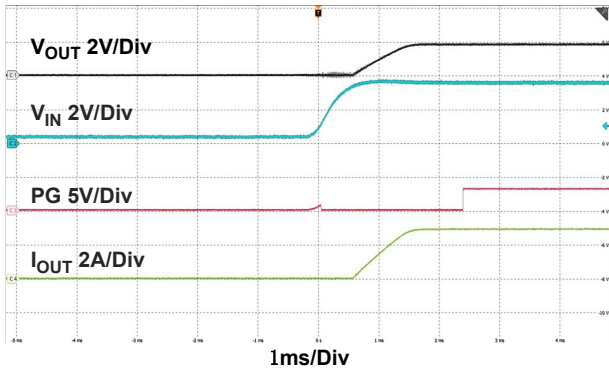

Figure 21. V_{IN} Start-Up Waveforms; $V_{IN} = 3.3\text{V}$, $V_{OUT} = 1.8\text{V}$, $I_{OUT} = 3\text{A}$

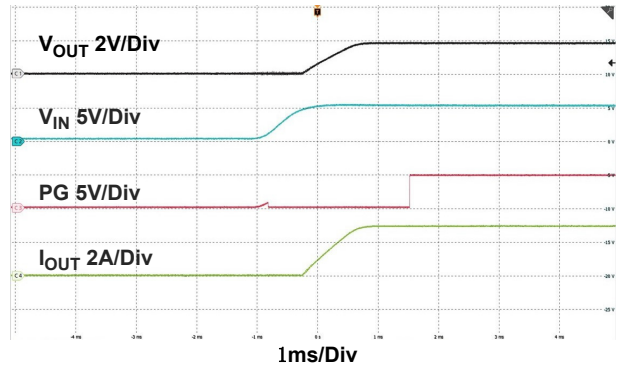

Figure 22. V_{IN} Start-up Waveforms; $V_{IN} = 5\text{V}$, $V_{OUT} = 1.8\text{V}$, $I_{OUT} = 3\text{A}$

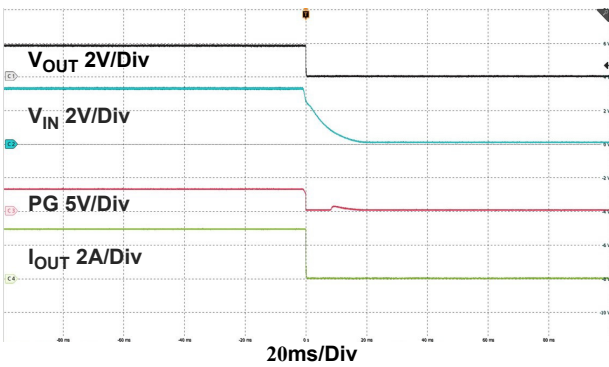

Figure 23. V_{IN} Shutdown Waveforms; $V_{IN} = 3.3\text{V}$, $V_{OUT} = 1.8\text{V}$, $I_{OUT} = 3\text{A}$

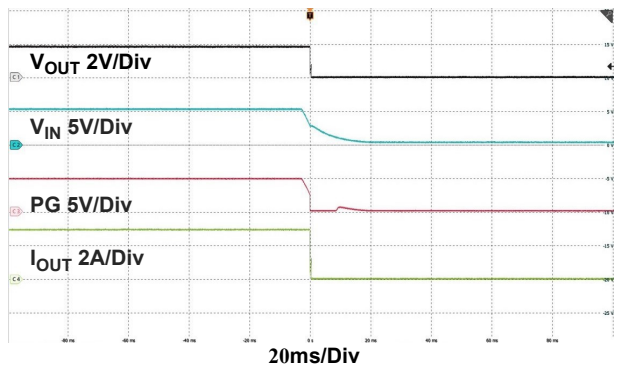

Figure 24. V_{IN} Shutdown Waveforms; $V_{IN} = 5\text{V}$, $V_{OUT} = 1.8\text{V}$, $I_{OUT} = 3\text{A}$

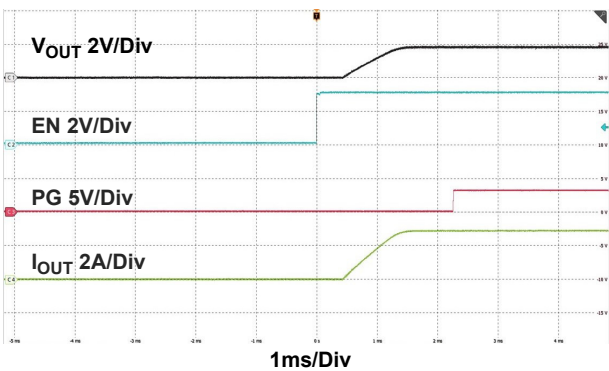

Figure 25. EN Start-Up Waveforms; $V_{IN} = 3.3\text{V}$, $V_{OUT} = 1.8\text{V}$, $I_{OUT} = 3\text{A}$

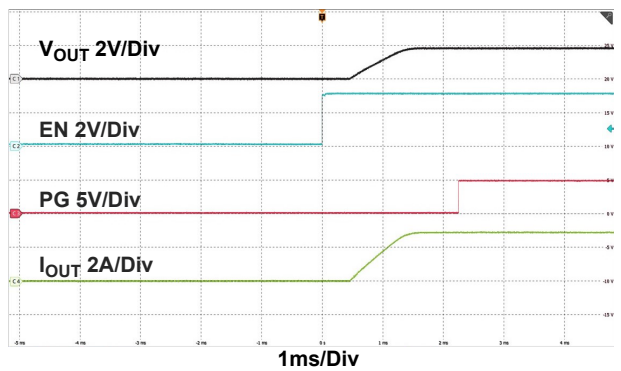

Figure 26. EN Start-up Waveforms; $V_{IN} = 5\text{V}$, $V_{OUT} = 1.8\text{V}$, $I_{OUT} = 3\text{A}$

Operating condition: $T_A = +25^\circ\text{C}$, FPWM mode, no air flow. Typical values are used unless otherwise noted. (Cont.)

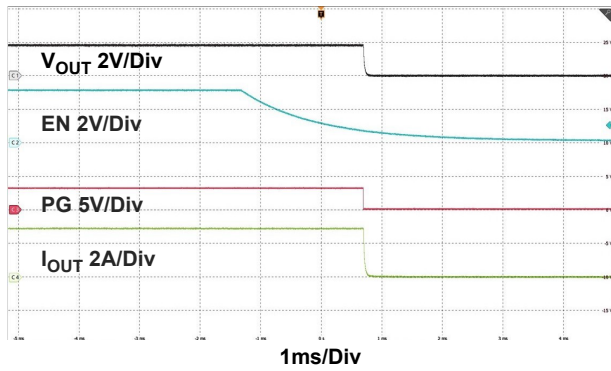

Figure 27. EN Shutdown Waveforms; $V_{IN} = 3.3\text{V}$, $V_{OUT} = 1.8\text{V}$, $I_{OUT} = 3\text{A}$

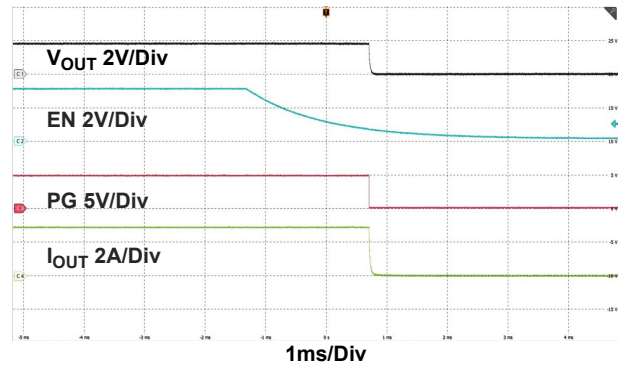

Figure 28. EN Shutdown Waveforms; $V_{IN} = 5\text{V}$, $V_{OUT} = 1.8\text{V}$, $I_{OUT} = 3\text{A}$

4.5 Derating

FPWM operation. All of the following curves were plotted at $T_J = +120^\circ\text{C}$.

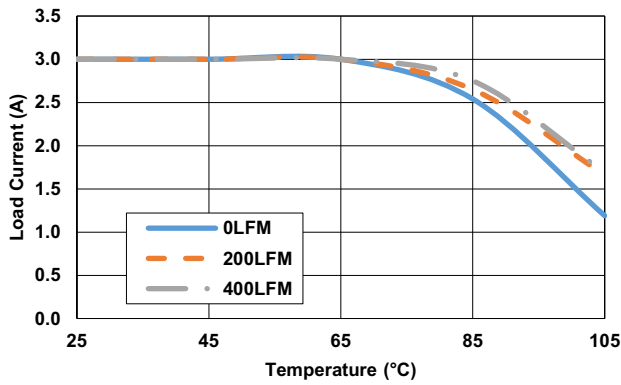

Figure 29. $V_{IN} = 3.3\text{V}$, $V_{OUT} = 1.2\text{V}$, $f_{SW} = 2\text{MHz}$

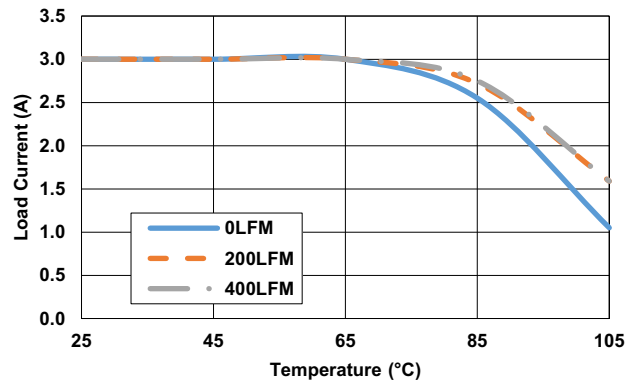

Figure 30. $V_{IN} = 5\text{V}$, $V_{OUT} = 1.2\text{V}$, $f_{SW} = 1.4\text{MHz}$

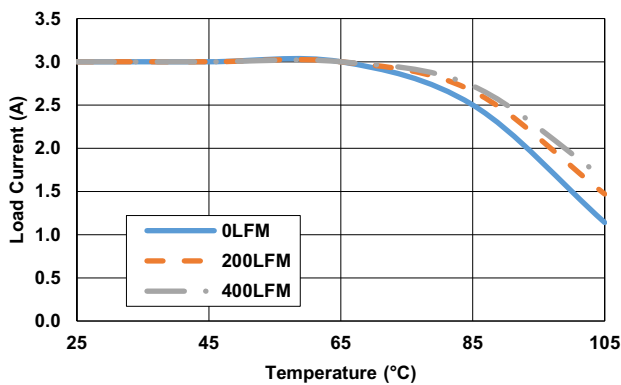

Figure 31. $V_{IN} = 3.3\text{V}$, $V_{OUT} = 1.8\text{V}$, $f_{SW} = 2\text{MHz}$

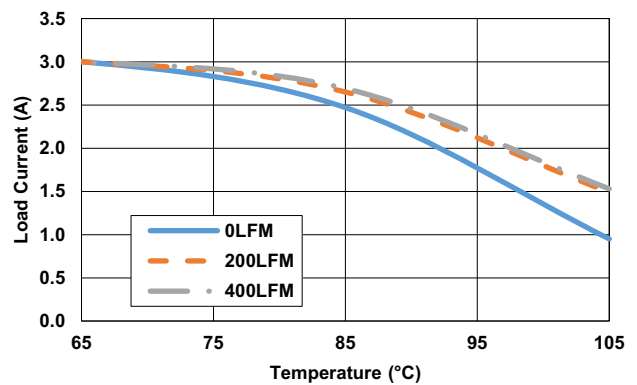

Figure 32. $V_{IN} = 5\text{V}$, $V_{OUT} = 1.8\text{V}$, $f_{SW} = 2\text{MHz}$

5. Functional Description

The RAA210030 is a compact 3A step-down high efficiency power module optimized for space constrained applications. The module switches at 2MHz by default when the FS pin is shorted to VIN. The switching frequency is also adjustable from 500kHz to 4MHz through a resistor, R_{FS} , from FS to SGND. Peak current mode control scheme is implemented for a fast transient response. By shorting the COMP pin to VIN, the module uses internal compensation to stabilize the system and optimize transient response. Other features include soft-stop output discharge, external synchronization, 100% duty cycle operation, and low quiescent current. The supply current is typically only 4.5µA when the module is shut down.

5.1 PWM Control Scheme

The RAA210030 employs peak current-mode Pulse-Width Modulation (PWM) for fast transient response and pulse-by-pulse current limiting. Pulling the SYNC pin high (>0.8V) forces the module into FPWM mode. As shown in Figure 4, the current loop consists of the oscillator, PWM comparator, a current-sensing circuit, and slope compensation for the current loop stability. The slope compensation is 440mV/Ts, which changes with frequency. The gain for the current-sensing circuit is typically 200mV/A. The control reference for the current loops comes from the output of the Error Amplifier (EAMP).

The PWM operation is initialized by the clock from the oscillator. The P-channel MOSFET is turned on at the beginning of a PWM cycle and the current in the MOSFET starts to ramp up. When the sum of the Current-Sense Amplifier (CSA) and the slope compensation reaches the control reference of the current loop, the PWM comparator COMP sends a signal to the PWM logic to turn off the P-channel MOSFET and turn on the N-channel MOSFET. The N-channel MOSFET stays on until the end of the PWM cycle. Figure 33 shows the typical operating waveforms during the PWM operation. The dotted lines illustrate the sum of the slope compensation ramp and the output of the CSA.

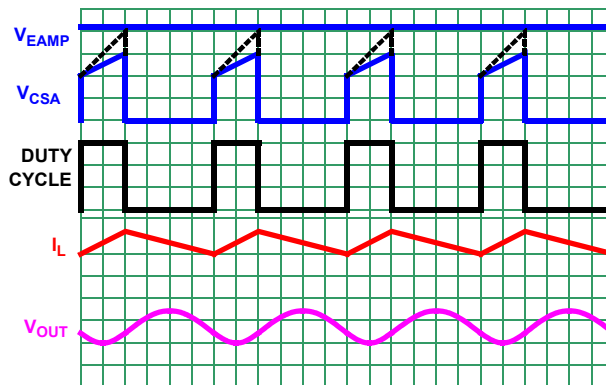

Figure 33. PWM Operation Waveforms

The output voltage is regulated by controlling the V_{EAMP} voltage to the current loop. The band-gap circuit outputs a 0.6V reference voltage to the voltage loop. The feedback signal comes from the FB pin. The soft-start block only affects the operation during start-up and is discussed separately, see [Soft Start-Up](#). The error amplifier is a transconductance amplifier that converts the voltage error signal to a current output. When the COMP is tied to VIN, the voltage loop is internally compensated with the 55pF and 100kΩ RC network.

5.2 SKIP MODE

Pulling the SYNC pin low (<0.4V) forces the converter into PFM mode. The RAA210030 enters a pulse-skipping mode at light load to minimize the switching loss by reducing the switching frequency. Figure 34 illustrates the skip-mode operation. A zero-cross sensing circuit shown in Figure 4 monitors the N-channel MOSFET current for zero crossing. When 16 consecutive cycles are detected, the regulator enters the skip mode. During the sixteen detecting cycles, the current in the inductor is allowed to become negative. The counter is reset to zero when the current in any cycle does not cross zero. When the skip mode is entered, the pulse modulation starts being

controlled by the SKIP comparator shown in Figure 4. Each pulse cycle is still synchronized by the PWM clock. The P-channel MOSFET is turned on at the rising edge of the clock and turned off when the output is higher than 2% of the nominal regulation or when its current reaches the peak Skip current limit value. Then, the inductor current stays at zero (the internal clock is disabled), and the output voltage reduces gradually because of the load current discharging the output capacitor. When the output voltage drops to the nominal voltage, the P-channel MOSFET is turned on again at the rising edge of the internal clock as it repeats the previous operations. The regulator resumes normal FPWM mode operation when the output voltage drops 2% below the nominal voltage.

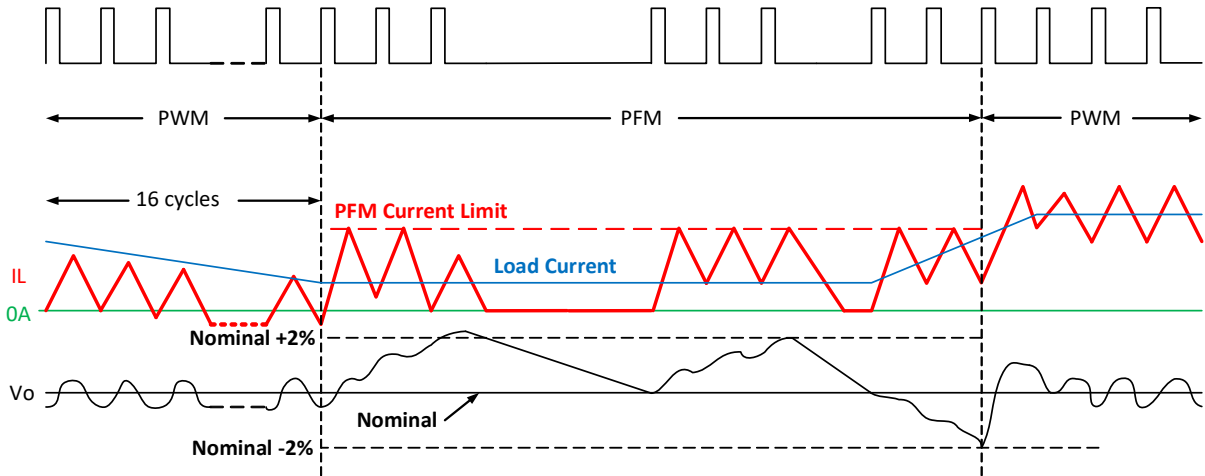

Figure 34. Skip Mode Operation Waveforms

5.3 Frequency Adjustment

The switching frequency of RAA210030 is adjustable ranging from 500kHz to 4MHz using a simple resistor R_{FS} across FS to SGND. The switching frequency setting is based on Equation 1:

$$(EQ. 1) \quad R_{FS}[k\Omega] = \frac{220 \cdot 10^3}{f_{OSC}[kHz]} - 14$$

When the FS pin is directly tied to VIN, the frequency of operation is fixed at 2MHz. See Table 1 to help with the selection of switching frequency for typical operation conditions. More detailed information on recommended switching frequency is provided in the Switching Frequency Selection section.

5.4 Overcurrent Protection (OCP)

The overcurrent protection is implemented by monitoring the CSA output with the OCP comparator, as shown in Figure 4. The current-sensing circuit has a gain of 200mV/A, from the P-channel MOSFET current to the CSA output. When the CSA output reaches the threshold, the OCP comparator is tripped and turns off the P-channel MOSFET immediately. The overcurrent function protects the module from a shorted output by monitoring the current flowing through the P-channel MOSFET.

With the detection of an overcurrent condition, the P-channel MOSFET is immediately turned off and is not turned on again until the next switching cycle. With the detection of the initial overcurrent condition, the overcurrent fault counter is set to 1. During the subsequent cycle, if another overcurrent condition is detected, the OC fault counter is incremented. If there are 17 sequential OC fault detections, the module shuts down under an overcurrent fault condition. An overcurrent fault condition results in the module attempting to restart in Hiccup mode within the delay of eight soft-start periods. At the end of the eighth soft-start wait period, the fault counters are reset and soft-start is attempted again. If the overcurrent condition goes away during the delay of eight soft-start periods, the output resumes back into regulation after the Hiccup mode expires as shown in Figure 35.

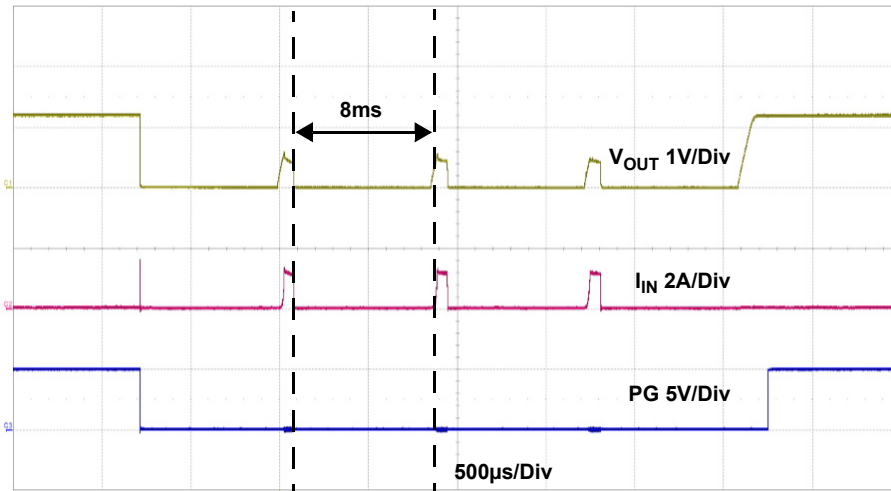

Figure 35. OCP Response: Output Short-Circuited from No Load to Ground and Released, $V_{OUT} = 1.2V$

5.5 Negative Current Protection

Similar to overcurrent, the negative current protection is realized by monitoring the current across the low-side N-channel MOSFET, as shown in Figure 4. When the valley point of the inductor current reaches $-3A$ for four consecutive cycles, both P-channel MOSFET and N-channel MOSFET are turned off. The 100Ω in parallel to the N-channel MOSFET activates discharging the output into regulation. The control begins to switch when output is within regulation.

5.6 Power-Good

Power-Good (PG) is the open-drain output of a window comparator that continuously monitors the module output voltage. PG is actively held low when EN is low and during the module soft-start period. After the 1ms delay of the soft-start period, PG becomes high impedance as long as the output voltage is within the nominal regulation voltage set by V_{FB} . During an output overvoltage fault condition (output voltage is 33% higher than nominal value) or an output undervoltage fault condition (output voltage is 15% lower than nominal value), PG is pulled low. Any fault condition forces PG low until the fault condition is cleared during soft-start. For logic level output voltages, connect an external pull-up resistor between PG and VIN. A $100k\Omega$ resistor works well in most applications.

5.7 Undervoltage Lockout (UVLO)

When the input voltage is below the Undervoltage Lockout (UVLO) threshold, the module is disabled.

5.8 Soft Start-Up

The soft start-up reduces the inrush current during start-up. The soft-start block outputs a ramp reference to the input of the error amplifier. This voltage ramp limits the inductor current and the output voltage rise time so that the output voltage rises in a controlled fashion. When V_{FB} is less than $0.1V$ at the beginning of the soft-start, the switching frequency is reduced to $200kHz$, so that the output can start-up smoothly at light load condition. The RAA210030 supports pre-biased output condition during soft start-up. The default soft start-up period is approximately 1ms.

5.9 External Synchronization Control

The operating frequency can be synchronized up to $4MHz$ by an external signal applied to the SYNC pin. The rising edge of SYNC signal triggers the rising edge of PWM ON pulse. To ensure proper operation, Renesas recommends using an external SYNC frequency within $\pm 25%$ of the switching frequency set by the FS pin.

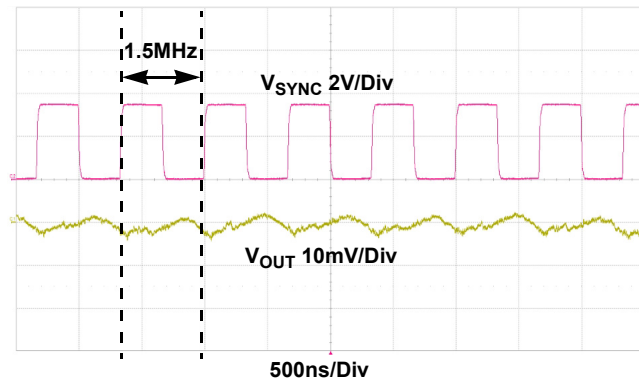

Figure 36. External Frequency Synchronization Waveform, $V_{IN} = 5V$, $V_{OUT} = 1.2V$, $f_{SYNC} = 1.5MHz$, $I_{OUT} = 0A$

5.10 Enable

The enable (EN) input allows you to control the turning on or off of the module for purposes such as power-up sequencing. When the module is enabled, there is typically a 600 μ s delay for waking up the band-gap reference and then the soft start-up begins. EN should be held below the logic input low until V_{IN} exceeds V_{UVLO} rising threshold.

5.11 Discharge Mode (Soft-Stop)

When a transition to shutdown mode occurs or the V_{IN} UVLO is set, the discharge function is to ensure a defined down-ramp of the output voltage and keep the output voltage close to 0V. The output voltage is discharged to SGND through an internal 100 Ω switch.

5.12 100% Duty Cycle

The RAA210030 features a 100% duty cycle operation to minimize switching loss. When the input voltage drops to a level that the RAA210030 can no longer maintain the regulation at the output, the module completely turns on the P-channel MOSFET. This is particularly useful in battery-powered applications to make full use of the battery voltage and maximize the operation time.

5.13 Thermal Shutdown

The RAA210030 has built-in thermal protection. When the internal temperature reaches +150 $^{\circ}$ C, the module shuts down. Both MOSFETs are turned off and PG goes low. As the temperature drops to +125 $^{\circ}$ C, the RAA210030 resumes operation by stepping through the soft-start.

6. Application Information

6.1 Output Voltage Programming

The output voltage of the module is programmed by an external resistor divider, R_1 and R_2 in [Figure 3](#). R_2 combined with the internal 100kΩ 0.5% resistor connected from FB to VSENSE forms a resistor divider that sets the output voltage. The output voltage is governed by [Equation 2](#).

$$(EQ. 2) \quad V_{OUT} = V_{REF} \cdot \frac{R_2 + R_1}{R_2}$$

Note: The output voltage accuracy is also dependent on the resistor accuracy of R_1 and R_2 . You need to select high accuracy resistors to achieve the overall output accuracy.

Table 3. Output Voltage Resistor Settings

V_{OUT} (V)	R_1 (kΩ)	R_2 (kΩ)
0.6	0.1	Open
0.8	33.2	100
0.9	50	100
1.0	66.5	100
1.2	100	100
1.5	100	66.5
1.8	100	50
2.5	100	31.6
3.3	100	22.1

6.2 Switching Frequency Selection

With varieties of input and output voltage combinations, you must choose wisely on which frequency to operate at according to the specific applications. The selection of switching frequency for each V_{IN} and V_{OUT} combination needs to take into account a few trade-offs. Typically, lower switching frequency leads to higher efficiency at the cost of higher output voltage ripple. Do not decrease the switching frequency too low because of the negative current protection limit. Do not increase the switching frequency too high because of the minimum on-time limit, especially at low V_{OUT} . Moreover, when the output voltage is relatively high, low switching frequency results in more sub-harmonic oscillation. Therefore, operating frequency needs to be kept relatively high under high V_{OUT} conditions. However, to ensure better thermal performance, limit any increase to the switching frequency.

6.3 Input Capacitor Selection

The selection of the input filter capacitor is based on how much ripple the supply can tolerate on the DC input line. The larger the capacitor, the less ripple expected, however, you need to consider the higher surge current during power-up. The RAA210030 provides a soft-start function that controls and limits the current surge. The total capacitance of the input capacitor is calculated using [Equation 3](#):

$$(EQ. 3) \quad C_{IN(MIN)} = \frac{I_O \cdot D(1-D)}{V_{P-P} \cdot f_{SW}}$$

where:

- $C_{IN(MIN)}$ is the minimum required input capacitance (μF)
- I_O is the output current (A)
- D is the duty cycle
- $V_{P,P}$ is the allowable peak-to-peak voltage (V)
- f_{SW} is the switching frequency (Hz)

Renesas recommends placing a low Equivalent Series Resistance (ESR) ceramic capacitor as close as possible to the module input. This input capacitor reduces voltage ringing created by the switching current across parasitic circuit elements. It also reduces the input noise seen by the module. Moreover, you need to consider the estimated RMS ripple current in choosing ceramic capacitors. The RMS ripple current is calculated using [Equation 4](#).

$$\text{(EQ. 4)} \quad I_{IN(RMS)} = \frac{I_O \sqrt{D(1-D)}}{\eta}$$

See the capacitor datasheet for the RMS current ratings.

Based on the previous considerations, a minimum total input capacitance of $22\mu\text{F}$ is required for the RAA210030. Add additional capacitance if possible. Use ceramic capacitors. The placement of the input ceramic capacitors should be as close as possible to the module input. See [PCB Layout Pattern Design](#) for more information. A bulk input capacitance may also be needed if the input source does not have enough output capacitance. The typical value of bulk input capacitor is $47\mu\text{F}$. In such conditions, this bulk input capacitance can supply the current during output load transient conditions.

6.4 Output Capacitor Selection

Ceramic capacitors with low ESR are typically used as the output capacitors for the RAA210030. To keep the low resistance up to high frequencies and to get narrow capacitance variations with the temperatures, Renesas recommends using dielectric X5R or better. See [Table 2](#) for recommended output capacitor values. Bulk output capacitors that have adequately low ESR, such as low ESR polymer capacitors or a low ESR tantalum capacitor, can also be used in combination with the ceramic capacitors, depending on the output voltage ripple and transient requirements.

7. Layout Guidelines

Careful attention to layout requirements is necessary for successful implementation of the RAA210030 power module. The RAA210030 operates at high switching frequencies. Therefore, an optimized layout can minimize the impacts of high di/dt and dv/dt . Conversely, a poor layout can lead to poor regulation (both line and load), degraded efficiency, increased EMI radiation, noise sensitivity, and thermal stress.

7.1 Layout Considerations

The following are the layout considerations.

- Place the input ceramic capacitors as close as possible to the module input. These ceramic capacitors minimize the high frequency noise by reducing the parasitic inductance of the power loop. Proper placement of these capacitors not only leads to less PHASE node spikes and ringing, but also minimizes the switching noise coupled to the module. Renesas recommends using dielectric X5R or better with a minimum total capacitance of $22\mu\text{F}$ at the module input. A layout example is shown in [Figure 37](#) and [Figure 38](#).
- Use large copper planes to minimize conduction loss and thermal stress for VIN, VOUT, and PGND. Use multiple vias to connect the power planes in different layers.
- Use a separate SGND plane for components that are connected to SGND. Connect SGND and PGND at a single point on the top layer as shown in [Figure 39](#).

- Use a remote-sensing trace to connect to the point-of-load and achieve tight output voltage regulation. Route the remote-sensing trace underneath the PGND layer and avoid routing it near noisy planes. Place a 2Ω resistor close to the output voltage resistor divider and FB pin to damp the noise on the trace.

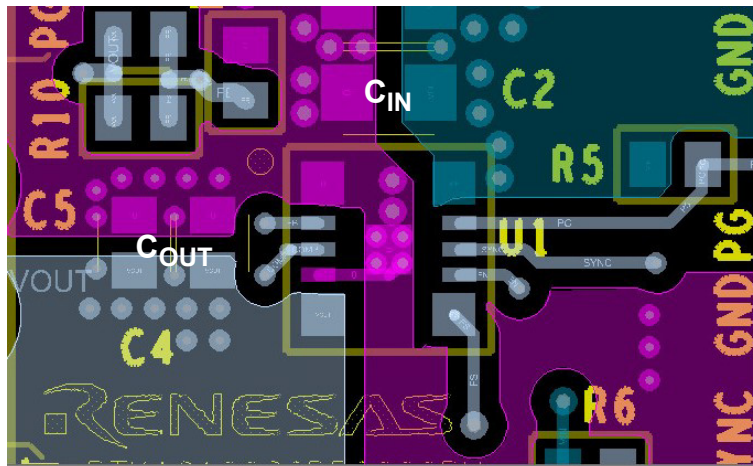

Figure 37. Layout Example - Top Layer

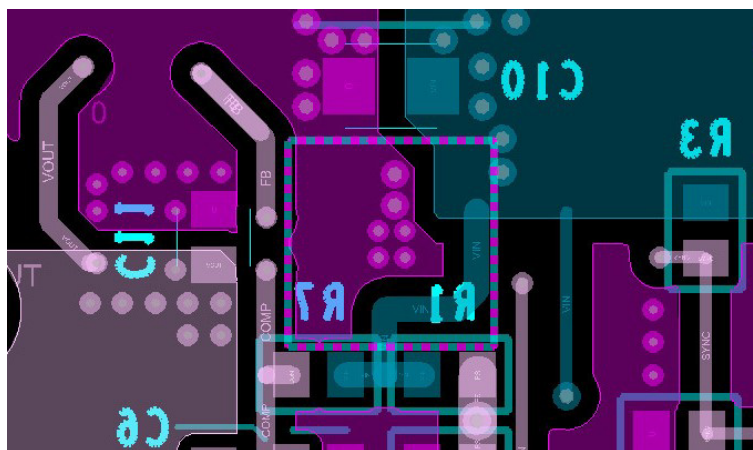

Figure 38. Layout Example - Bottom Layer

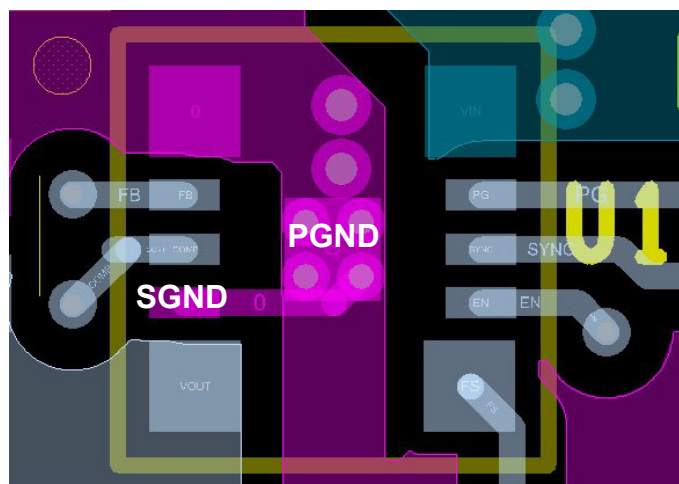

Figure 39. Layout Example - SGND is Connected to PGND at Single Point

7.2 Thermal Considerations

Experimental power loss curves, along with θ_{JA} from thermal modeling analysis, can evaluate the thermal consideration for the module. The derating curves are derived from the maximum power allowed while maintaining the temperature below the maximum junction temperature of +120°C. In applications in which the system parameters and layout are different from the evaluation board, the customer can adjust the margin of safety. All derating curves are obtained from tests on a 4-layer thermal test board 4.5x3 inches in size with 2oz copper on both top and bottom layers and 1oz copper on internal layers. See [TB379](#) for more details. In the actual application, other heat sources and design margins should be considered.

8. Package Description

The RAA210030 is integrated into a dual flat no-lead (DFN) package with exposed copper thermal pads. This package has such advantages as good thermal and electrical conductivity, low weight, and small size. The DFN package is applicable for surface mounting technology and is becoming more common in the industry. The embedded laminate substrate and inductor are overmolded with a polymer mold compound to protect these devices.

The package outline, typical PCB layout pattern, and typical stencil pattern design are shown in the [Package Outline Drawing](#). [TB493](#) shows the typical reflow profile parameters. These guidelines are general design rules. You can modify parameters according to your specific application.

8.1 PCB Layout Pattern Design

The bottom of RAA210030 is an embedded laminate substrate, which is attached to the PCB by surface mounting. The PCB layout pattern is in the Y10.3x3A [Package Outline Drawing](#). The PCB layout pattern is essentially 1:1 with the DFN package exposed pad and the I/O termination dimensions, except that the PCB lands are slightly longer than the dual flat no-lead (DFN) embedded laminate package terminations by about 0.3mm. This extension allows for solder filleting around the package periphery and ensures a more complete and inspectable solder joint. The thermal lands on the PCB layout should match 1:1 with the package exposed die pads.

8.2 Thermal Vias

Place a grid of 1.0mm to 1.2mm pitched thermal vias, which drops down and connects to buried copper planes under the thermal land. The vias should be about 0.3mm to 0.33mm in diameter, with the barrel plated to about 2.0 ounce copper. Although adding more vias (by decreasing pitch) improves thermal performance, it also diminishes results as more vias are added. Use only as many vias as needed for the thermal land size and as your board design rules allow.

8.3 Stencil Pattern Design

Reflowed solder joints on the perimeter I/O lands should have about a 50µm to 75µm (2 mil to 3 mil) standoff height. The solder paste stencil design is the first step in developing optimized, reliable solder joints. The stencil aperture size to land size ratio should typically be 1:1. Reduce the aperture width slightly to help prevent solder bridging between adjacent I/O lands.

Renesas recommends using an array of smaller apertures instead of one large aperture to reduce the solder paste volume on larger thermal lands. The stencil printing area should cover 50% to 80% of the PCB layout pattern. Consider the symmetry of the whole stencil pattern when designing the pads.

Renesas recommends using a laser-cut, stainless-steel stencil with electropolished trapezoidal walls. Electropolishing smooths the aperture walls, resulting in reduced surface friction and better paste release, which reduces voids. Using a Trapezoidal Section Aperture (TSA) also promotes paste release and forms a brick-like paste deposit, which assists in firm component placement.

8.4 Reflow Parameters

Renesas recommends using a No Clean Type 3 solder paste, per ANSI/J-STD-005 because of the low mount height of the DFN package. Nitrogen purge is also recommended during reflow. A system board reflow profile depends on the thermal mass of the entire populated board; therefore, it is not practical to define a specific soldering profile just for the DFN package. The profile given in [TB493](#) is provided as a guideline to customize for varying manufacturing practices and applications.

10. Ordering Information

Part Number ^{[1][2]}	Part Marking	Package Description (RoHS Compliant)	Pkg. Dwg. #	Carrier Type ^[3]	Junction Temperature
RAA210030GLG#HD0	0030	10 Ld 3x3 Dual Flat No-Leads Package	Y10.3X3A	Reel, 3k	-40 to +125
RTKA210030DR0000BU	Demonstration Board				

1. These Pb-free plastic packaged products are RoHS compliant by EU exemption 7C-I and 7A. They employ special Pb-free material sets; molding compounds/die attach materials and NiPdAu plate-e4 termination finish, which is compatible with both SnPb and Pb-free soldering operations. Pb-free products are MSL classified at Pb-free peak reflow temperatures that meet or exceed the Pb-free requirements of IPC/JEDEC J-STD-020.
2. For Moisture Sensitivity Level (MSL), see the [RAA210030](#) device page. For information about MSL, see [TB363](#).
3. See [TB347](#) for details about reel specifications.

11. Revision History

Revision	Date	Description
1.00	Jun 15, 2022	Initial release.

IMPORTANT NOTICE AND DISCLAIMER

RENESAS ELECTRONICS CORPORATION AND ITS SUBSIDIARIES (“RENESAS”) PROVIDES TECHNICAL SPECIFICATIONS AND RELIABILITY DATA (INCLUDING DATASHEETS), DESIGN RESOURCES (INCLUDING REFERENCE DESIGNS), APPLICATION OR OTHER DESIGN ADVICE, WEB TOOLS, SAFETY INFORMATION, AND OTHER RESOURCES “AS IS” AND WITH ALL FAULTS, AND DISCLAIMS ALL WARRANTIES, EXPRESS OR IMPLIED, INCLUDING, WITHOUT LIMITATION, ANY IMPLIED WARRANTIES OF MERCHANTABILITY, FITNESS FOR A PARTICULAR PURPOSE, OR NON-INFRINGEMENT OF THIRD PARTY INTELLECTUAL PROPERTY RIGHTS.

These resources are intended for developers skilled in the art designing with Renesas products. You are solely responsible for (1) selecting the appropriate products for your application, (2) designing, validating, and testing your application, and (3) ensuring your application meets applicable standards, and any other safety, security, or other requirements. These resources are subject to change without notice. Renesas grants you permission to use these resources only for development of an application that uses Renesas products. Other reproduction or use of these resources is strictly prohibited. No license is granted to any other Renesas intellectual property or to any third party intellectual property. Renesas disclaims responsibility for, and you will fully indemnify Renesas and its representatives against, any claims, damages, costs, losses, or liabilities arising out of your use of these resources. Renesas' products are provided only subject to Renesas' Terms and Conditions of Sale or other applicable terms agreed to in writing. No use of any Renesas resources expands or otherwise alters any applicable warranties or warranty disclaimers for these products.

(Rev.1.0 Mar 2020)

Corporate Headquarters

TOYOSU FORESIA, 3-2-24 Toyosu,
Koto-ku, Tokyo 135-0061, Japan
www.renesas.com

Contact Information

For further information on a product, technology, the most up-to-date version of a document, or your nearest sales office, please visit:
www.renesas.com/contact/

Trademarks

Renesas and the Renesas logo are trademarks of Renesas Electronics Corporation. All trademarks and registered trademarks are the property of their respective owners.