

Automotive Relays
CB RELAYS

Product Catalog

**IN Your
Future**

CB RELAYS

Mini-ISO Automotive Relay

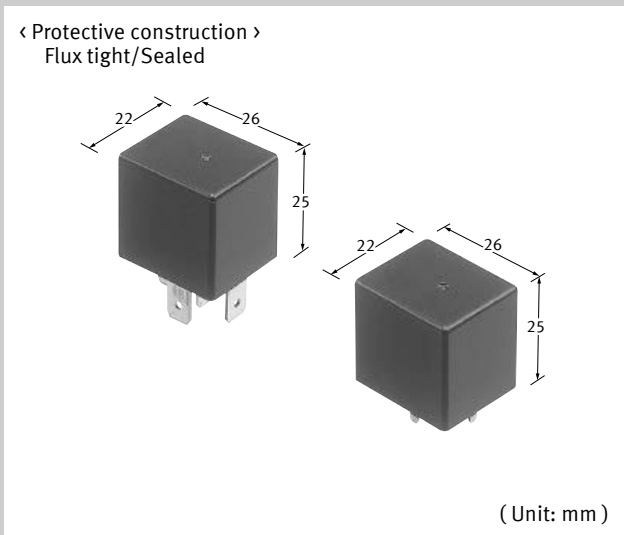

FEATURES

- This relay has an Mini-ISO (International Organization for Standardization) terminal arrangement.
- Compact and high capacity
- Features heat-resistant type
- Built-in resistor type is also available.

TYPICAL APPLICATIONS

- **Automobiles**
Cell motors, Air compressor, ABS, EPS, etc.
- **Construction equipment**
- **Agricultural equipment, Conveyor, etc.**

ORDERING INFORMATION (PART NO. : Ordering part number for Japanese market)

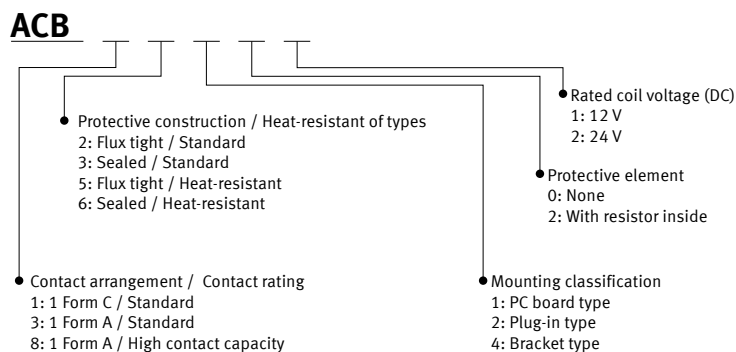

ORDERING INFORMATION (TYPE NO. : Ordering part number for non Japanese market)

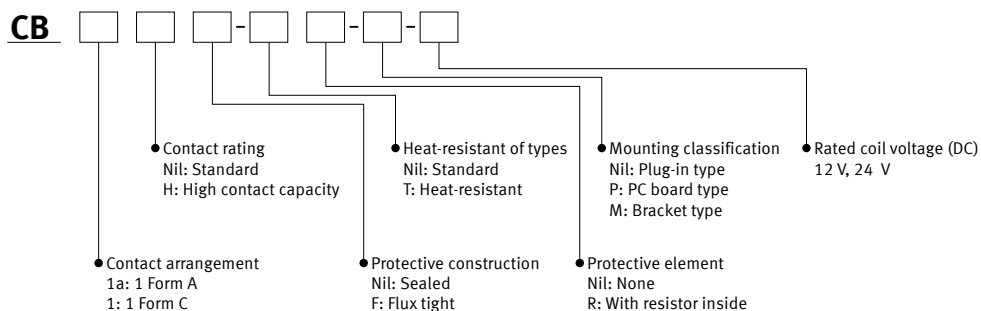

Automotive Relays CB RELAYS

TYPES

" Type No. " is ordering part number for non Japanese market. " Part No. " is ordering part number for Japanese market.

Contact arrangement	Mounting classification	Rated coil voltage	Standard type				High heat-resistant type				Packing	
			Sealed		Flux tight		Sealed		Flux tight		Carton	Case
			Type No.	Part No.	Type No.	Part No.	Type No.	Part No.	Type No.	Part No.		
1 Form A	PC board type	12 V DC	CB1a-P-12V	ACB33101	CB1aF-P-12V	ACB32101	CB1a-T-P-12V	ACB36101	CB1aF-T-P-12V	ACB35101	50 pcs.	200 pcs.
		24 V DC	CB1a-P-24V	ACB33102	CB1aF-P-24V	ACB32102	CB1a-T-P-24V	ACB36102	CB1aF-T-P-24V	ACB35102		
	Plug-in type	12 V DC	CB1a-12V	ACB33201	CB1aF-12V	ACB32201	CB1a-T-12V	ACB36201	CB1aF-T-12V	ACB35201		
		24 V DC	CB1a-24V	ACB33202	CB1aF-24V	ACB32202	CB1a-T-24V	ACB36202	CB1aF-T-24V	ACB35202		
	Bracket type	12 V DC	CB1a-M-12V	ACB33401	CB1aF-M-12V	ACB32401	CB1a-T-M-12V	ACB36401	CB1aF-T-M-12V	ACB35401		
		24 V DC	CB1a-M-24V	ACB33402	CB1aF-M-24V	ACB32402	CB1a-T-M-24V	ACB36402	CB1aF-T-M-24V	ACB35402		
1 Form C	PC board type	12 V DC	CB1-P-12V	ACB13101	CB1F-P-12V	ACB12101	CB1-T-P-12V	ACB16101	CB1F-T-P-12V	ACB15101		
		24 V DC	CB1-P-24V	ACB13102	CB1F-P-24V	ACB12102	CB1-T-P-24V	ACB16102	CB1F-T-P-24V	ACB15102		
	Plug-in type	12 V DC	CB1-12V	ACB13201	CB1F-12V	ACB12201	CB1-T-12V	ACB16201	CB1F-T-12V	ACB15201		
		24 V DC	CB1-24V	ACB13202	CB1F-24V	ACB12202	CB1-T-24V	ACB16202	CB1F-T-24V	ACB15202		
	Bracket type	12 V DC	CB1-M-12V	ACB13401	CB1F-M-12V	ACB12401	CB1-T-M-12V	ACB16401	CB1F-T-M-12V	ACB15401		
		24 V DC	CB1-M-24V	ACB13402	CB1F-M-24V	ACB12402	CB1-T-M-24V	ACB16402	CB1F-T-M-24V	ACB15402		
1 Form A High contact capacity	PC board type	12 V DC	CB1aH-P-12V	ACB83101	CB1aHF-P-12V	ACB82101	CB1aH-T-P-12V	ACB86101	CB1aHF-T-P-12V	ACB85101		
		24 V DC	CB1aH-P-24V	ACB83102	CB1aHF-P-24V	ACB82102	CB1aH-T-P-24V	ACB86102	CB1aHF-T-P-24V	ACB85102		
	Plug-in type	12 V DC	CB1aH-12V	ACB83201	CB1aHF-12V	ACB82201	CB1aH-T-12V	ACB86201	CB1aHF-T-12V	ACB85201		
		24 V DC	CB1aH-24V	ACB83202	CB1aHF-24V	ACB82202	CB1aH-T-24V	ACB86202	CB1aHF-T-24V	ACB85202		
	Bracket type	12 V DC	CB1aH-M-12V	ACB83401	CB1aHF-M-12V	ACB82401	CB1aH-T-M-12V	ACB86401	CB1aHF-T-M-12V	ACB85401		
		24 V DC	CB1aH-M-24V	ACB83402	CB1aHF-M-24V	ACB82402	CB1aH-T-M-24V	ACB86402	CB1aHF-T-M-24V	ACB85402		

Note: Please use "CB**R**" to order with resistor inside type. (Asterisks "*" should be filled in from ORDERING INFORMATION.)

RATING

Coil data

1) No protective element

Contact arrangement Contact rating	Rated coil voltage	Operate voltage (at 20°C)(Initial)	Release voltage (at 20°C)(Initial)	Rated operating current [±10%] (at 20°C)	Coil resistance [±10%] (at 20°C)	Rated operating power (at 20°C)	Usable voltage range
1 Form A, 1 Form C	12 V DC	3 to 7 V DC	1.2 to 4.2 V DC	117 mA	103 Ω	1.4 W	10 to 16 V DC
	24 V DC	6 to 14 V DC	2.4 to 8.4 V DC	75 mA	320 Ω	1.8 W	20 to 32 V DC
1 Form A High contact capacity	12 V DC	3 to 7 V DC	1.2 to 4.2 V DC	117 mA	103 Ω	1.4 W (PC board type)	10 to 16 V DC
				150 mA	80 Ω	1.8 W	
	24 V DC	6 to 14 V DC	2.4 to 8.4 V DC	58 mA	411 Ω	1.4 W (PC board type)	20 to 32 V DC
				75 mA	320 Ω	1.8 W	

Note: Other operate voltage types are also available. Please inquire our sales representative for details.

2) With resistor inside

Contact arrangement	Rated coil voltage	Operate voltage (at 20°C)(Initial)	Release voltage (at 20°C)(Initial)	Rated operating current [±10%] (at 20°C)	Equivalent coil resistance [±10%] (at 20°C)	Rated operating power (at 20°C)	Usable voltage range
1 Form A, 1 Form C	12 V DC	3 to 7 V DC	1.2 to 4.2 V DC	134 mA	89.5 Ω	1.6 W	10 to 16 V DC
	24 V DC	6 to 14 V DC	2.4 to 8.4 V DC	84 mA	287.2 Ω	2.0 W	20 to 32 V DC
1 Form A High contact capacity	12 V DC	3 to 7 V DC	1.2 to 4.2 V DC	134 mA	89.5 Ω	1.6 W (PC board type)	10 to 16 V DC
				168 mA	71.6 Ω	2.0 W	
	24 V DC	6 to 14 V DC	2.4 to 8.4 V DC	67 mA	358 Ω	1.6 W (PC board type)	20 to 32 V DC
				84 mA	287.2 Ω	2.0 W	

■ Specifications

1) Standard type (12 V coil voltage)

Item		Specifications		
Contact data	Contact arrangement	1 Form A	1 Form C	1 Form A High contact capacity
	Contact resistance (initial)	Max. 15 mΩ (Typ. 2 mΩ) (by voltage drop 1 A 6 V DC)		
	Contact material	Ag alloy		
	Rated switching capacity (resistive)	40 A 14 V DC	N.O. side: 40 A 14 V DC N.C. side: 30 A 14 V DC	70 A 14 V DC (at 20°C) 50 A 14 V DC (at 85°C)
	Max. carrying current* ¹ (coil applied voltage 14 V DC, at 85°C, continuous)	N.O. side: 40 A	N.O. side: 40 A N.C. side: 30 A	N.O. side: 40 A
	Min. switching load (resistive)* ²	1 A 14 V DC (at 20°C)		
Insulated resistance (initial)		Min. 20 MΩ (at 500 V DC, Measurement at same location as "Dielectric strength" section.)		
Dielectric strength (initial)	Between open contacts	500 Vrms for 1 min (Detection current: 10 mA)		
	Between contacts and coil	500 Vrms for 1 min (Detection current: 10 mA)		
Time characteristics (initial)	Operate time (at rated voltage)	Max. 15 ms (at 20°C, without contact bounce time)	Max. 15 ms (at 20°C, without contact bounce time)	Max. 15 ms (at 20°C, without contact bounce time)
	Release time (at rated voltage)	Max. 15 ms (at 20°C) (without diode)	Max. 15 ms (at 20°C, without contact bounce time) (without diode)	Max. 15 ms (at 20°C) (without diode)
Shock resistance	Functional	Min. 200 m/s ² (Half-wave pulse of sine wave: 11 ms, detection time: 10 μs)		
	Destructive	Min. 1,000 m/s ² (Half-wave pulse of sine wave: 6 ms)		
Vibration resistance	Functional	10 to 500 Hz, Min. 44.1 m/s ² (Detection time: 10 μs)		
	Destructive	10 to 2,000 Hz, Min. 44.1 m/s ² (Time of vibration for each direction; X, Y, Z direction: 4 hours)		
Expected life	Mechanical	Min. 10 ⁶ (at 120 times/min)		
	Electrical (at rated switching capacity)	Flux tight: Min. 10 ⁵ , Sealed: Min. 5 x 10 ⁴ (operating frequency: 2 s ON, 2 s OFF)		
Conditions	Conditions for usage, transport and storage* ³	Standard: Ambient temperature: -40 to +85°C, Humidity: 5 to 85% RH (Avoid icing and condensation)		
		Heat-resistant: Ambient temperature: -40 to +125°C, Humidity: 2 to 85% RH (Avoid icing and condensation)		
Weight		Approx. 33 g		

Notes: *1. Depends on connection conditions. Also, this does not guarantee repeated switching. We recommend that you confirm operation under actual conditions.

*2. This value can change due to the switching frequency, environmental conditions, and desired reliability level, therefore it is recommended to check this with the actual load.

*3. The upper operation ambient temperature limit is the maximum temperature that can satisfy the coil temperature rise value. For details, please refer to the "Automotive Relay Users Guide".

Please inquire our sales representative if you will be using the relay in a high temperature atmosphere (110°C).

2) Standard type (24 V coil voltage)

Item		Specifications		
Contact data	Contact arrangement	1 Form A	1 Form C	1 Form A High contact capacity
	Contact resistance (initial)	Max. 15 mΩ (by voltage drop 1 A 6 V DC)		
	Contact material	Ag alloy		
	Rated switching capacity (resistive)	20 A 28 V DC	N.O. side: 20 A 28 V DC N.C. side: 10 A 28 V DC	20 A 28 V DC
	Max. carrying current (coil applied voltage 28 V DC, at 85°C, continuous)	20 A	N.O. side: 20 A N.C. side: 10 A	20 A

Note: All other specifications are the same as those of standard type (12 V coil voltage).

Automotive Relays CB RELAYS

3) Heat-resistant type (12 V and 24 v coil voltage)

Item	Specifications					
	12 V			24 V		
Contact arrangement	1 Form A	1 Form C	1 Form A High contact capacity	1 Form A	1 Form C	1 Form A High contact capacity
Contact resistance (initial)	Max. 15 mΩ (by voltage drop 1 A 6 V DC)					
Contact material	Ag alloy					
Rated switching capacity (resistive)	40 A 14 V DC	N.O. side: 40 A 14 V DC N.C. side: 30 A 14 V DC	70 A 14 V DC	20 A 28 V DC	N.O. side: 20 A 28 V DC N.C. side: 10 A 28 V DC	20 A 28 V DC
Max. carrying current (at coil applied voltage, at 125°C, continuous)*	50 A 14 V DC	N.O. side: 50 A 14 V DC N.C. side: 30 A 14 V DC	45 A 14 V DC* 50 A 14 V DC*	25 A 28 V DC	N.O. side: 25 A 28 V DC N.C. side: 10 A 28 V DC	25 A 28 V DC*

Notes: 1.All other specifications are the same as those of standard (12 V coil voltage).
2.*Conditions: at coil applied voltage, at 85°C, continuous

REFERENCE DATA

CB Relays (Standard)

1.Allowable ambient temperature

(Heat-resistant and standard)

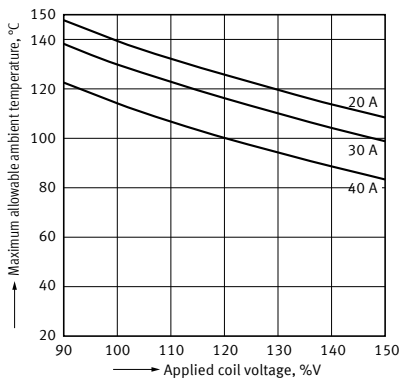

Notes:
• Maximum mean coil temperature: 180°C
• Curves are based on 1.4 W (Nominal power consumption of the unsuppressed coil at nominal voltage)

2.Max. switching capability (Resistive)

(Standard)

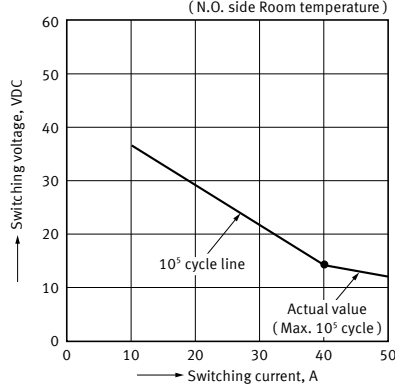

3.Ambient temperature and usable voltage range

(Standard)

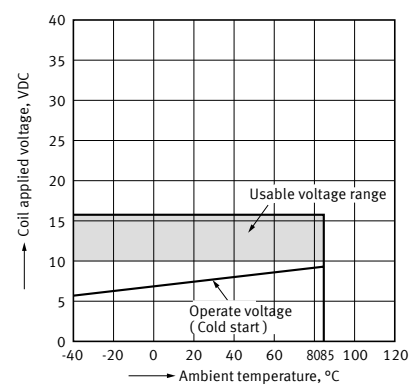

4.Distribution of operate and release voltage 5.Distribution of operate and release time

Sample: CB1-P-12V, 42 pcs.

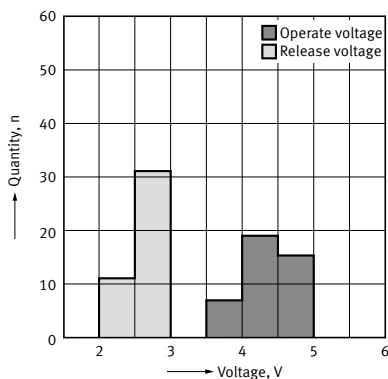

Sample: CB1-P-12V, 42 pcs.

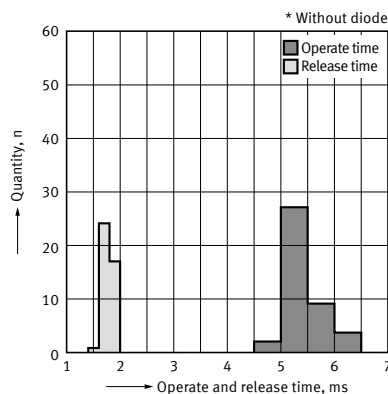

6. Electrical life test (Motor free)

Sample: CB1F-12V, 5 pcs.
 Load: 25 A 14 V DC, motor free actual load
 Operating frequency: ON 1 s, OFF 9 s
 Ambient temperature: Room temperature
 Circuit:

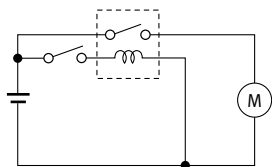

Change of operate and release voltage

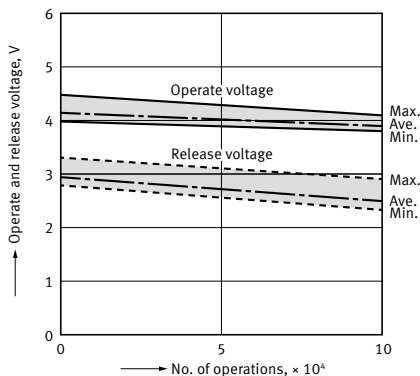

Change of contact resistance

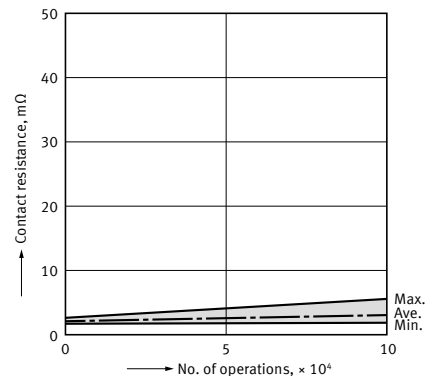

Load current waveform
 Load; Inrush current: 80 A, Steady current: 25 A

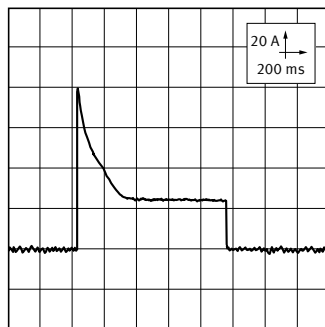

■ CB Relays (High contact capacity)

1. Allowable ambient temperature

(Heat-resistant and high contact capacity)

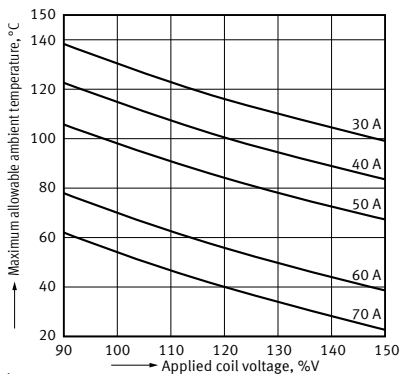

Notes:
 • Maximum mean coil temperature: 180°C
 • Curves are based on 1.4 W (Nominal power consumption of the unsuppressed coil at nominal voltage)

2. Ambient temperature and usable voltage range

(High contact capacity and standard)

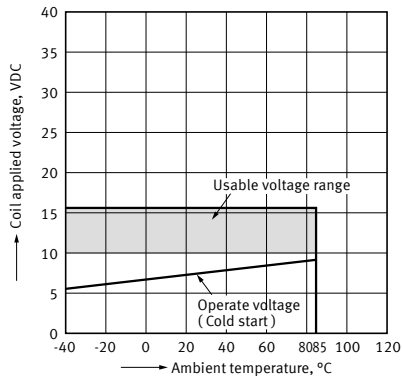

3. Distribution of operate and release voltage

Sample: CB1aHF-12V, 53 pcs.

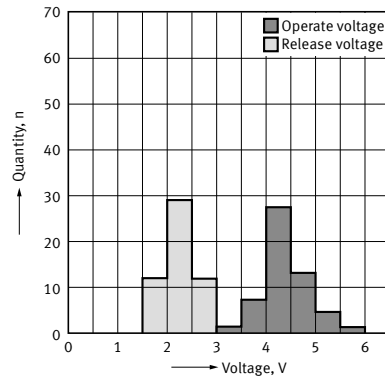

Automotive Relays CB RELAYS

4. Distribution of operate and release time

Sample: CB1aHF-12V, 53 pcs.

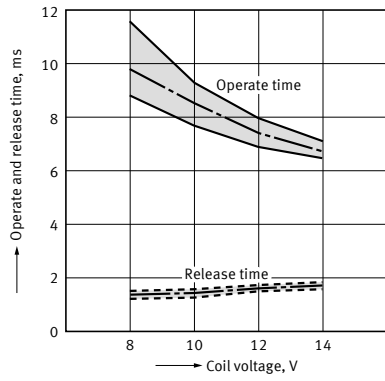

5. Contact resistance

Sample: CB1aHF-12 V, 53 pcs.
(By voltage drop 1 A 6 V DC)

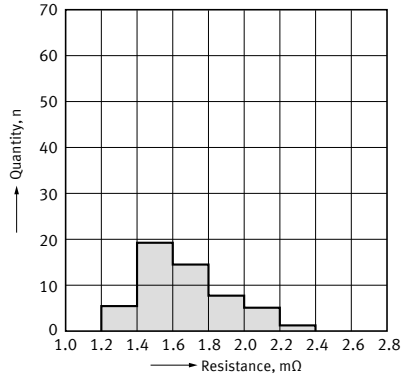

6. Electrical life test (Motor free)

Sample: CB1aH-12V, 3 pcs.
Load: Inrush current: 64 A, Steady current: 35 A
Fan motor actual load (motor free) 12 V DC
Operating frequency: ON 3 s, OFF 7 s
Ambient temperature: Room temperature
Circuit:

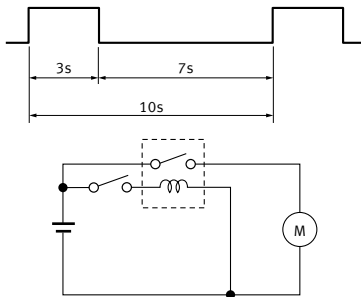

Change of operate and release voltage

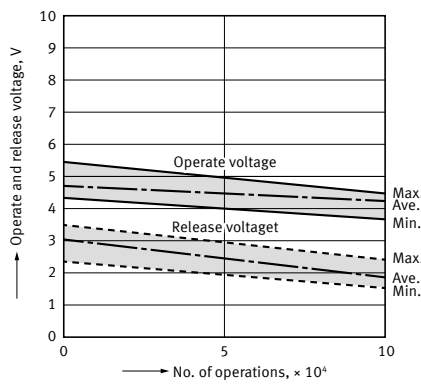

Change of contact resistance

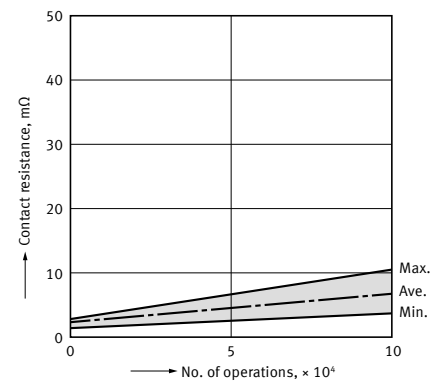

Load current waveform

Load; Inrush current: 64 A, Steady current: 35 A

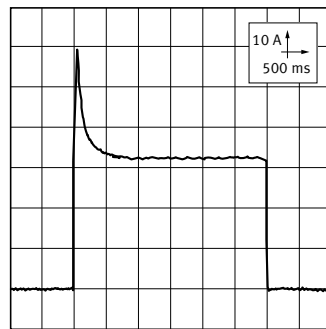

DIMENSIONS

CAD The CAD data of the products with a "CAD" mark can be downloaded from our Website.

Unit: mm

PC board type

CAD



External dimensions

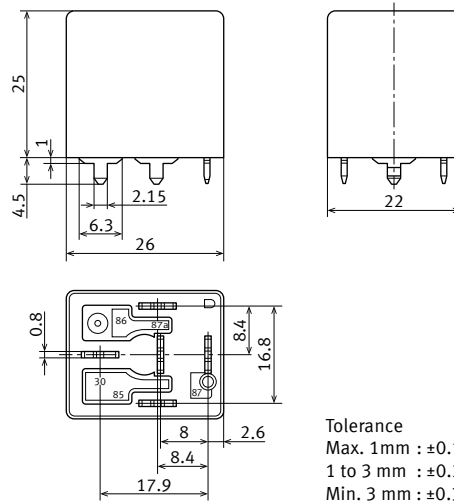

Tolerance
 Max. 1mm : ±0.1
 1 to 3 mm : ±0.2
 Min. 3 mm : ±0.3

Schematic
(BOTTOM VIEW)

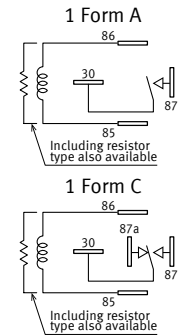

PC board pattern
(BOTTOM VIEW)

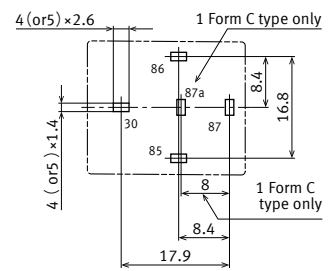

Tolerance: ± 0.1

Plug-in type

CAD



External dimensions

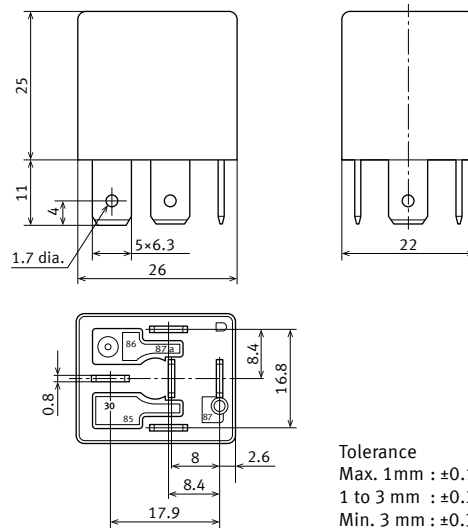

Tolerance
 Max. 1mm : ±0.1
 1 to 3 mm : ±0.2
 Min. 3 mm : ±0.3

Schematic
(BOTTOM VIEW)

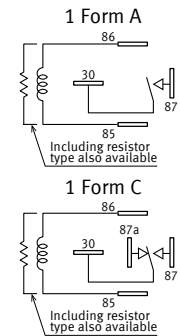

Automotive Relays CB RELAYS

Bracket type

CAD



External dimensions

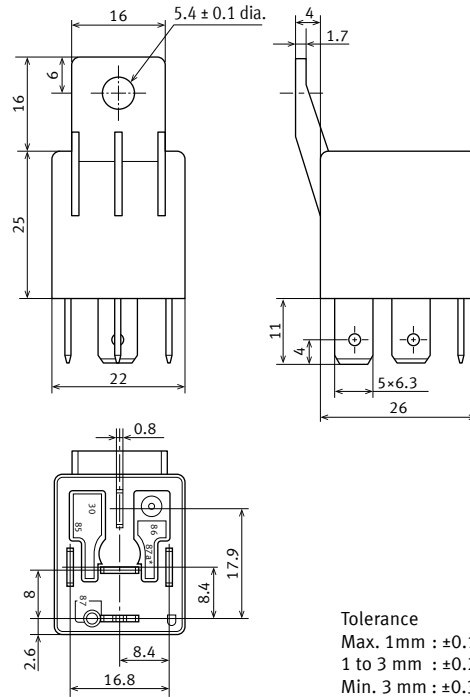

Tolerance
 Max. 1mm : ±0.1
 1 to 3 mm : ±0.2
 Min. 3 mm : ±0.3

Schematic
(BOTTOM VIEW)

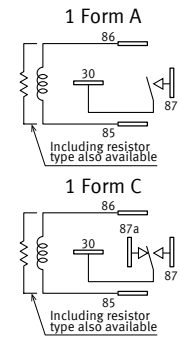

1 Form A high contact capacity (Plug-in type)

CAD



External dimensions

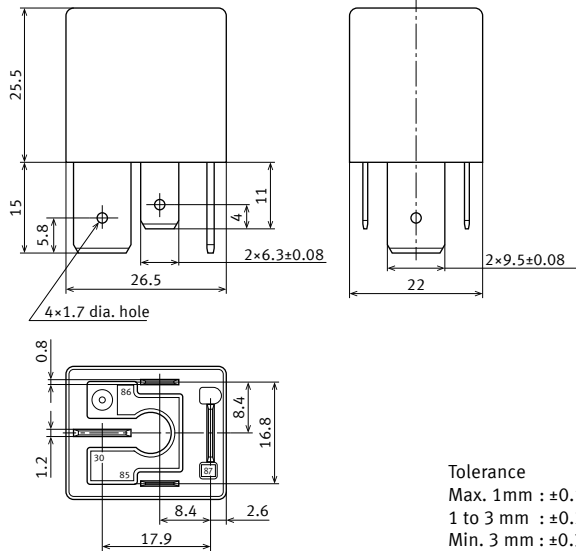

Tolerance
 Max. 1mm : ±0.1
 1 to 3 mm : ±0.2
 Min. 3 mm : ±0.3

Schematic
(BOTTOM VIEW)

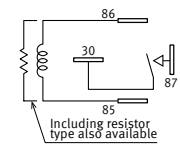

■ 1 Form A high contact capacity (PC board type)

CAD



External dimensions

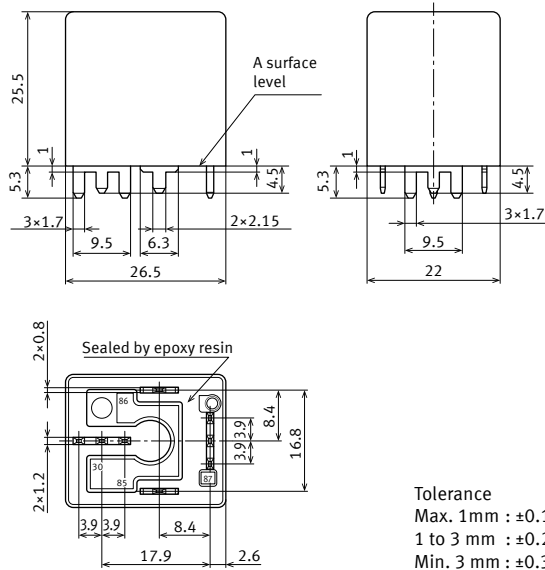

Schematic (BOTTOM VIEW)

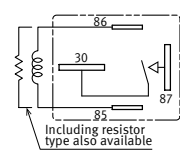

PC board pattern (BOTTOM VIEW)

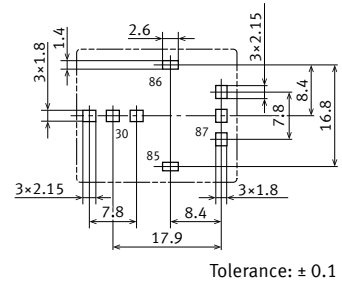

Tolerance
 Max. 1mm : ±0.1
 1 to 3 mm : ±0.2
 Min. 3 mm : ±0.3

* Intervals between terminals is measured at A surface level.

GUIDELINES FOR USAGE

■ For general cautions for use, please refer to the "Automotive Relay Users Guide".

■ Precautions when using CB relays

● Soldering

Solder temperature: 350°C, within 3 sec (in a solder bath)
 The effect on the relay depends on the actual PC board used.
 Please verify the PC board to be used.

● Usage, transport and storage conditions

1) Ambient temperature, humidity, and air pressure during usage, transport of the relay

- (1) Temperature: -40 to +85°C (Standard type)
 -40 to +125°C (High heat-resistant type)
 - (2) Humidity: 2 to 85% RH (Avoid icing and condensation)
 - (3) Air pressure: 86 to 106 kPa
- The humidity range varies with the temperature. Use within the range indicated in the graph.

[Temperature and humidity range for usage, transport, and storage]

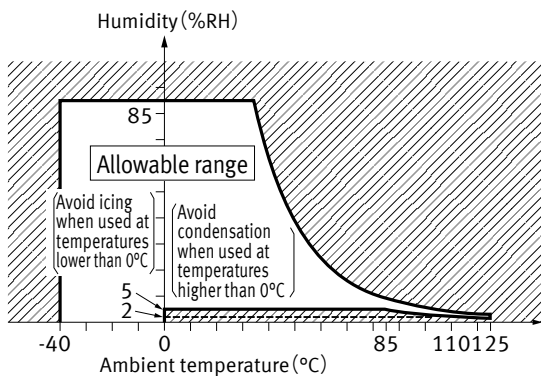

Please refer to "the latest product specifications" when designing your product.
 •Requests to customers:
<https://industrial.panasonic.com/ac/e/salespolicies/>

Panasonic
INDUSTRY

Panasonic Industry Co., Ltd.

Electromechanical Control Business Division
■1006, Oaza Kadoma, Kadoma-shi, Osaka 571-8506, Japan
industrial.panasonic.com/ac/e/