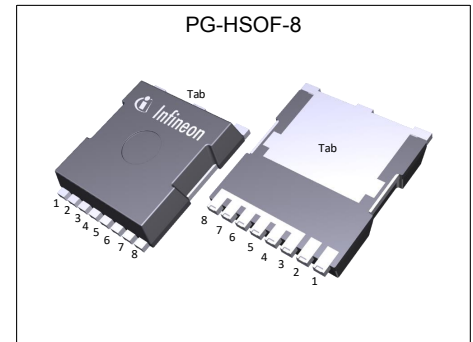


## MOSFET

### 650V CoolMOS™ CFD7 SJ Power Device

The latest 650 V CoolMOS™ CFD7 extends the voltage class offering of the CFD7 family and is a successor to the 650 V CoolMOS™ CFD2. Resulting from improved switching performance and excellent thermal behavior, 650 V CoolMOS™ CFD7 offers highest efficiency in resonant switching topologies, such as LLC and phase-shift-full-bridge (ZVS). As part of Infineon's fast body diode portfolio, this new product series blends all advantages of a fast switching technology together with superior hard commutation robustness. The CoolMOS™ CFD7 technology meets highest efficiency and reliability standards and furthermore supports high power density solutions.



### Features

- Ultra-fast body diode
- 650V break down voltage
- Best-in-class  $R_{DS(on)}$
- Reduced switching losses
- Low  $R_{DS(on)}$  dependency over temperature

### Benefits

- Excellent hard commutation ruggedness
- Extra safety margin for designs with increased bus voltage
- Enabling increased power density solutions
- Outstanding light load efficiency in industrial SMPS applications
- Improved full load efficiency in industrial SMPS applications

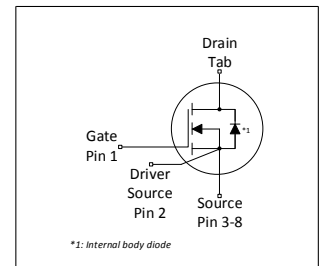
### Potential applications

Optimized for phase-shift full-bridge (ZVS), LLC Applications – Server, Telecom, EV Charging, Solar

### Product validation

Fully qualified according to JEDEC for Industrial Applications

*Please note: The source and sense source pins are not exchangeable. Their exchange might lead to malfunction. For paralleling 4pin MOSFET devices the placement of the gate resistor is generally recommended to be on the Driver Source instead of the Gate.*



RoHS

**Table 1 Key Performance Parameters**

Parameter	Value	Unit
$V_{DS} @ T_{j,max}$	700	V
$R_{DS(on),max}$	40	m $\Omega$
$Q_{g,typ}$	97	nC
$I_{D,pulse}$	211	A
$E_{oss} @ 400V$	14.8	$\mu$ J
Body diode $di_F/dt$	1300	A/ $\mu$ s

Type / Ordering Code	Package	Marking	Related Links
IPT65R040CFD7	PG-HSOF-8	65R040F7	see Appendix A

## Table of Contents

Description .....	1
Maximum ratings .....	3
Thermal characteristics .....	4
Electrical characteristics .....	5
Electrical characteristics diagrams .....	7
Test Circuits .....	11
Package Outlines .....	12
Appendix A .....	13
Revision History .....	14
Trademarks .....	14
Disclaimer .....	14

## 1 Maximum ratings

at  $T_j = 25^\circ\text{C}$ , unless otherwise specified

**Table 2 Maximum ratings**

Parameter	Symbol	Values			Unit	Note / Test Condition
		Min.	Typ.	Max.		
Continuous drain current <sup>1)</sup>	$I_D$	-	-	63 40	A	$T_C=25^\circ\text{C}$ $T_C=100^\circ\text{C}$
Pulsed drain current <sup>2)</sup>	$I_{D,pulse}$	-	-	211	A	$T_C=25^\circ\text{C}$
Avalanche energy, single pulse	$E_{AS}$	-	-	248	mJ	$I_D=6.4\text{A}$ ; $V_{DD}=50\text{V}$ ; see table 10
Avalanche energy, repetitive	$E_{AR}$	-	-	1.24	mJ	$I_D=6.4\text{A}$ ; $V_{DD}=50\text{V}$ ; see table 10
Avalanche current, single pulse	$I_{AS}$	-	-	6.4	A	-
MOSFET dv/dt ruggedness	dv/dt	-	-	120	V/ns	$V_{DS}=0\dots400\text{V}$
Gate source voltage (static)	$V_{GS}$	-20	-	20	V	static;
Gate source voltage (dynamic)	$V_{GS}$	-30	-	30	V	AC ( $f>1\text{ Hz}$ )
Power dissipation	$P_{tot}$	-	-	347	W	$T_C=25^\circ\text{C}$
Storage temperature	$T_{stg}$	-55	-	150	$^\circ\text{C}$	-
Operating junction temperature	$T_j$	-55	-	150	$^\circ\text{C}$	-
Mounting torque	-	-	-	n.a.	Ncm	-
Continuous diode forward current <sup>1)</sup>	$I_S$	-	-	63	A	$T_C=25^\circ\text{C}$
Diode pulse current <sup>2)</sup>	$I_{S,pulse}$	-	-	211	A	$T_C=25^\circ\text{C}$
Reverse diode dv/dt <sup>3)</sup>	dv/dt	-	-	70	V/ns	$V_{DS}=0\dots400\text{V}$ , $I_{SD}\leq 24.8\text{A}$ , $T_j=25^\circ\text{C}$ see table 8
Maximum diode commutation speed	di <sub>F</sub> /dt	-	-	1300	A/ $\mu\text{s}$	$V_{DS}=0\dots400\text{V}$ , $I_{SD}\leq 24.8\text{A}$ , $T_j=25^\circ\text{C}$ see table 8
Insulation withstand voltage	$V_{ISO}$	-	-	n.a.	V	$V_{rms}$ , $T_C=25^\circ\text{C}$ , $t=1\text{min}$

<sup>1)</sup> Limited by  $T_{j,max}$ .

<sup>2)</sup> Pulse width  $t_p$  limited by  $T_{j,max}$

<sup>3)</sup> Identical low side and high side switch with identical  $R_\theta$

## 2 Thermal characteristics

**Table 3 Thermal characteristics**

Parameter	Symbol	Values			Unit	Note / Test Condition
		Min.	Typ.	Max.		
Thermal resistance, junction - case	$R_{thJC}$	-	-	0.36	°C/W	-
Thermal resistance, junction - ambient	$R_{thJA}$	-	-	62	°C/W	device on PCB, minimal footprint
Thermal resistance, junction - ambient for SMD version	$R_{thJA}$	-	35	45	°C/W	Device on 40mm*40mm*1.5mm epoxy PCB FR4 with 6cm <sup>2</sup> (one layer, 70µm thickness) copper area for drain connection and cooling. PCB is vertical without air stream cooling.
Soldering temperature, wave- & reflow soldering allowed	$T_{sold}$	-	-	260	°C	reflow MSL1

### 3 Electrical characteristics

at  $T_j=25^\circ\text{C}$ , unless otherwise specified

**Table 4 Static characteristics**

Parameter	Symbol	Values			Unit	Note / Test Condition
		Min.	Typ.	Max.		
Drain-source breakdown voltage	$V_{(BR)DSS}$	650	-	-	V	$V_{GS}=0V, I_D=1mA$
Gate threshold voltage	$V_{(GS)th}$	3.5	4	4.5	V	$V_{DS}=V_{GS}, I_D=1.24mA$
Zero gate voltage drain current <sup>1)</sup>	$I_{DSS}$	-	-	1	$\mu A$	$V_{DS}=650V, V_{GS}=0V, T_j=25^\circ C$ $V_{DS}=650V, V_{GS}=0V, T_j=125^\circ C$
Gate-source leakage current	$I_{GSS}$	-	-	100	nA	$V_{GS}=20V, V_{DS}=0V$
Drain-source on-state resistance	$R_{DS(on)}$	-	0.034	0.040	$\Omega$	$V_{GS}=10V, I_D=24.8A, T_j=25^\circ C$ $V_{GS}=10V, I_D=24.8A, T_j=150^\circ C$
Gate resistance	$R_G$	-	3.8	-	$\Omega$	$f=1MHz, \text{open drain}$

**Table 5 Dynamic characteristics**

Parameter	Symbol	Values			Unit	Note / Test Condition
		Min.	Typ.	Max.		
Input capacitance	$C_{iss}$	-	4975	-	pF	$V_{GS}=0V, V_{DS}=400V, f=250kHz$
Output capacitance	$C_{oss}$	-	75	-	pF	$V_{GS}=0V, V_{DS}=400V, f=250kHz$
Effective output capacitance, energy related <sup>2)</sup>	$C_{o(er)}$	-	185	-	pF	$V_{GS}=0V, V_{DS}=0...400V$
Effective output capacitance, time related <sup>3)</sup>	$C_{o(tr)}$	-	1957	-	pF	$I_D=\text{constant}, V_{GS}=0V, V_{DS}=0...400V$
Turn-on delay time	$t_{d(on)}$	-	34	-	ns	$V_{DD}=400V, V_{GS}=13V, I_D=24.8A,$ $R_G=3.3\Omega; \text{see table 9}$
Rise time	$t_r$	-	10	-	ns	$V_{DD}=400V, V_{GS}=13V, I_D=24.8A,$ $R_G=3.3\Omega; \text{see table 9}$
Turn-off delay time	$t_{d(off)}$	-	115	-	ns	$V_{DD}=400V, V_{GS}=13V, I_D=24.8A,$ $R_G=3.3\Omega; \text{see table 9}$
Fall time	$t_f$	-	3	-	ns	$V_{DD}=400V, V_{GS}=13V, I_D=24.8A,$ $R_G=3.3\Omega; \text{see table 9}$

**Table 6 Gate charge characteristics**

Parameter	Symbol	Values			Unit	Note / Test Condition
		Min.	Typ.	Max.		
Gate to source charge	$Q_{gs}$	-	29	-	nC	$V_{DD}=400V, I_D=24.8A, V_{GS}=0 \text{ to } 10V$
Gate to drain charge	$Q_{gd}$	-	29	-	nC	$V_{DD}=400V, I_D=24.8A, V_{GS}=0 \text{ to } 10V$
Gate charge total	$Q_g$	-	97	-	nC	$V_{DD}=400V, I_D=24.8A, V_{GS}=0 \text{ to } 10V$
Gate plateau voltage	$V_{plateau}$	-	5.7	-	V	$V_{DD}=400V, I_D=24.8A, V_{GS}=0 \text{ to } 10V$

<sup>1)</sup> Maximum specification is defined by calculated six sigma upper confidence bound

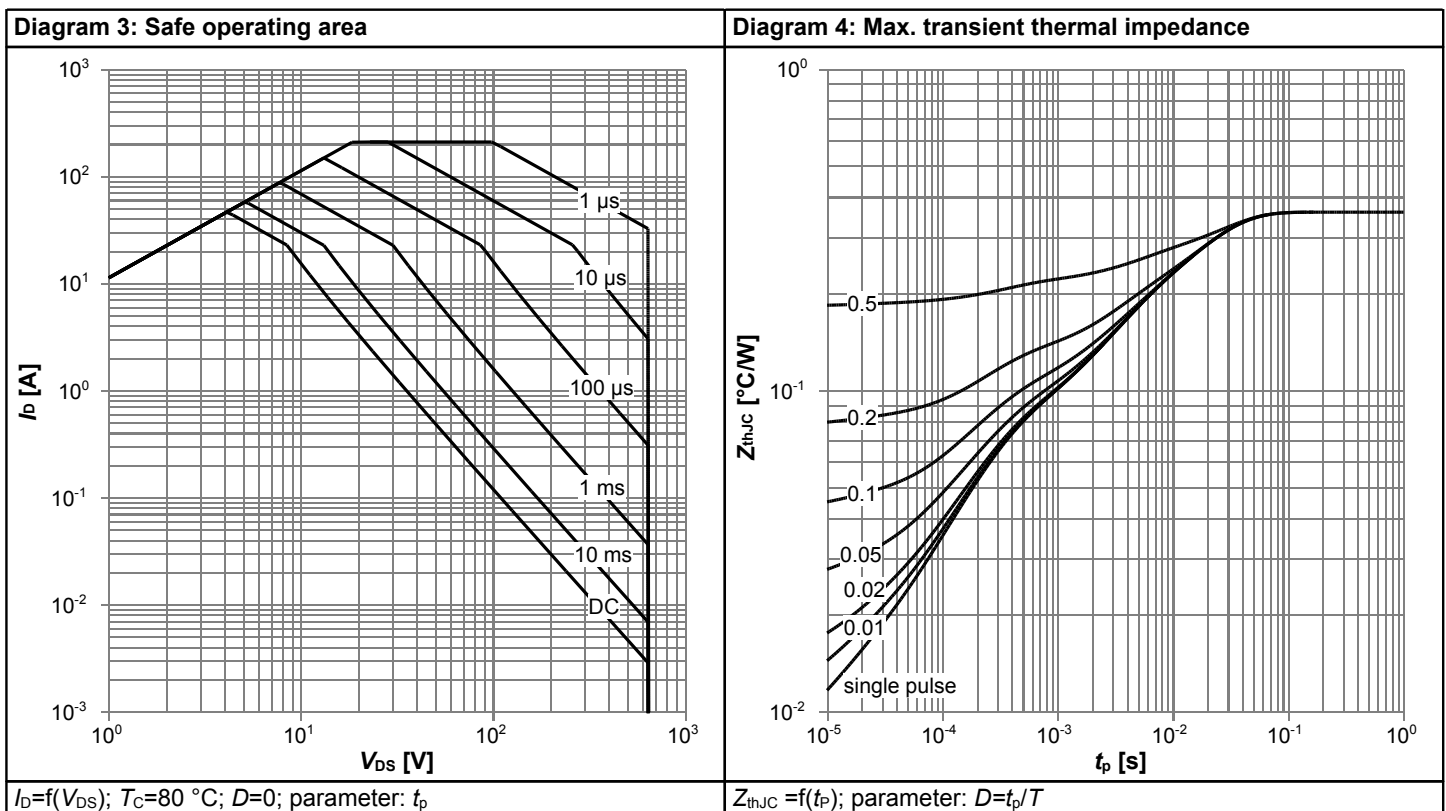
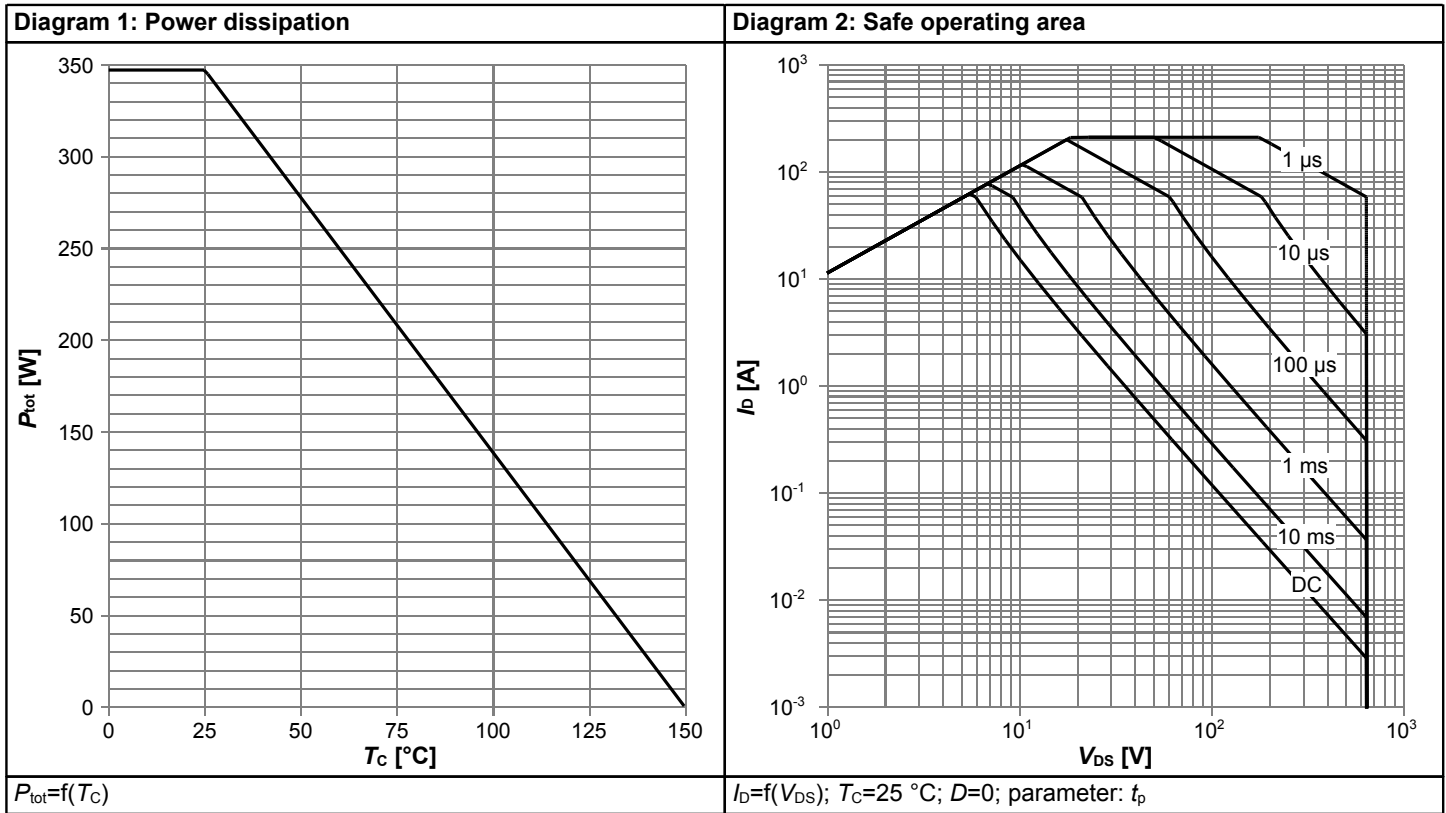
<sup>2)</sup>  $C_{o(er)}$  is a fixed capacitance that gives the same stored energy as  $C_{oss}$  while  $V_{DS}$  is rising from 0 to 400V

<sup>3)</sup>  $C_{o(tr)}$  is a fixed capacitance that gives the same charging time as  $C_{oss}$  while  $V_{DS}$  is rising from 0 to 400V

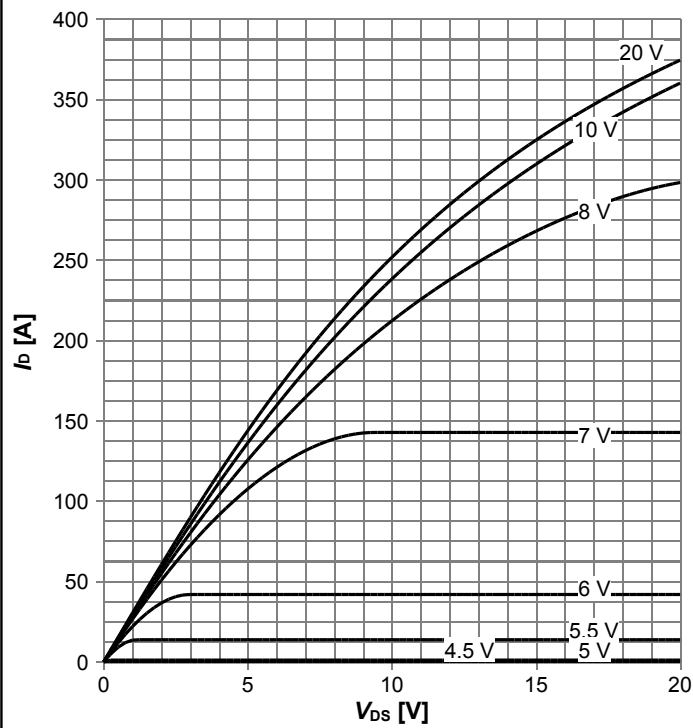
**Table 7 Reverse diode characteristics**

Parameter	Symbol	Values			Unit	Note / Test Condition
		Min.	Typ.	Max.		
Diode forward voltage	$V_{SD}$	-	1.0	-	V	$V_{GS}=0V, I_F=24.8A, T_j=25^{\circ}C$
Reverse recovery time	$t_{rr}$	-	180	270	ns	$V_R=400V, I_F=24.8A, di_F/dt=100A/\mu s$ ; see table 8
Reverse recovery charge	$Q_{rr}$	-	1.3	2.6	$\mu C$	$V_R=400V, I_F=24.8A, di_F/dt=100A/\mu s$ ; see table 8
Peak reverse recovery current	$I_{rrm}$	-	11.8	-	A	$V_R=400V, I_F=24.8A, di_F/dt=100A/\mu s$ ; see table 8

### 4 Electrical characteristics diagrams

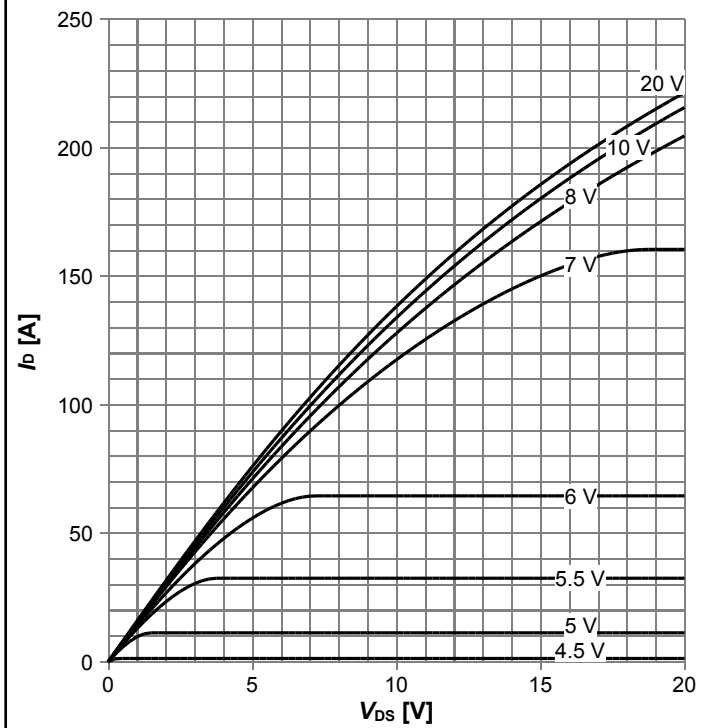


**Diagram 5: Typ. output characteristics**



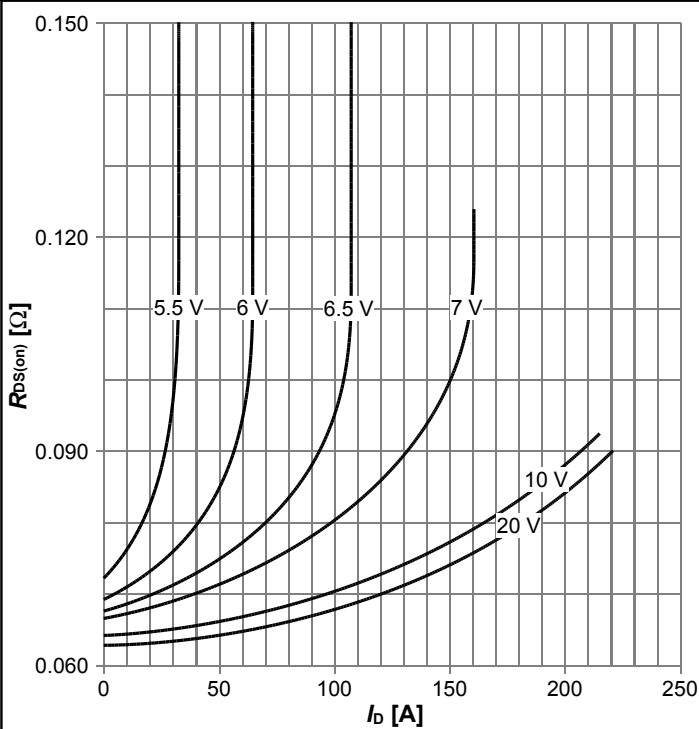
$I_D=f(V_{DS}); T_j=25\text{ °C}; \text{parameter: } V_{GS}$

**Diagram 6: Typ. output characteristics**



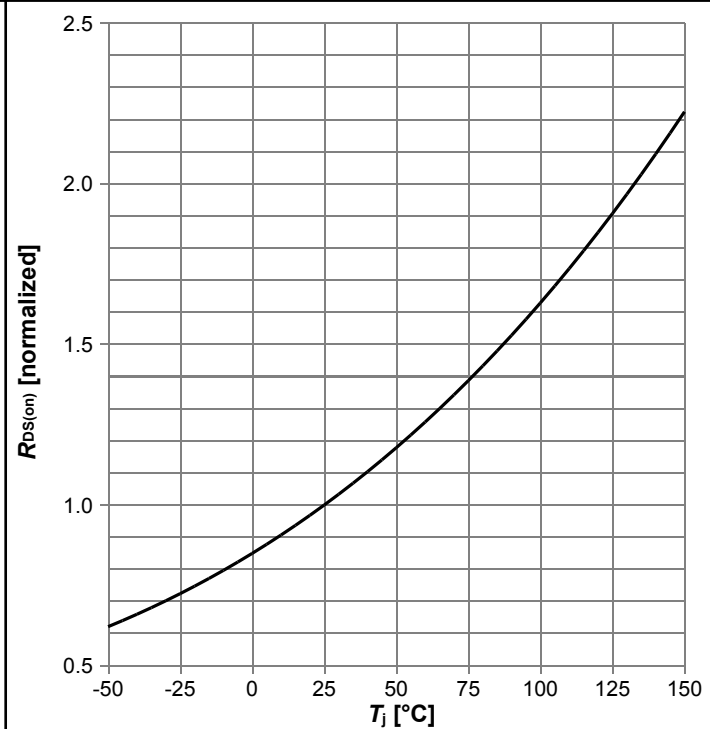
$I_D=f(V_{DS}); T_j=125\text{ °C}; \text{parameter: } V_{GS}$

**Diagram 7: Typ. drain-source on-state resistance**



$R_{DS(on)}=f(I_D); T_j=125\text{ °C}; \text{parameter: } V_{GS}$

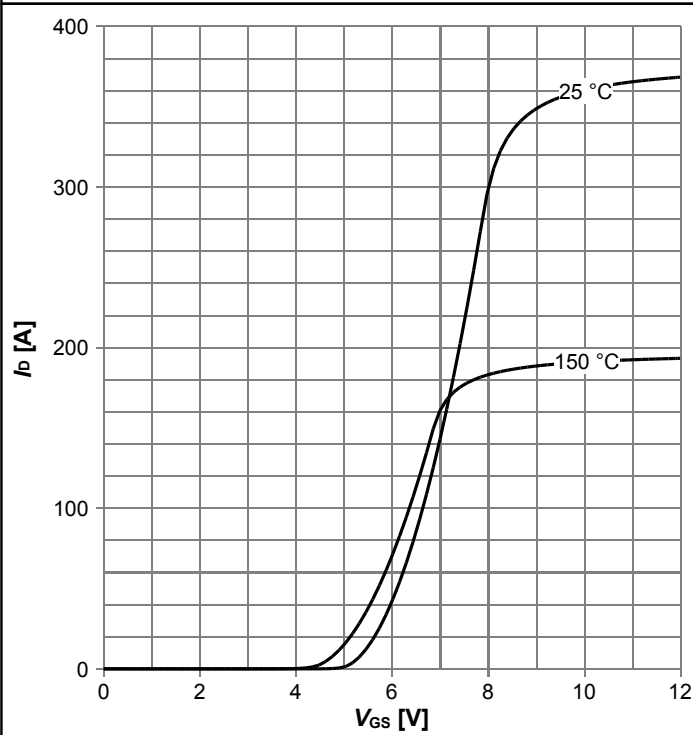
**Diagram 8: Drain-source on-state resistance**



$R_{DS(on)}=f(T_j); I_D=24.8\text{ A}; V_{GS}=10\text{ V}$

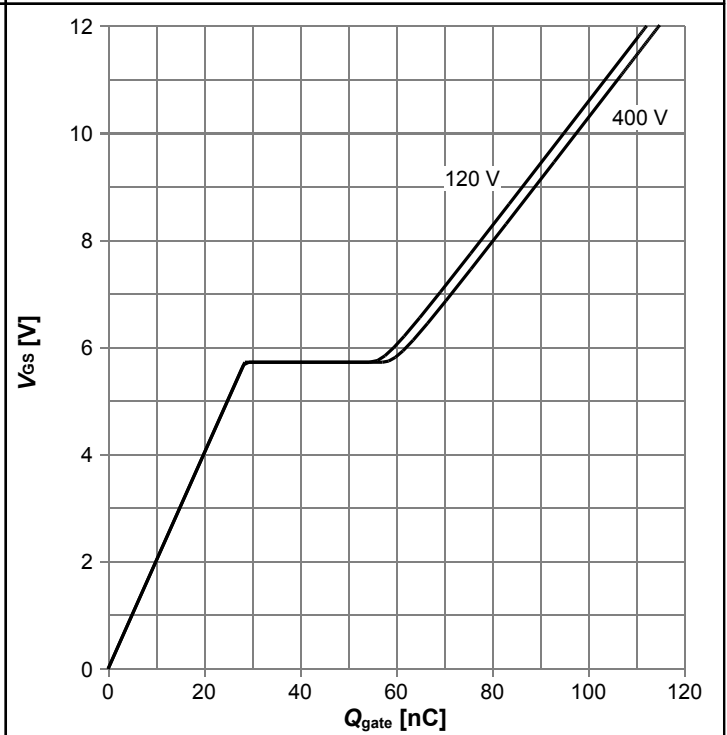


Diagram 9: Typ. transfer characteristics



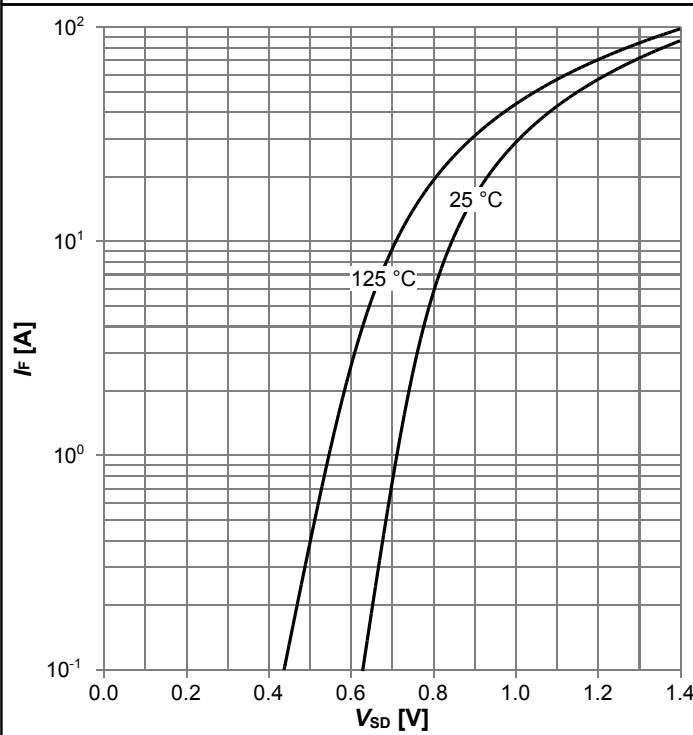
$I_D=f(V_{GS}); V_{DS}=20V; \text{parameter: } T_j$

Diagram 10: Typ. gate charge



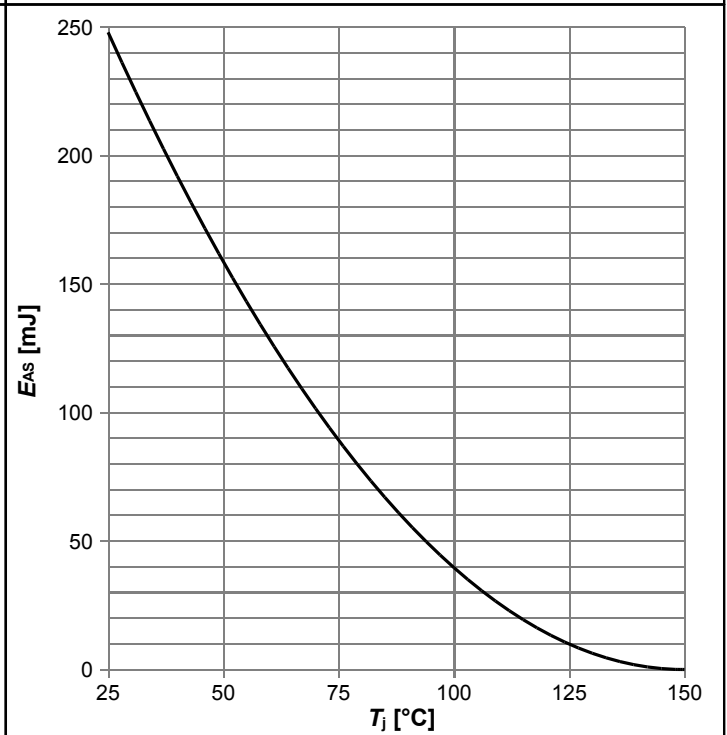
$V_{GS}=f(Q_{gate}); I_D=24.8 \text{ A pulsed}; \text{parameter: } V_{DD}$

Diagram 11: Forward characteristics of reverse diode



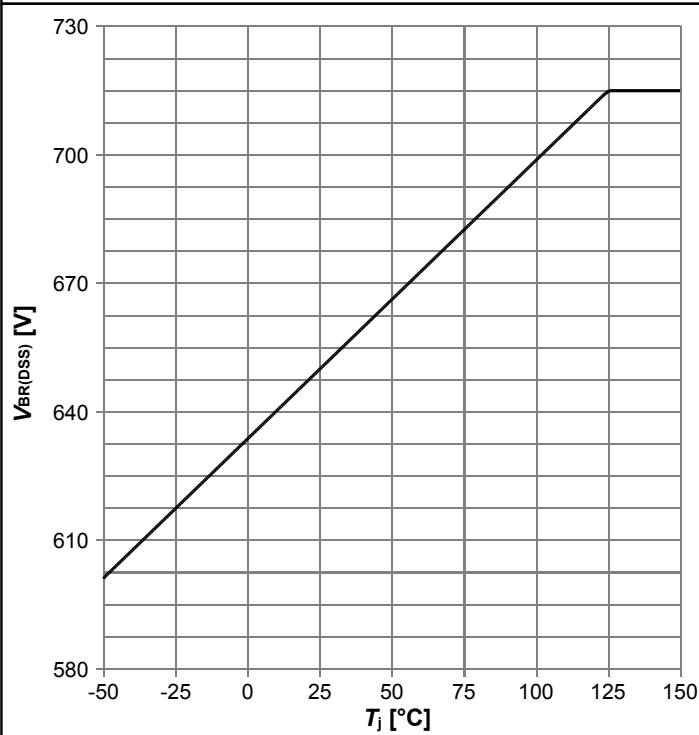
$I_F=f(V_{SD}); \text{parameter: } T_j$

Diagram 12: Avalanche energy



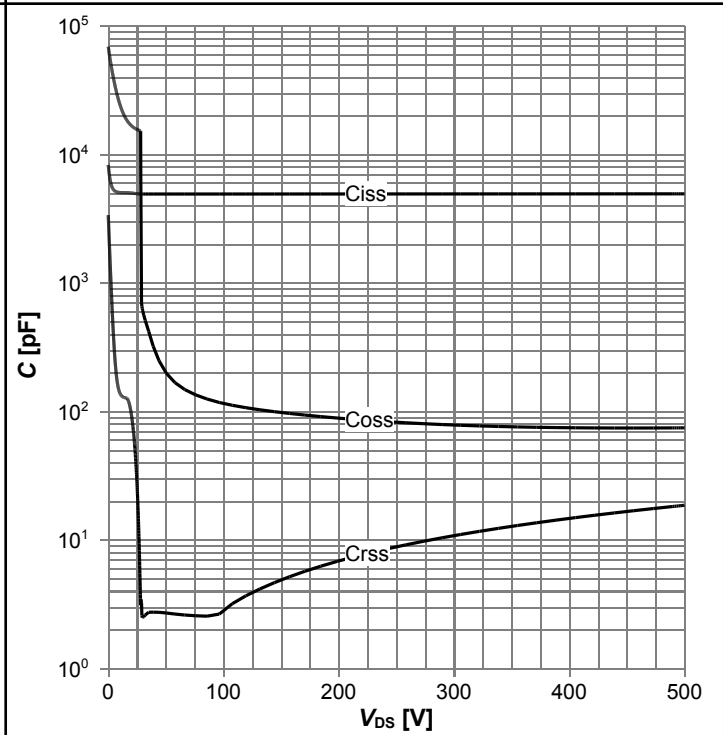
$E_{AS}=f(T_j); I_D=6.4 \text{ A}; V_{DD}=50 \text{ V}$

**Diagram 13: Drain-source breakdown voltage**



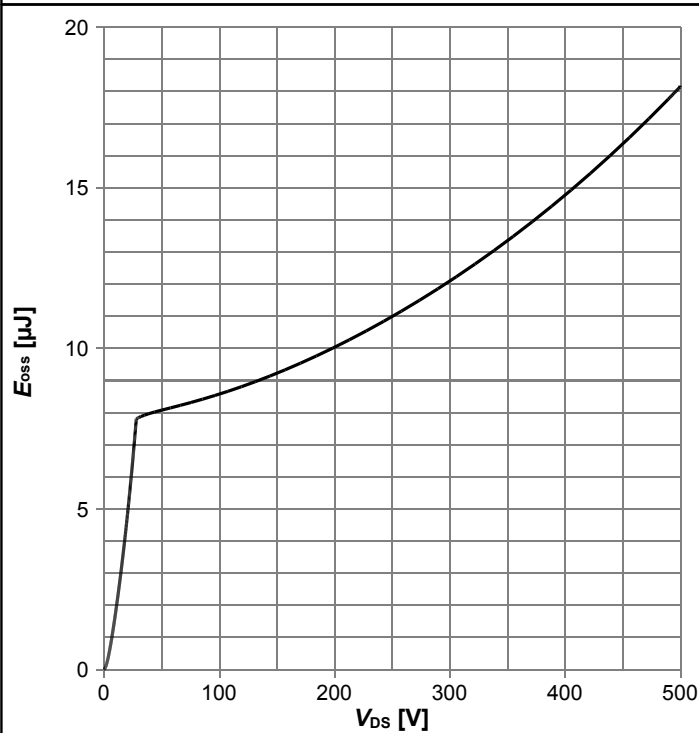
$V_{BR(DSS)}=f(T_j); I_D=1\text{ mA}$

**Diagram 14: Typ. capacitances**



$C=f(V_{DS}); V_{GS}=0\text{ V}; f=250\text{ kHz}$

**Diagram 15: Typ. Coss stored energy**



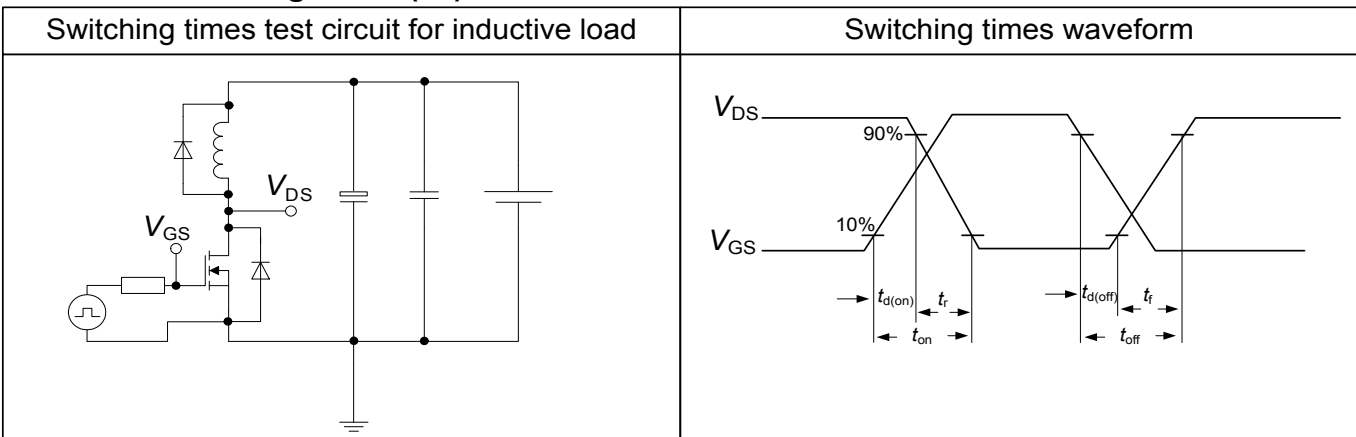
$E_{oss}=f(V_{DS})$

## 5 Test Circuits

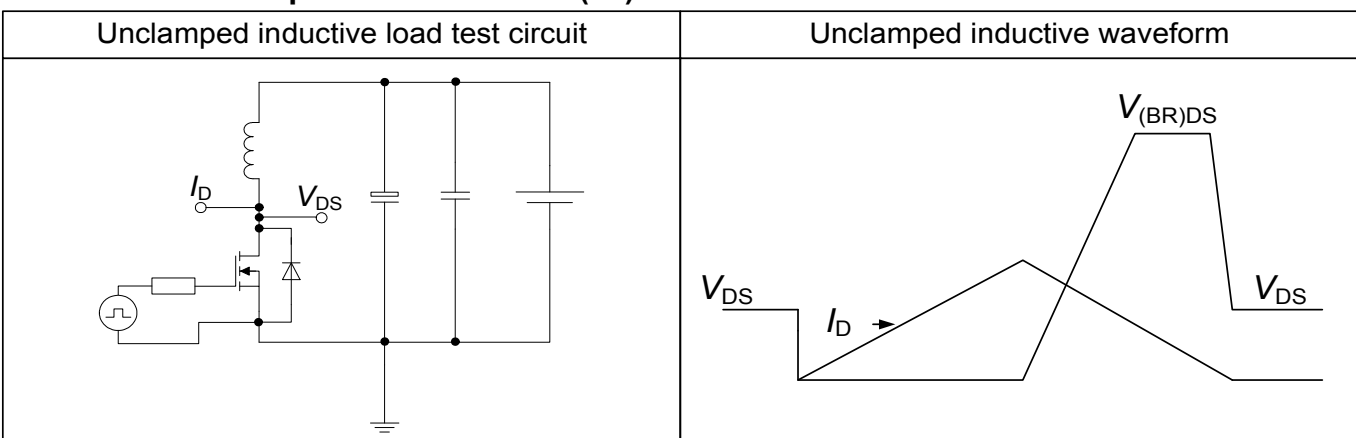
**Table 8 Diode characteristics**



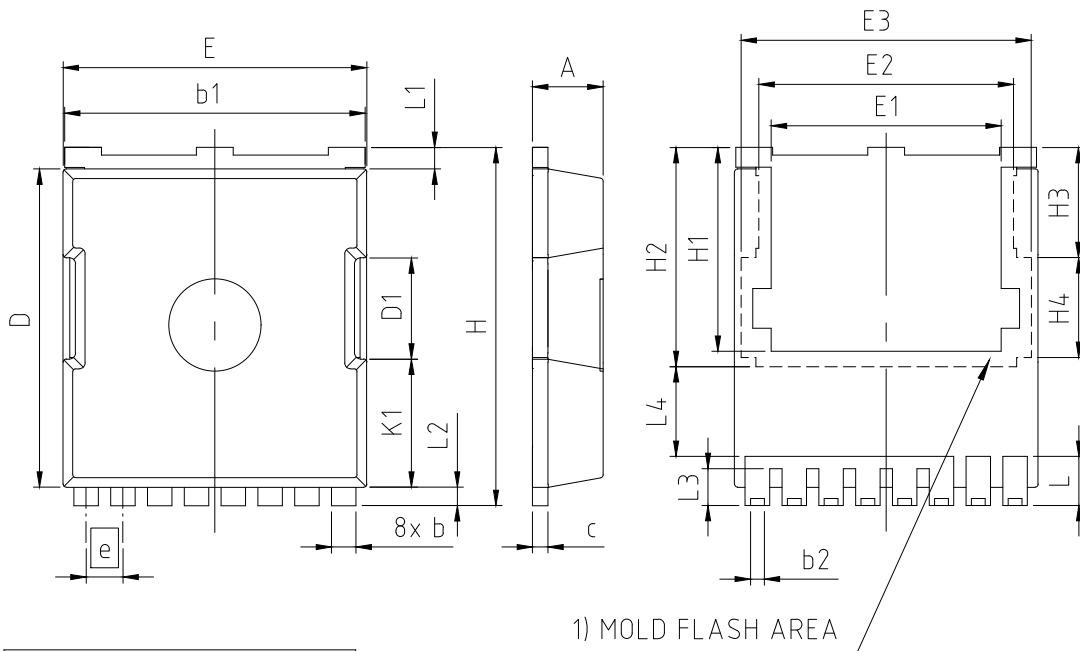
**Table 9 Switching times (ss)**



**Table 10 Unclamped inductive load (ss)**



## 6 Package Outlines



1) MOLD FLASH AREA

PACKAGE - GROUP NUMBER:		PG-HSOF-8-U02	
DIMENSIONS	MILLIMETERS		
	MIN.	MAX.	
A	2.20	2.40	
b	0.70	0.90	
b1	9.70	9.90	
b2	0.42	0.50	
c	0.40	0.60	
D	10.28	10.58	
D1	3.30		
E	9.70	10.10	
E1	7.50		
E2	8.50		
E3	9.46		
e	1.20 (BSC)		
H	11.48	11.88	
H1	6.55	6.95	
H2	7.15		
H3	3.59		
H4	3.26		
N	8		
K1	4.18		
L	1.40	1.80	
L1	0.50	0.90	
L2	0.50	0.70	
L3	1.00	1.30	
L4	2.62	2.81	

1) PARTIALLY COVERED WITH MOLD FLASH

Figure 1 Outline PG-HSOF-8, dimensions in mm

## 7 Appendix A

### Table 11 Related Links

- IFX CoolMOS CFD7 650V Webpage: [www.infineon.com](http://www.infineon.com)
- IFX CoolMOS CFD7 650V application note: [www.infineon.com](http://www.infineon.com)
- IFX CoolMOS CFD7 650V simulation model: [www.infineon.com](http://www.infineon.com)
- IFX Design tools: [www.infineon.com](http://www.infineon.com)

## Revision History

IPT65R040CFD7

**Revision: 2022-08-04, Rev. 2.1**

Previous Revision

Revision	Date	Subjects (major changes since last revision)
2.0	2022-08-02	Release of final version
2.1	2022-08-04	Updated Zero gate voltage drain current (IDSS) Max Value

### Trademarks

All referenced product or service names and trademarks are the property of their respective owners.

### We Listen to Your Comments

Any information within this document that you feel is wrong, unclear or missing at all? Your feedback will help us to continuously improve the quality of this document. Please send your proposal (including a reference to this document) to:

[erratum@infineon.com](mailto:erratum@infineon.com)

### Published by

**Infineon Technologies AG**

**81726 München, Germany**

**© 2022 Infineon Technologies AG**

**All Rights Reserved.**

### Legal Disclaimer

The information given in this document shall in no event be regarded as a guarantee of conditions or characteristics ("Beschaffheitsgarantie").

With respect to any examples, hints or any typical values stated herein and/or any information regarding the application of the product, Infineon Technologies hereby disclaims any and all warranties and liabilities of any kind, including without limitation warranties of non-infringement of intellectual property rights of any third party.

In addition, any information given in this document is subject to customer's compliance with its obligations stated in this document and any applicable legal requirements, norms and standards concerning customer's products and any use of the product of Infineon Technologies in customer's applications.

The data contained in this document is exclusively intended for technically trained staff. It is the responsibility of customer's technical departments to evaluate the suitability of the product for the intended application and the completeness of the product information given in this document with respect to such application.

### Information

For further information on technology, delivery terms and conditions and prices please contact your nearest Infineon Technologies Office ([www.infineon.com](http://www.infineon.com)).

### Warnings

Due to technical requirements, components may contain dangerous substances. For information on the types in question, please contact the nearest Infineon Technologies Office.

The Infineon Technologies component described in this Data Sheet may be used in life-support devices or systems and/or automotive, aviation and aerospace applications or systems only with the express written approval of Infineon Technologies, if a failure of such components can reasonably be expected to cause the failure of that life-support, automotive, aviation and aerospace device or system or to affect the safety or effectiveness of that device or system. Life support devices or systems are intended to be implanted in the human body or to support and/or maintain and sustain and/or protect human life. If they fail, it is reasonable to assume that the health of the user or other persons may be endangered.