

9-2348795-1 ✓ ACTIVE

AMP | Heavy Duty Sealed Connector Series, MATEnet

TE Internal #: 9-2348795-1

Data Connectivity Housings, Housing for Female Terminals, A, Wire-to-Board / Wire-to-Wire, 14 Position, Heavy Duty Sealed Connector Series

[View on TE.com >](#)



Connectors > Automotive Connectors > Data Connectivity Systems > Data Connectivity Housings

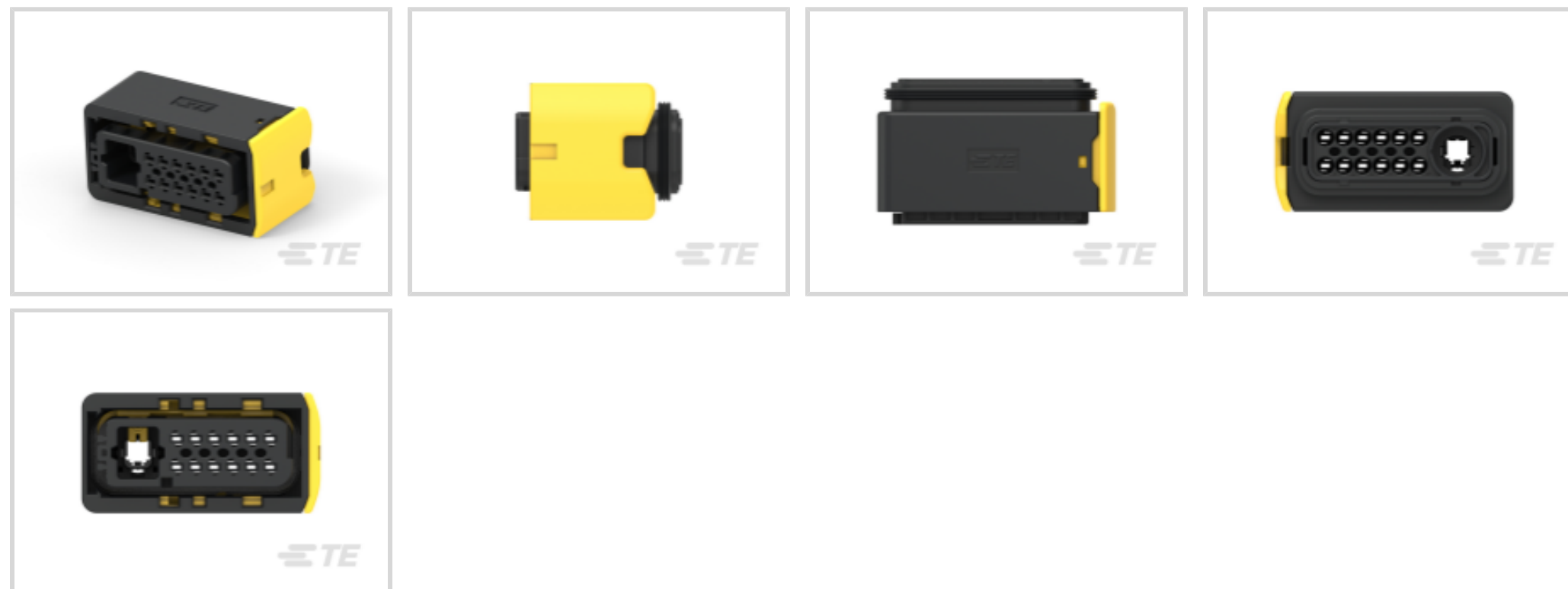

Connector & Housing Type: **Housing for Female Terminals**

Mating Tab Width: **.5 mm, 1.6 mm [ .019 in, .062 in ]**

Mating Tab Thickness: **.4 mm, .6 mm [ .015 in, .023 in ]**

Connector & Keying Code: **A**

Connector System: **Wire-to-Board, Wire-to-Wire**

## Features

### Product Type Features

Hybrid Connector	Yes
Connector & Housing Type	Housing for Female Terminals
Connector System	Wire-to-Board, Wire-to-Wire
Sealable	Yes
Connector & Contact Terminates To	Wire & Cable

### Configuration Features

Number of Positions	14
---------------------	----

### Electrical Characteristics

Operating Voltage	60 VDC
-------------------	--------

### Body Features

Cable Exit Type	Straight to Angled, Straight to Straight
Ferrule	With
Body Material	PBT GF
Connector & Keying Code	A



Cable Exit Angle	180°
------------------	------

### Contact Features

Center Contact	With
----------------	------

Contact Type	Receptacle
--------------	------------

Contact Mating Area Plating Material	Silver
--------------------------------------	--------

RF Connector Center Contact Plating Material	Silver (Ag)
--	-------------

Mating Tab Width	.5 mm, 1.6 mm [.019 in] [.062 in]
------------------	-----------------------------------

Mating Tab Thickness	.4 mm, .6 mm [.015 in] [.023 in]
----------------------	----------------------------------

Contact Current Rating (Max)	3 A, 20 A
------------------------------	-----------

### Termination Features

Termination Method to Wire & Cable	Crimp
------------------------------------	-------

### Mechanical Attachment

Mating Retention	With
------------------	------

Connector Mounting Type	Cable Mount (Free-Hanging)
-------------------------	----------------------------

### Housing Features

Housing Color	Black
---------------	-------

Centerline (Pitch)	4 mm [.157 in]
--------------------	----------------

### Dimensions

Connector Height	25.7 mm [1.01 in]
------------------	-------------------

Product Width	31.25 mm [1.23 in]
---------------	--------------------

Product Length	67.2 mm [2.64 in]
----------------	-------------------

### Usage Conditions

Operating Temperature (Max)	125 °C [257 °F]
-----------------------------	-----------------

Cable Type	STP, UTP
------------	----------

Operating Temperature Range	-40 – 125 °C [-40 – 257 °F]
-----------------------------	-----------------------------

### Operation/Application

Shielded	Yes
----------	-----

Circuit Application	Power & Signal
---------------------	----------------

### Industry Standards

Agency/Standard	ISO 8092
-----------------	----------

IP Rating	IP67, IP6K9K
-----------	--------------



## Packaging Features

Packaging Method	Box
------------------	-----

## Other

Outer Contact Plating Material	Nickel (Ni)
--------------------------------	-------------

Dielectric Material	PA GF
---------------------	-------

## Product Compliance

[For compliance documentation, visit the product page on TE.com>](#)

EU RoHS Directive 2011/65/EU	Compliant
------------------------------	-----------

EU ELV Directive 2000/53/EC	Compliant
-----------------------------	-----------

China RoHS 2 Directive MIIT Order No 32, 2016	No Restricted Materials Above Threshold
---	---

EU REACH Regulation (EC) No. 1907/2006	Current ECHA Candidate List: JAN 2023 (233) Candidate List Declared Against: JUNE 2022 (224) Does not contain REACH SVHC
--	--

Halogen Content	Not Low Halogen - contains Br or Cl > 900 ppm.
-----------------	--

Solder Process Capability	Not reviewed for solder process capability
---------------------------	--

### Product Compliance Disclaimer

This information is provided based on reasonable inquiry of our suppliers and represents our current actual knowledge based on the information they provided. This information is subject to change. The part numbers that TE has identified as EU RoHS compliant have a maximum concentration of 0.1% by weight in homogenous materials for lead, hexavalent chromium, mercury, PBB, PBDE, DBP, BBP, DEHP, DIBP, and 0.01% for cadmium, or qualify for an exemption to these limits as defined in the Annexes of Directive 2011/65/EU (RoHS2). Finished electrical and electronic equipment products will be CE marked as required by Directive 2011/65/EU. Components may not be CE marked. Additionally, the part numbers that TE has identified as EU ELV compliant have a maximum concentration of 0.1% by weight in homogenous materials for lead, hexavalent chromium, and mercury, and 0.01% for cadmium, or qualify for an exemption to these limits as defined in the Annexes of Directive 2000/53/EC (ELV). Regarding the REACH Regulation, the information TE provides on SVHC in articles for this part number is based on the latest European Chemicals Agency (ECHA) 'Guidance on requirements for substances in articles' posted at this URL: <https://echa.europa.eu/guidance-documents/guidance-on-reach>

## Compatible Parts



TE Part # CAT-H3399-B128  
Heavy Duty Sealed Connector Series Backshells



TE Part # 2112303-1  
PROTECTION CAP, FOR REC.HSG GROUP E



TE Part # CAT-AM705-T273  
AMP MCP, RECEPTACLE AND TAB



TE Part # 2287497-1  
SINGLE WIRE SEAL, 1.5MM CONTACT SYSTEM



TE Part # 2348770-1  
HD MATEnet - COVER FOR SWS



TE Part # 2348770-2  
HD MATEnet - COVER FOR SWS



TE Part # 2348770-3  
HD MATEnet - COVER FOR SWS



TE Part # 2348771-1  
HD MATEnet SWS



TE Part # 2348771-2  
HD MATEnet SWS



TE Part # 2356256-1  
HD MATEnet BLIND PLUG



TE Part # 9-2348792-1  
HD MATEnet 1+12 TAB HSG ASSY, GRP E



TE Part # 1670762-1  
SLIDE, 4-18 POS



TE Part # 1670764-1  
RADIAL SEAL 11 X 38



TE Part # 9-2375228-1  
HDSENET 1+12 HDR ASSY E, 90DEG, CODE A



TE Part # 9-2375230-1  
HDSENET 1+12 HDR HSG E, 180DEG, CODE A



TE Part # 9-2348798-1  
HD MATEnet 1+12 TAB ASSY, GRP E, FLANGED

Also in the Series | **Heavy Duty Sealed Connector Series**



Automotive Connector Caps & Covers (25)



Automotive Housings(207)



Automotive Seals & Cavity Plugs(5)

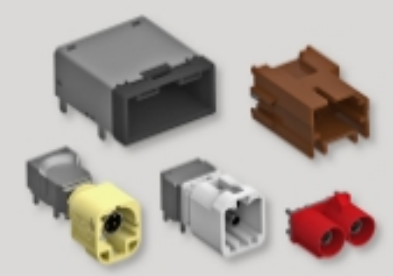

Data Connectivity Headers(2)





Data Connectivity Housings(18)

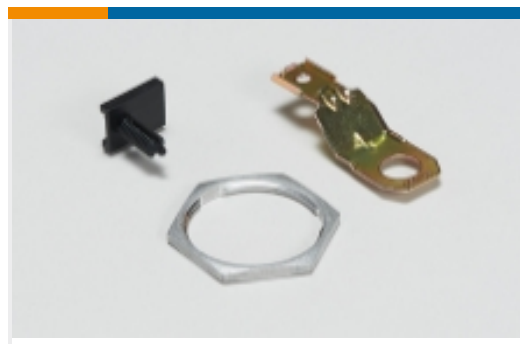

Other Automotive Connector Accessories(34)

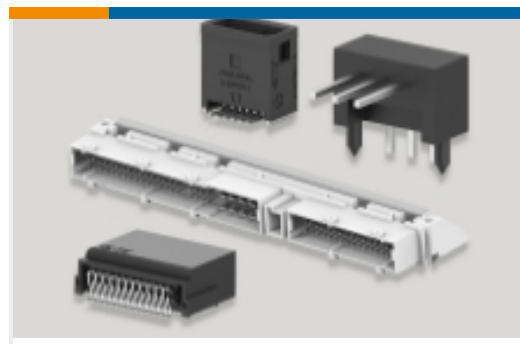

PCB Headers & Receptacles(1)

Also in the Series | **MATEnet**



Automotive Connector Caps & Covers (5)



Automotive Housings(1)



Automotive Seals & Cavity Plugs(5)



Data Connectivity Headers(7)



Data Connectivity Housings(31)



Other Automotive Connector Accessories(1)

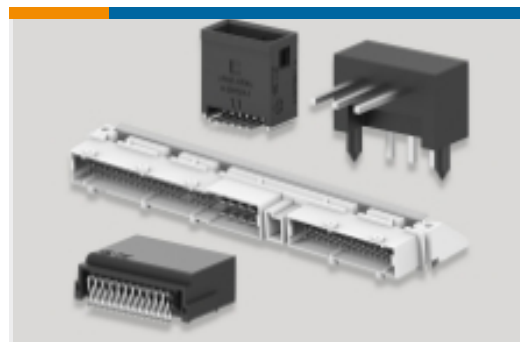

PCB Headers & Receptacles(2)

Customers Also Bought



TE Part #2040594-1  
SEAL CAP HSG 2P, AMPSEAL16 SEA



TE Part #2035366-2  
AMPSEAL 16 Connectors Backshell



TE Part #1028-027-0405  
BKSHL, 4P, BLK, REC, ST, NW 8.5



TE Part #3-1534903-2  
60POS MIXED MQS REC SEALED  
COD 2-3-6-7

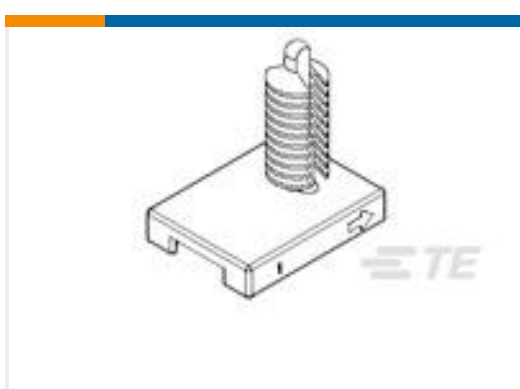

TE Part #1924487-1  
MOUNTING CLIP, AMPSEAL 16



TE Part #1-2203769-2  
Plug Ass'y, 2P Sealed, Key B, CPA



TE Part #2098641-4  
2POS, MCON 1.2 CB REC 2p SL  
SEALED



## Documents

### Product Drawings

[HD MATEnet 1+12 REC HSG ASSY, GRP E](#)

English

---

### CAD Files

[3D PDF](#)

3D

Customer View Model

[ENG\\_CVM\\_CVM\\_9-2348795-1\\_A.2d\\_dxf.zip](#)

English

Customer View Model

[ENG\\_CVM\\_CVM\\_9-2348795-1\\_A.3d\\_igs.zip](#)

English

Customer View Model

[ENG\\_CVM\\_CVM\\_9-2348795-1\\_A.3d\\_stp.zip](#)

English

By downloading the CAD file I accept and agree to the [Terms and Conditions](#) of use.

---

### Product Specifications

[Application Specification](#)

English