

Reflective Optical Sensor With VCSEL and Transistor Output



LINKS TO ADDITIONAL RESOURCES



FEATURES

- Package type: SMD
- Detector type: phototransistor
- Dimensions (L x W x H in mm): 1.85 x 1.2 x 0.6
- Emitter wavelength: 940 nm
- Moisture sensitivity level (MSL): 3
- Material categorization:
for definitions of compliance please see
www.vishay.com/doc?99912



APPLICATIONS

- Position sensor
- Optical switch
- Optical encoder
- Object detection (e.g. paper presence in printer and copy machines)

DESCRIPTION

The VCNT2030 is a reflective sensor in a miniature SMD package. It has a compact construction where the emitting light source and the detector are arranged in the same plane. The emitter uses a vertical cavity surface emitting laser (VCSEL) chip technology with high radiant intensity, high optical power, and high speed. The operating infrared wavelength is 940 nm. The detector consists of a silicon phototransistor. The sensor's analog output signal at the phototransistor is dependant on the amount of the light emitted by the VCSEL and reflected of an object in the sensor's field of view.



PRODUCT SUMMARY				
PART NUMBER	DISTANCE FOR MAXIMUM CTR _{rel} (1) (mm)	DISTANCE RANGE FOR I _C > 0.5 mA (mm)	TYPICAL OUTPUT CURRENT UNDER TEST (2) (mA)	DAYLIGHT BLOCKING FILTER INTEGRATED
VCNT2030	0.9	0.3 to 6	2.5	No

Notes

- (1) CTR: current transfer ratio, I_{out}/I_{in}
- (2) Conditions like in table basic characteristics / sensors

ORDERING INFORMATION			
ORDERING CODE	PACKAGING	VOLUME (1)	REMARKS
VCNT2030	Tape and reel	MOQ: 3000	Drypack, MSL 3

Note

- (1) MOQ: minimum order quantity

ABSOLUTE MAXIMUM RATINGS (T _{amb} = 25 °C, unless otherwise specified)				
PARAMETER	TEST CONDITION	SYMBOL	VALUE	UNIT
INPUT (VCSEL)				
Reverse voltage		V _R	5	V
Forward current		I _F	15	mA
Power dissipation		P _{VCSEL}	38	mW
Junction temperature		T _J	100	°C
Thermal resistance junction to ambient	JESD 51	R _{thJA}	410	K/W
OUTPUT (DETECTOR)				
Collector emitter breakdown voltage	I _C = 0.1 mA, E = 0	V _{(BR)CEO}	20	V
Emitter collector voltage		V _{ECO}	7	V
Collector current		I _C	50	mA
Power dissipation		P _{PTR}	100	mW
Thermal resistance junction to ambient	JESD 51	R _{thJA}	380	K/W
SENSOR				
Total power dissipation		P _{tot}	138	mW
Ambient temperature range		T _{amb}	-40 to +85	°C
Storage temperature range		T _{stg}	-40 to +85	°C
Soldering temperature	In accordance with Fig. 14	T _{sd}	260	°C

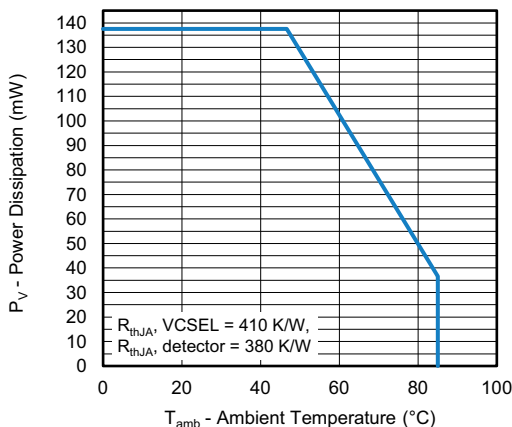

Fig. 1 - Power Dissipation vs. Ambient Temperature

BASIC CHARACTERISTICS ($T_{amb} = 25\text{ }^{\circ}\text{C}$, unless otherwise specified)						
PARAMETER	TEST CONDITION	SYMBOL	MIN.	TYP.	MAX.	UNIT
INPUT (VCSEL)						
Forward current ⁽¹⁾		I_F	-	5	-	mA
Forward voltage	$I_F = 8\text{ mA}$	V_F	1.7	1.9	2.1	V
	$I_F = 15\text{ mA}$		-	2.3	-	
Temperature coefficient of V_F	$I_F = 8\text{ mA}$	TKV_F	-	-4	-	mV/K
Angle of half intensity	$I_F = 8\text{ mA}$	ϕ	-	17	-	$^{\circ}$
Reverse current		I_R	Not designed for reverse operation			
Peak wavelength	$I_F = 8\text{ mA}$	λ_P	-	940	-	nm
OUTPUT (DETECTOR)						
Emitter collector voltage	$I_E = 100\text{ }\mu\text{A}$, $E = 0$	V_{ECO}	7	-	-	V
Collector emitter dark current	$V_{CE} = 5\text{ V}$, $E = 0$	I_{CEO}	-	1	100	nA
SENSOR						
Collector current	$V_{CE} = 5\text{ V}$, $I_F = 8\text{ mA}$, $d = 1\text{ mm}$	I_C	1.8	2.5	5.4	mA
Current transfer ratio	I_C/I_F , $d = 1\text{ mm}$, $V_{CE} = 5\text{ V}$	CTR	-	31	-	%
Rise time	$I_C = 0.8\text{ mA}$, $V_{CE} = 5\text{ V}$, $R_L = 100\text{ }\Omega$	t_r	-	10	-	μs
Fall time	$I_C = 0.8\text{ mA}$, $V_{CE} = 5\text{ V}$, $R_L = 100\text{ }\Omega$	t_f	-	15	-	μs

Note

(1) It is recommended to apply at least 5 mA forward current, to ensure expected device performance

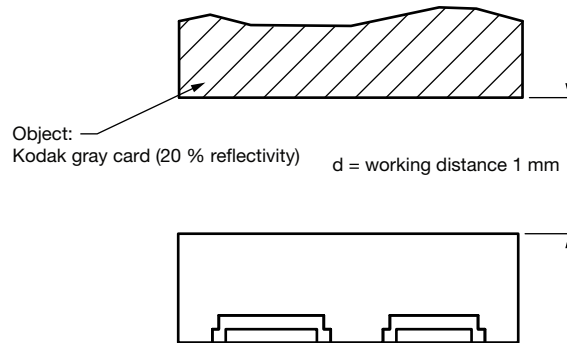

Fig. 2 - Test Circuit

BASIC CHARACTERISTICS ($T_{amb} = 25\text{ }^{\circ}\text{C}$, unless otherwise specified)

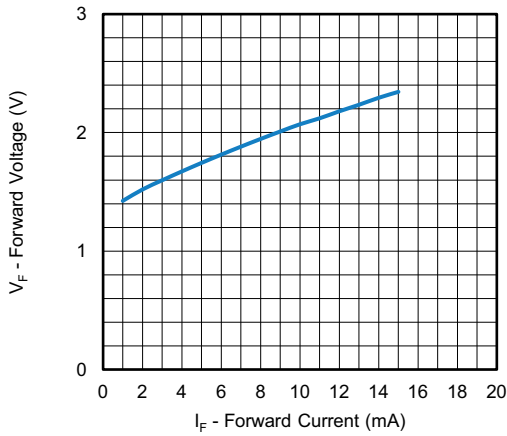

Fig. 3 - Forward Voltage vs. Forward Current

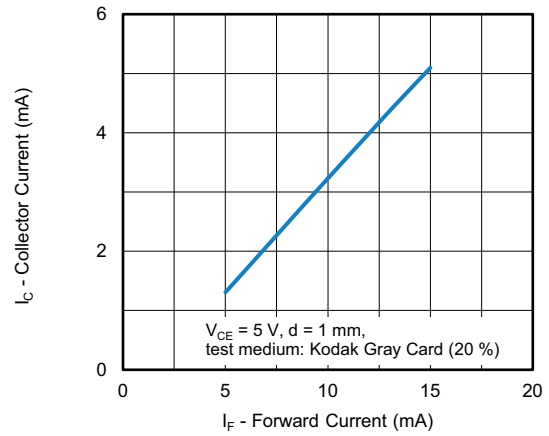

Fig. 6 - Collector Current vs. Forward Current

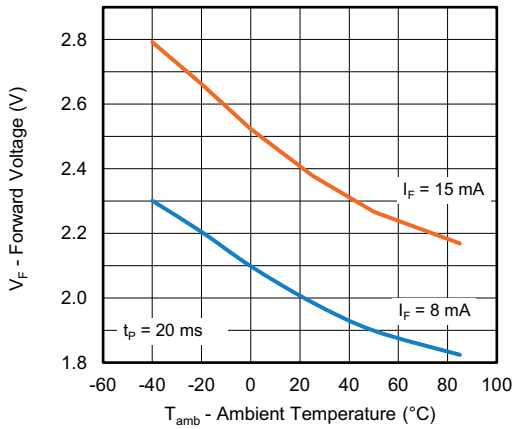

Fig. 4 - Forward Voltage vs. Ambient Temperature

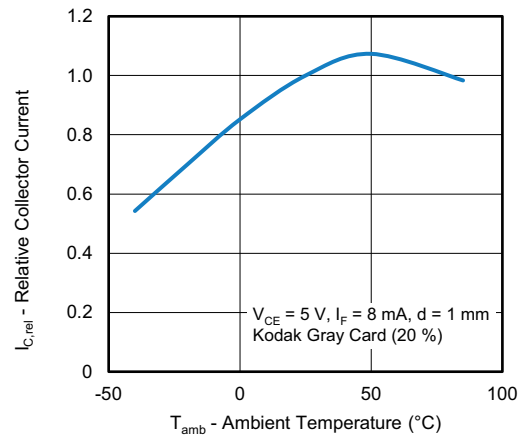

Fig. 7 - Relative Collector Current vs. Ambient Temperature

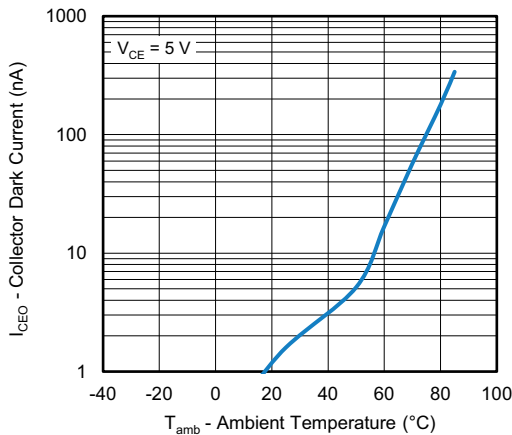

Fig. 5 - Collector Dark Current vs. Ambient Temperature

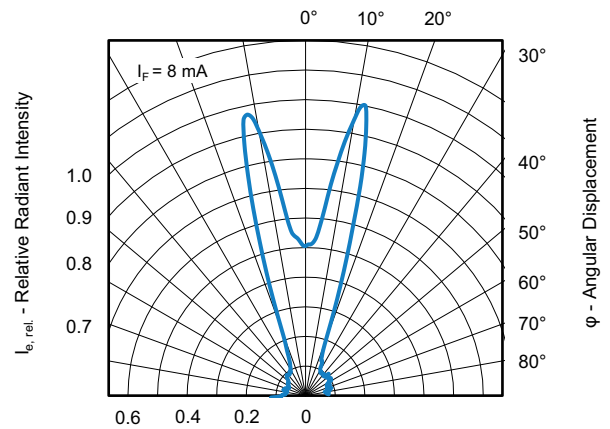

Fig. 8 - Relative Radiant Intensity vs. Angular Displacement

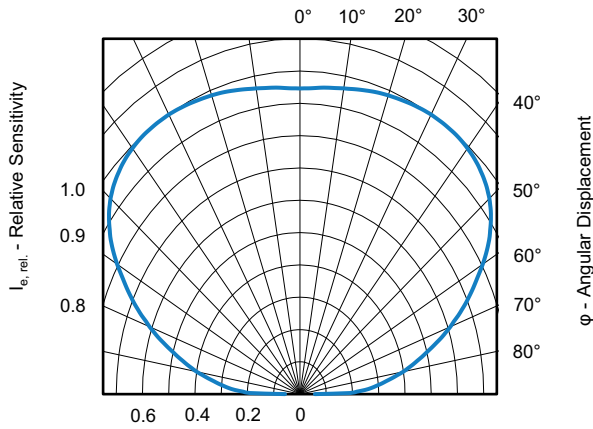

Fig. 9 - Relative Sensitivity vs. Angular Displacement

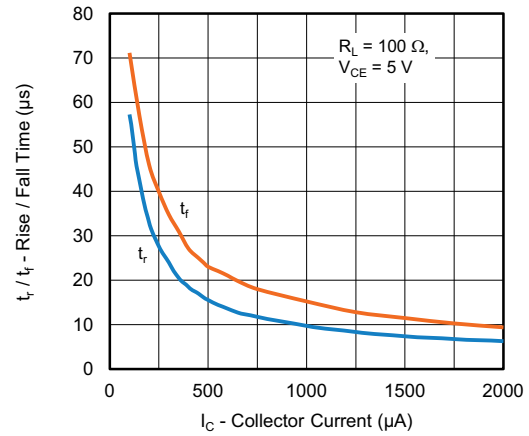

Fig. 12 - Rise / Fall Time vs. Collector Current

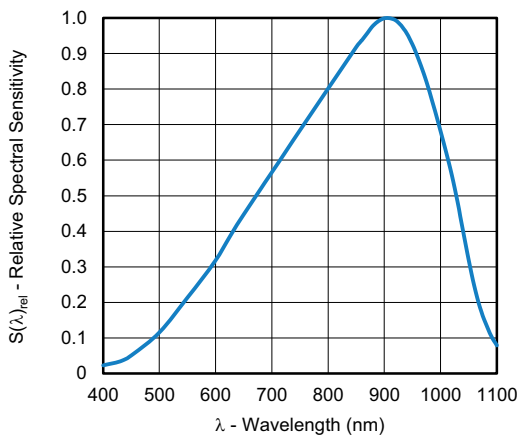

Fig. 10 - Relative Spectral Sensitivity vs. Wavelength

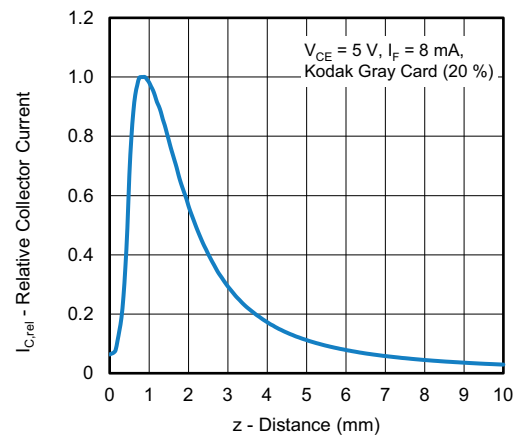

Fig. 13 - Relative Collector Current vs. Distance

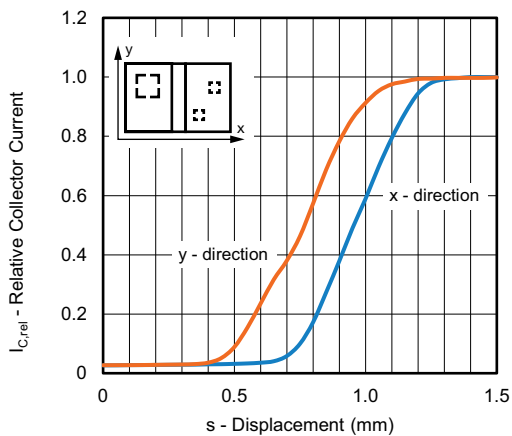

Fig. 11 - Relative Collector Current vs. Displacement

FLOOR LIFE

Time between soldering and removing from MBB must not exceed the time indicated in J-STD-020:

Moisture sensitivity: level 3

Floor life: 168 h

Conditions: $T_{amb} < 30\text{ }^{\circ}\text{C}$, RH < 60 %

DRYING

In case of moisture absorption devices should be baked before soldering. Conditions see J-STD-020 or recommended conditions:

192 h at 40 °C (+ 5 °C), RH < 5 %

or

96 h at 60 °C (+ 5 °C), RH < 5 %

PRECAUTIONS - EYE SAFETY

When VCSEL is in operation, looking into laser beam directly by naked eyes, even through a lens, microscope or optical fibers, may cause severe damage to human eyes. For observing laser beams, using safety goggles is recommended.

LABEL FOR LASER CLASS 1



Note

- Product specification with IEC / EN 60825-1:2014 compliance and above label

REFLOW SOLDER PROFILE

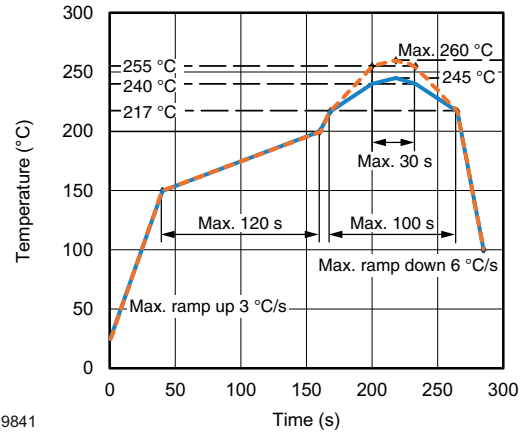

19841

Fig. 14 - Lead (Pb)-free Reflow Solder Profile According to J-STD-020

PACKAGE DIMENSIONS in millimeters

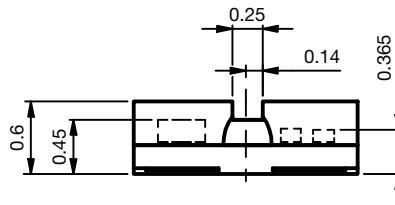
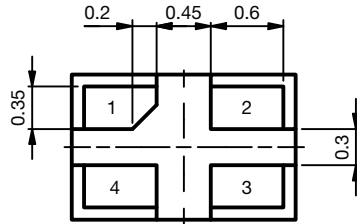

PIN	SIGNAL
1	Emitter
2	VCSEL_A
3	VCSEL_C
4	Collector

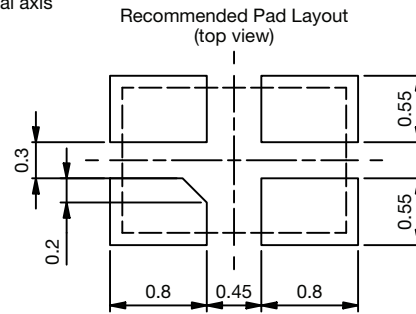
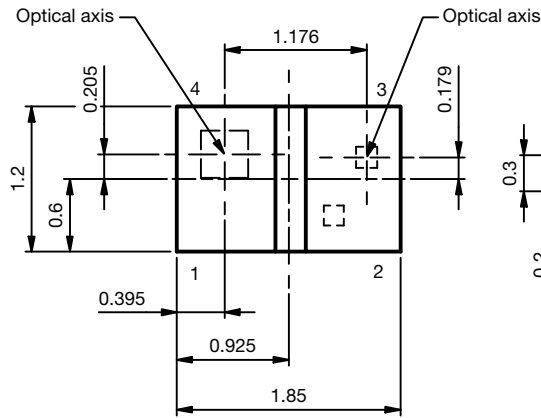

Not indicated tolerances ± 0.1

Drawing-No.: 6.550-5386.01-4
Issue: 1; 18.07.2022

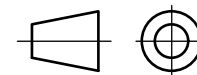

Technical drawings according to DIN specification

TAPE AND REEL DIMENSIONS in millimeters

3000 pcs/reel

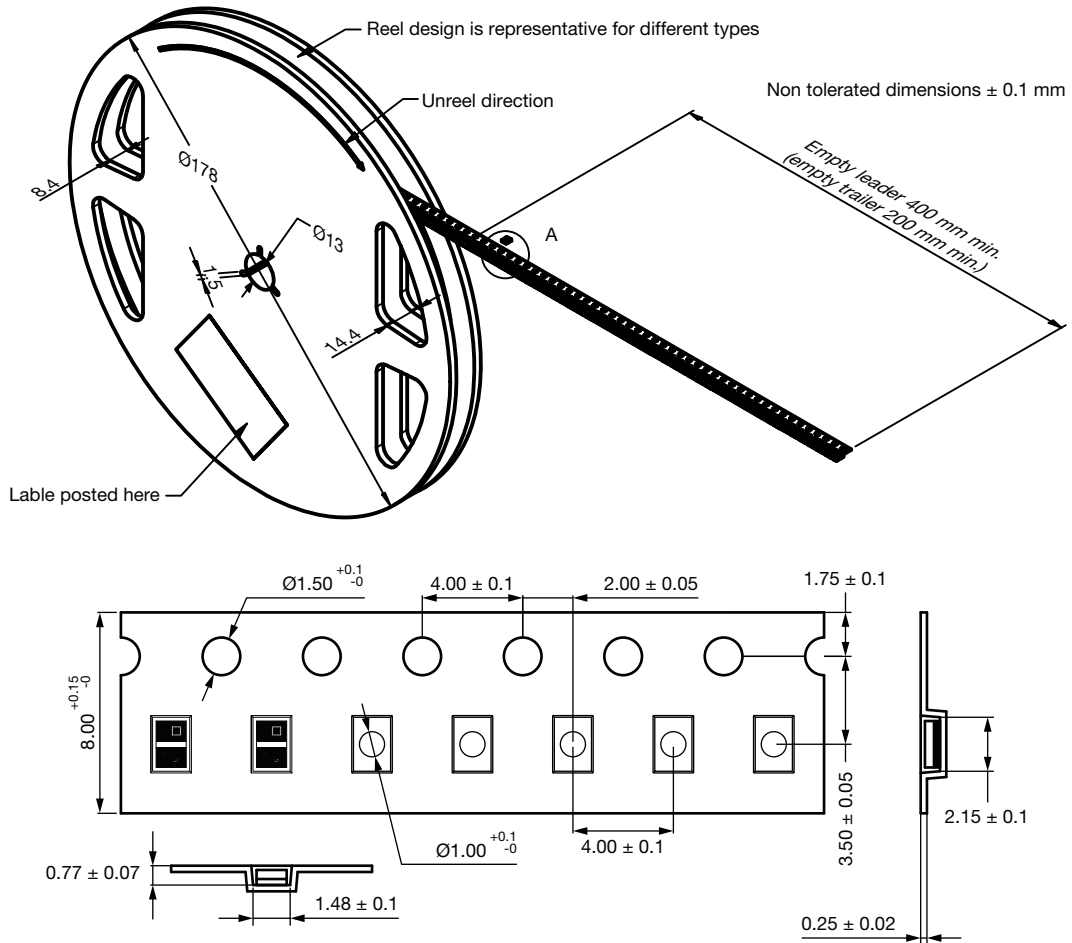

Drawing No.: 9.800-5149.01-4
Issue: 1; 05.12.2019



Disclaimer

ALL PRODUCT, PRODUCT SPECIFICATIONS AND DATA ARE SUBJECT TO CHANGE WITHOUT NOTICE TO IMPROVE RELIABILITY, FUNCTION OR DESIGN OR OTHERWISE.

Vishay Intertechnology, Inc., its affiliates, agents, and employees, and all persons acting on its or their behalf (collectively, "Vishay"), disclaim any and all liability for any errors, inaccuracies or incompleteness contained in any datasheet or in any other disclosure relating to any product.

Vishay makes no warranty, representation or guarantee regarding the suitability of the products for any particular purpose or the continuing production of any product. To the maximum extent permitted by applicable law, Vishay disclaims (i) any and all liability arising out of the application or use of any product, (ii) any and all liability, including without limitation special, consequential or incidental damages, and (iii) any and all implied warranties, including warranties of fitness for particular purpose, non-infringement and merchantability.

Statements regarding the suitability of products for certain types of applications are based on Vishay's knowledge of typical requirements that are often placed on Vishay products in generic applications. Such statements are not binding statements about the suitability of products for a particular application. It is the customer's responsibility to validate that a particular product with the properties described in the product specification is suitable for use in a particular application. Parameters provided in datasheets and / or specifications may vary in different applications and performance may vary over time. All operating parameters, including typical parameters, must be validated for each customer application by the customer's technical experts. Product specifications do not expand or otherwise modify Vishay's terms and conditions of purchase, including but not limited to the warranty expressed therein.

Hyperlinks included in this datasheet may direct users to third-party websites. These links are provided as a convenience and for informational purposes only. Inclusion of these hyperlinks does not constitute an endorsement or an approval by Vishay of any of the products, services or opinions of the corporation, organization or individual associated with the third-party website. Vishay disclaims any and all liability and bears no responsibility for the accuracy, legality or content of the third-party website or for that of subsequent links.

Except as expressly indicated in writing, Vishay products are not designed for use in medical, life-saving, or life-sustaining applications or for any other application in which the failure of the Vishay product could result in personal injury or death. Customers using or selling Vishay products not expressly indicated for use in such applications do so at their own risk. Please contact authorized Vishay personnel to obtain written terms and conditions regarding products designed for such applications.

No license, express or implied, by estoppel or otherwise, to any intellectual property rights is granted by this document or by any conduct of Vishay. Product names and markings noted herein may be trademarks of their respective owners.