

Data Sheet | Item Number: 769-102

1-conductor female connector; CAGE CLAMP®; 4 mm²; Pin spacing 5 mm; 2-pole; coding finger; 4,00 mm²; gray

<https://www.wago.com/769-102>

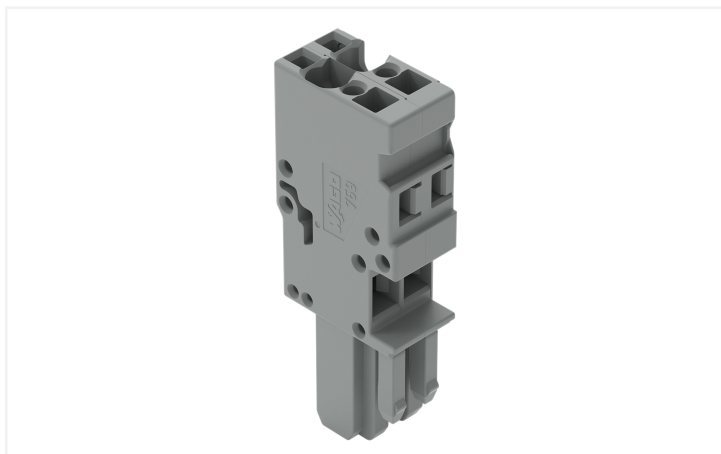

Color: ■ gray

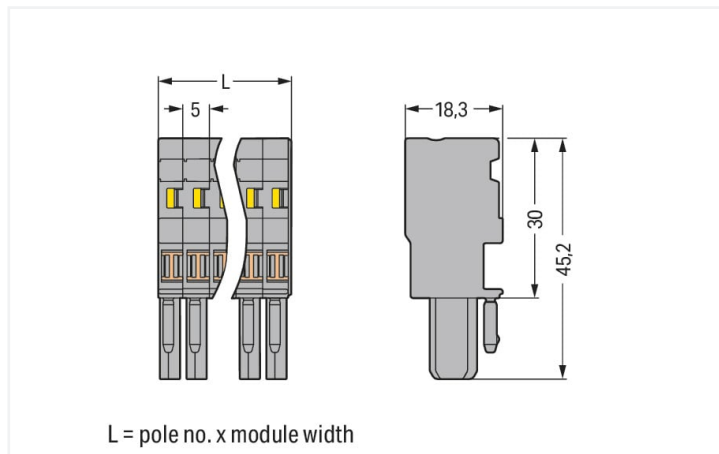

Dimensions in mm

Notes

Safety information

According to EN 61984, pluggable connectors without current interrupting capacity must not be mated or unmated when live or under load.

Electrical data

Ratings per	IEC/EN 61984		
	III	III	II
Overvoltage category	III	III	II
Pollution degree	3	2	2
Nominal voltage	500 V	-	-
Rated surge voltage	6 kV	-	-
Rated current	32 A	-	-

Connection data

Connection points	2
Total number of potentials	2

Connection 1

Connection technology	CAGE CLAMP®
Actuation type	Operating tool
Connectable conductor materials	Copper
Nominal cross-section	4 mm ² / 12 AWG
Solid conductor	0.08 ... 4 mm ² / 28 ... 12 AWG
Fine-stranded conductor	0.08 ... 4 mm ² / 28 ... 12 AWG
Strip length	8 ... 9 mm / 0.31 ... 0.35 inches
Pole number	2
Wiring direction	Front-entry wiring

Physical data

Width	10 mm / 0.394 inches
Height	45.2 mm / 1.78 inches
Depth	18.3 mm / 0.72 inches
Module width	5 mm / 0.197 inches

Mechanical data

Variable coding	Yes
Direct ground contact to DIN-rail/drilled hole/housing	No
Marking level	Side marking
Anti-rotation protection	Yes

Plug-in connection

Contact type (pluggable connector)	Female connector/socket
Connector (connection type)	for conductor
Mismating protection	No
Plugging without loss of pin spacing	Yes

Material data

Note (material data)	Information on material specifications can be found here
Color	gray
Material group	I
Insulation material	Polyamide (PA66)
Flammability class per UL94	V0
Fire load	0.141 MJ
Halogen-free	Yes
Weight	6.2 g

Environmental requirements

Processing temperature	-35 ... +85 °C
Continuous operating temperature	-60 ... +105 °C

Commercial data

Product Group	18 (X-COM-System)
eCl@ss 10.0	27-14-11-06
eCl@ss 9.0	27-14-11-06
ETIM 8.0	EC001284
ETIM 7.0	EC001284
PU (SPU)	100 pcs
Packaging type	Box
Country of origin	DE
GTIN	4044918471329
Customs tariff number	85366990990

Environmental Product Compliance

RoHS Compliance Status	Compliant, No Exemption
------------------------	-------------------------

Approvals / Certificates

General approvals



Approval	Standard	Certificate Name
CCA DEKRA Certification B.V.	EN 60947	NTR NL-7626
CCA DEKRA Certification B.V.	EN 61984	2190419.02
CCA DEKRA Certification B.V.	IEC 61984	NL-47799/A1
CSA DEKRA Certification B.V.	C22.2 No. 158	1101144
KEMA/KEUR DEKRA Certification B.V.	EN 60947	2190419.01
UL Underwriters Laboratories Inc.	UL 1977	E 45171
UR Underwriters Laboratories Inc.	UL 1059	E45172

Declarations of conformity and manufacturer's declarations

Approval	Standard	Certificate Name
EU-Declaration of Conformity WAGO GmbH & Co. KG	-	-
UK-Declaration of Conformity WAGO GmbH & Co. KG	-	-

Approvals for marine applications



Approval	Standard	Certificate Name
ABS American Bureau of Shipping	EN 60947	20-HG1941090-PDA
BV Bureau Veritas S.A.	EN 60947	07436/F0 BV

Downloads

Environmental Product Compliance

Compliance Search	
Environmental Product Compliance 769-102	↓

Documentation

Additional Information		
Technical Section	pdf 2142.18 KB	↓

Bid Text			
769-102	19.02.2019	xml 3.20 KB	↓
769-102	04.10.2017	doc 25.00 KB	↓

CAD/CAE-Data	
CAD data	CAE data
2D/3D Models 769-102 ↓	EPLAN Data Portal 769-102 ↓
	WSCAD Universe 769-102 ↓
	ZUKEN Portal 769-102 ↓

1 Compatible Products

1.1 Optional Accessories

1.1.1 Cover











1.1.1.1 Cover



Item No.: 769-436
 Jumper cover; for 1-conductor female plugs; for 5 poles; gray

1.1.2 Ferrule

1.1.2.1 Ferrule

 Item No.: 216-301 Ferrule; Sleeve for 0.25 mm ² / AWG 24; insulated; electro-tin plated; yellow	 Item No.: 216-302 Ferrule; Sleeve for 0.34 mm ² / 22 AWG; insulated; electro-tin plated; light turquoise	 Item No.: 216-201 Ferrule; Sleeve for 0.5 mm ² / 20 AWG; insulated; electro-tin plated; white	 Item No.: 216-101 Ferrule; Sleeve for 0.5 mm ² / AWG 22; un-insulated; electro-tin plated; silver-colored
 Item No.: 216-202 Ferrule; Sleeve for 0.75 mm ² / 18 AWG; insulated; electro-tin plated; gray	 Item No.: 216-102 Ferrule; Sleeve for 0.75 mm ² / AWG 20; un-insulated; electro-tin plated; silver-colored	 Item No.: 216-203 Ferrule; Sleeve for 1 mm ² / AWG 18; insulated; electro-tin plated; red	 Item No.: 216-103 Ferrule; Sleeve for 1 mm ² / AWG 18; un-insulated; electro-tin plated
 Item No.: 216-204 Ferrule; Sleeve for 1.5 mm ² / AWG 16; un-insulated; electro-tin plated; black	 Item No.: 216-104 Ferrule; Sleeve for 1.5 mm ² / AWG 16; un-insulated; electro-tin plated; silver-colored	 Item No.: 216-206 Ferrule; Sleeve for 2.5 mm ² / AWG 14; insulated; electro-tin plated; blue	

1.1.3 Insulation stop

1.1.3.1 Insulation stop



Item No.: 769-470

Insulation stop; 0.08 - 0.2 mm² "s" (0.14 mm² "f-st"); 5 pieces/strip; white



Item No.: 769-471

Insulation stop; 0.25 - 0.5 mm²; 5 pieces/strip; light gray



Item No.: 769-472

Insulation stop; 0.75 - 1 mm²; 5 pieces/strip; dark gray

1.1.4 Jumper

1.1.4.1 Jumper



Item No.: 769-402

Jumper; insulated; gray

1.1.5 Locking system

1.1.5.1 Locking system



Item No.: 769-430

Locking lever; for female connectors; 1 part; Pin spacing 5 mm; 2-pole; gray



Item No.: 769-431

Locking lever; for female connectors; 1 part; Pin spacing 5 mm; 2-pole; orange

1.1.6 Marking

1.1.6.1 Label



Item No.: 210-805

Labels; for Smart Printer; permanent adhesive; 6 x 15 mm; white



Item No.: 210-805/000-002

Labels; for Smart Printer; permanent adhesive; 6 x 15 mm; yellow

1.1.6.2 Marker



Item No.: 2009-145

Mini-WSB Inline; for Smart Printer; 1700 pieces on roll; stretchable 5 - 5.2 mm; plain; snap-on type; white



Item No.: 248-501

Mini-WSB marking card; as card; not stretchable; plain; snap-on type; white

1.1.6.3 Marking strip



Item No.: 210-831

Marking strips; on reel; 2.3 mm wide; plain; Self-adhesive; white



Item No.: 210-832

Marking strips; on reel; 3 mm wide; plain; Self-adhesive; white



Item No.: 210-834

Marking strips; on reel; 5 mm wide; plain; Self-adhesive; white

1.1.7 Protective warning marker

1.1.7.1 Cover



Item No.: 280-415
 Protective warning marker; for 5 terminal blocks; with high-voltage symbol, black; yellow

1.1.8 Strain relief

1.1.8.1 Strain relief



Item No.: 769-1602
 Strain relief housing; for female and male connectors; 2 parts; Pin spacing 5 mm; 2-pole; gray



Item No.: 769-411
 Strain relief plate; for female and male connectors; 1 part; Pin spacing 5 mm; 2- to 3-pole; gray

1.1.9 Test and measurement

1.1.9.1 Testing accessories



Item No.: 210-136
 Test plug; 2 mm Ø; with 500 mm cable; red

1.1.10 Tool

1.1.10.1 Operating tool



Item No.: 210-490
 Operating tool



Item No.: 769-434
 Operating tool; made of insulating material; 1-way; loose; white

Installation Notes

Conductor termination

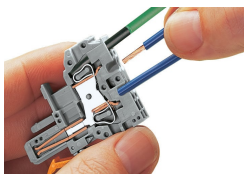

CAGE CLAMP® connection
 Female plug: Inserting/removing a conductor via operating tool.
 Operation 90° to conductor is also possible.
 With ferruled conductors, it is necessary to use a terminal block one size smaller than the conductor's nominal cross-section.

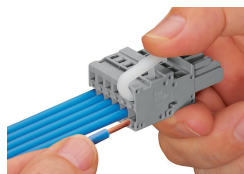

Operating lever
 Inserting a conductor – side-entry wiring (example shows a female plug).

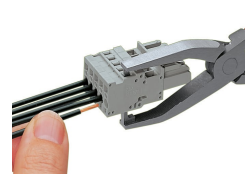

Operating tool
 Inserting a conductor – side-entry wiring (example shows a female plug).
 With ferruled conductors, it is necessary to use a terminal block one size smaller than the conductor's nominal cross-section.

Commoning

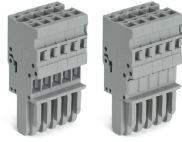
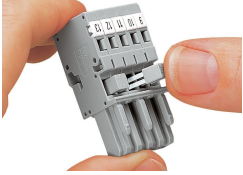

Commoning 1-conductor female plugs via miniature adjacent jumpers.

Jumper cover for 1-conductor female plugs

Coding



Coding a female plug by removing coding finger(s) via cutting tool. Do not remove the first and last coding fingers or use an additional locking lever.

Locking system

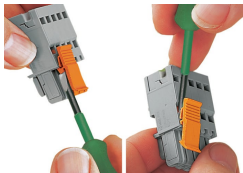

Locking/releasing a lever.

Strain relief



Removing a female plug via conductor bundle provided with strain relief plate.

Marking



Labeling a female plug with CAGE CLAMP® connection via Mini-WSB Quick Markers.