

Data sheet | Item number: 769-104/021-000

1-conductor female connector; CAGE CLAMP®; 4 mm²; Pin spacing 5 mm; 4-pole; coding finger; Lateral locking levers; 4,00 mm²; gray

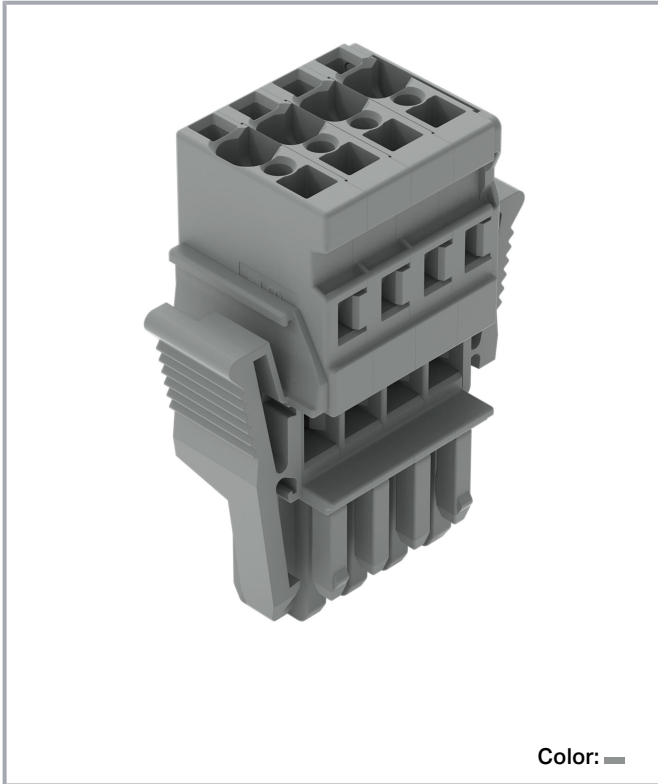

www.wago.com/769-104/021-000



Data

Notes

Safety information

According to EN 61984, pluggable connectors without current interrupting capacity must not be mated or unmated when live or under load.

Electrical data

Ratings per IEC/EN

Ratings per	IEC/EN 61984
Nominal voltage (III/3)	500 V
Rated impulse voltage (III/3)	6 kV
Rated current	32 A

Subject to changes. Please also observe the further product documentation!

WAGO GmbH & Co. KG
Hansastr. 27
32423 Minden
Phone: +49571 887-0 | Fax: +49571 887-169
Email: info.de@wago.com | Web: www.wago.com

Do you have any questions about our products?
We are always happy to take your call at +49 (571) 887-44222.



Legend (ratings)

(III / 3) $\hat{=}$ Overvoltage category III / Pollution degree 3

Connection data

Connection points	4
Total number of potentials	4

Connection 1

Connection technology	CAGE CLAMP®
Actuation type	Operating tool
Connectable conductor materials	Copper
Nominal cross-section	4 mm ² / 12 AWG
Solid conductor	0.08 ... 4 mm ² / 28 ... 12 AWG
Fine-stranded conductor	0.08 ... 4 mm ² / 28 ... 12 AWG
Strip length	8 ... 9 mm / 0.31 ... 0.35 inches
Pole number	4
Wiring direction	Front-entry wiring

Physical data

Width	35 mm / 1.402 inches
Height	45.2 mm / 1.78 inches
Depth	18.3 mm / 0.72 inches
Module width	5 mm / 0.197 inches

Mechanical Data

Variable coding	Yes
Direct ground contact to DIN-rail/drilled hole/housing	No
Marking level	Side marking
Anti-rotation protection	Yes

Plug-in connection

Contact type (pluggable connector)	Female connector/socket
Connector (connection type)	for conductor
Mismating protection	No
Plugging without loss of pin spacing	Yes
Locking lever	Yes

Subject to changes. Please also observe the further product documentation!



Material Data

Note (material data)

Information on material specifications can be found here

Color	gray
Material group	I
Insulation material	Polyamide (PA66)
Flammability class per UL94	V0
Fire load	0.331 MJ
Halogen-free	Yes
Weight	14.4 g

Environmental requirements

Processing temperature	-35 ... +85 °C
Continuous operating temperature	-60 ... +105 °C

Commercial data

eCl@ss 10.0	27-14-11-06
eCl@ss 9.0	27-14-11-06
ETIM 8.0	EC001284
ETIM 7.0	EC001284
PU (SPU)	25 pcs
Packaging type	box
Country of origin	DE
GTIN	4044918481274
Customs tariff number	85366990990

Environmental Product Compliance

RoHS Compliance Status	Compliant, No Exemption
------------------------	-------------------------

Approvals / Certificates



General approvals

Logo	Approval	Additional Approval Text	Certificate name
	CCA DEKRA Certification B.V.	EN 60947	NTR NL- 7626

Subject to changes. Please also observe the further product documentation!

	CCA DEKRA Certification B.V.	EN 61984	2190419.02
	CCA DEKRA Certification B.V.	IEC 61984	NL-47799 /A1
	CSA DEKRA Certification B.V.	C22.2 No. 158	1101144
	KEMA/KEUR DEKRA Certification B.V.	EN 60947	2190419.01
	UL Underwriters Laboratories Inc.	UL 1977	E 45171
	UR Underwriters Laboratories Inc.	UL 1059	E45172

Declarations of conformity and manufacturer's declarations

Logo	Approval	Additional Approval Text	Certificate name
	EU-Declaration of Conformity WAGO GmbH & Co. KG	-	-
	UK-Declaration of Conformity WAGO GmbH & Co. KG	-	-

Approvals for marine applications

Logo	Approval	Additional Approval Text	Certificate name
	ABS American Bureau of Shipping	EN 60947	20- HG1941090- PDA
	DNV GL	-	TAE00001V2

Subject to changes. Please also observe the further product documentation!

WAGO GmbH & Co. KG
Hansastr. 27
32423 Minden
Phone: +49571 887-0 | Fax: +49571 887-169
Email: info.de@wago.com | Web: www.wago.com

Do you have any questions about our products?
We are always happy to take your call at +49 (571) 887-44222.



Det Norske Veritas, Germanischer Lloyd

Optional accessories











Jumpers

Jumper

	Item no.: 769-402 Jumper; insulated; gray	www.wago.com/769-402
---	---	--

Ferrule

Ferrule

	Item no.: 216-101 Ferrule; Sleeve for 0.5 mm ² / AWG 22; uninsulated; electro-tin plated; silver-colored	www.wago.com/216-101
	Item no.: 216-104 Ferrule; Sleeve for 1.5 mm ² / AWG 16; uninsulated; electro-tin plated; silver-colored	www.wago.com/216-104
	Item no.: 216-102 Ferrule; Sleeve for 0.75 mm ² / AWG 20; uninsulated; electro-tin plated; silver-colored	www.wago.com/216-102
	Item no.: 216-103 Ferrule; Sleeve for 1 mm ² / AWG 18; uninsulated; electro-tin plated	www.wago.com/216-103
	Item no.: 216-203 Ferrule; Sleeve for 1 mm ² / AWG 18; insulated; electro-tin plated; red	www.wago.com/216-203
	Item no.: 216-206 Ferrule; Sleeve for 2.5 mm ² / AWG 14; insulated; electro-tin plated; blue	www.wago.com/216-206
	Item no.: 216-202 Ferrule; Sleeve for 0.75 mm ² / 18 AWG; insulated; electro-tin plated; gray	www.wago.com/216-202
	Item no.: 216-204 Ferrule; Sleeve for 1.5 mm ² / AWG 16; insulated; electro-tin plated; black	www.wago.com/216-204
	Item no.: 216-201 Ferrule; Sleeve for 0.5 mm ² / 20 AWG; insulated; electro-tin plated; white	www.wago.com/216-201
	Item no.: 216-301 Ferrule; Sleeve for 0.25 mm ² / AWG 24; insulated; electro-tin plated; yellow	www.wago.com/216-301
	Item no.: 216-302 Ferrule; Sleeve for 0.34 mm ² / 22 AWG; insulated; electro-tin plated; light turquoise	www.wago.com/216-302

Tool

Operating tool

	Item no.: 210-490	www.wago.com/210-490
---	--------------------------	--

Subject to changes. Please also observe the further product documentation!

Operating tool



Item no.: 769-434

Operating tool; made of insulating material; 1-way; loose; white

www.wago.com/769-434

Testing and measuring

Testing accessories



Item no.: 210-136

Test plug; 2 mm Ø; with 500 mm cable; red

www.wago.com/210-136

Insulation stop

Insulation stop



Item no.: 769-470

Insulation stop; 0.08 - 0.2 mm² "s" (0.14 mm² "f-st"); 5 pieces/strip; white

www.wago.com/769-470



Item no.: 769-471

Insulation stop; 0.25 - 0.5 mm²; 5 pieces/strip; light gray

www.wago.com/769-471



Item no.: 769-472

Insulation stop; 0.75 - 1 mm²; 5 pieces/strip; dark gray

www.wago.com/769-472

Marking accessories

Marking strip



Item no.: 210-831

Marking strips; on reel; 2.3 mm wide; plain; Self-adhesive; white

www.wago.com/210-831



Item no.: 210-834

Marking strips; on reel; 5 mm wide; plain; Self-adhesive; white

www.wago.com/210-834



Item no.: 210-832

Marking strips; on reel; 3 mm wide; plain; Self-adhesive; white

www.wago.com/210-832

Label



Item no.: 210-805

Labels; for Smart Printer; permanent adhesive; 6 x 15 mm; white

www.wago.com/210-805



Item no.: 210-805/000-002

Labels; for Smart Printer; permanent adhesive; 6 x 15 mm; yellow

www.wago.com/210-805/000-002

Marker



Item no.: 2009-145

Mini-WSB Inline; for Smart Printer; 1700 pieces on roll; stretchable 5 - 5.2 mm; plain; snap-on type; white

www.wago.com/2009-145

Subject to changes. Please also observe the further product documentation!

WAGO GmbH & Co. KG

Hansastr. 27

32423 Minden

Phone: +49571 887-0 | Fax: +49571 887-169

Email: info.de@wago.com | Web: www.wago.com

Do you have any questions about our products?

We are always happy to take your call at +49 (571) 887-44222.



Item no.: 248-501

Mini-WSB marking card; as card; not stretchable; plain; snap-on type; white

www.wago.com/248-501

Protective warning marker

Cover



Item no.: 280-415

Protective warning marker; for 5 terminal blocks; with high-voltage symbol, black; yellow

www.wago.com/280-415

Locking levers

Locking system



Item no.: 769-430

Locking lever; for female connectors; 1 part; Pin spacing 5 mm; 2-pole; gray

www.wago.com/769-430



Item no.: 769-431

Locking lever; for female connectors; 1 part; Pin spacing 5 mm; 2-pole; orange

www.wago.com/769-431

Strain relief

Strain relief



Item no.: 769-1604

Strain relief housing; for female and male connectors; 2 parts; Pin spacing 5 mm; 4-pole; gray

www.wago.com/769-1604



Item no.: 769-412

Strain relief plate; for female and male connectors; 1 part; Pin spacing 5 mm; 4- to 5-pole; gray

www.wago.com/769-412

Cover

Cover



Item no.: 769-436

Jumper cover; for 1-conductor female plugs; for 5 poles; gray

www.wago.com/769-436

Downloads

Documentation

Bid Text

769-104/021-000 X81 - Datei	19 Feb 2019	xml 3.3 kB	Download
769-104/021-000 doc - Datei	4 Oct 2017	doc 25.6 kB	Download

Additional Information

pdf
2.2 MB
Download

Subject to changes. Please also observe the further product documentation!



CAD/CAE-Data

CAD data

2D/3D Models 769-104/021-000	URL	Download
------------------------------	---------------------	--------------------------

CAE data

EPLAN Data Portal 769-104/021-000	URL	Download
-----------------------------------	---------------------	--------------------------

WSCAD Universe 769-104/021-000	URL	Download
--------------------------------	---------------------	--------------------------

EPLAN Data Portal 769-104/021-000	URL	Download
-----------------------------------	---------------------	--------------------------

WSCAD Universe 769-104/021-000	URL	Download
--------------------------------	---------------------	--------------------------

ZUKEN Portal 769-104/021-000	URL	Download
------------------------------	---------------------	--------------------------

Environmental Product Compliance

Compliance Search

Environmental Product Compliance 769-104/021-000	URL	Download
--	---------------------	--------------------------

1-conductor female connector; CAGE CLAMP®; 4 mm²; Pin spacing 5 mm; 4-pole; coding finger; Lateral locking levers; 4,00 mm²; gray

Installation Notes

Conductor termination

Subject to changes. Please also observe the further product documentation!

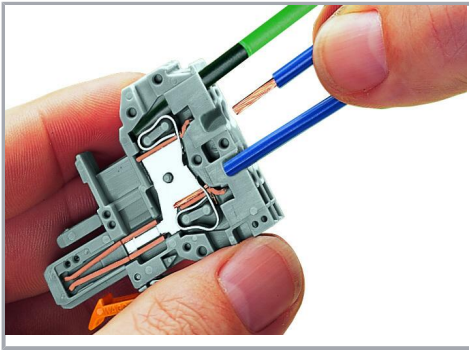

CAGE CLAMP® connection

Female plug: Inserting/removing a conductor via operating tool.

Operation 90° to conductor is also possible.

With ferruled conductors, it is necessary to use a terminal block one size smaller than the conductor's nominal cross-section.

Commoning

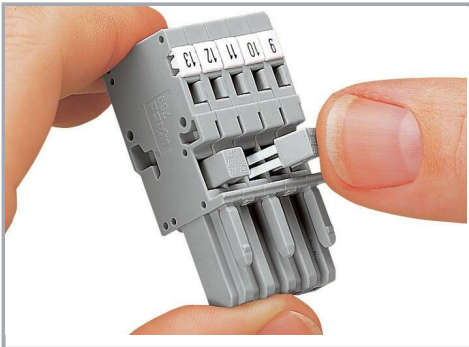

Commoning 1-conductor female plugs via miniature adjacent jumpers.

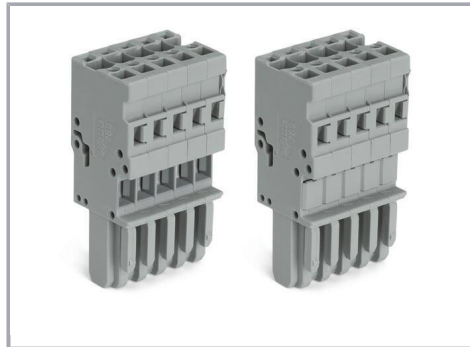

Jumper cover for 1-conductor female plugs

Coding

Subject to changes. Please also observe the further product documentation!



Coding a female plug by removing coding finger(s) via cutting tool. Do not remove the first and last coding fingers or use an additional locking lever.

Locking system

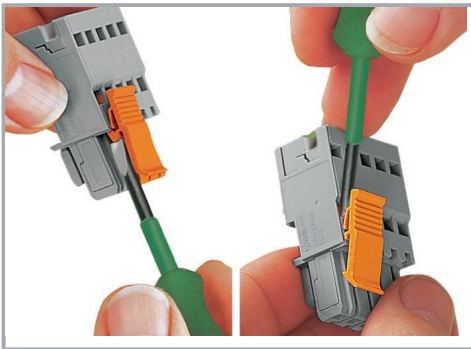

Locking/releasing a lever.

Strain relief

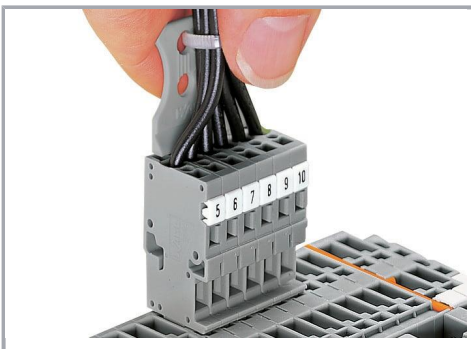

Removing a female plug via conductor bundle provided with strain relief plate.

Subject to changes. Please also observe the further product documentation!

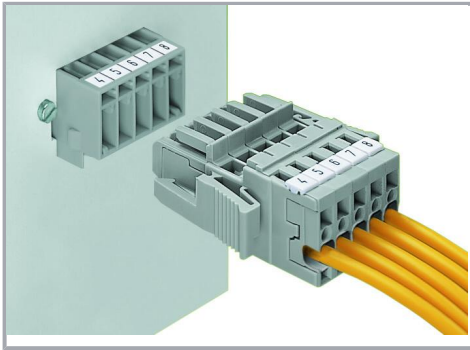

Male header with mounting flanges

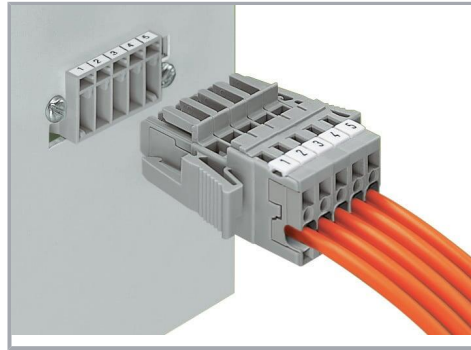

Male header and 1-conductor female plug with lateral locking levers

1-conductor female plug with lateral locking levers

Marking

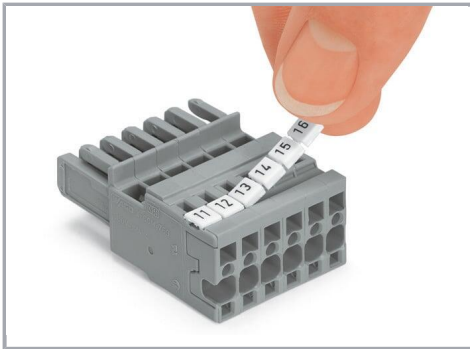

Labeling a female plug with CAGE CLAMP® connection via Mini-WSB Quick Markers.

Product family

X-COM

[Show all products from the family](#)

Subject to changes. Please also observe the further product documentation!