

# PXMBNI78FPF03AFLPG135002 Datasheet

**Product Name // 3 Contacts 7/8" Front Panel Mounting  
Female 200mm Flying Leads**

[View Product Page](#)

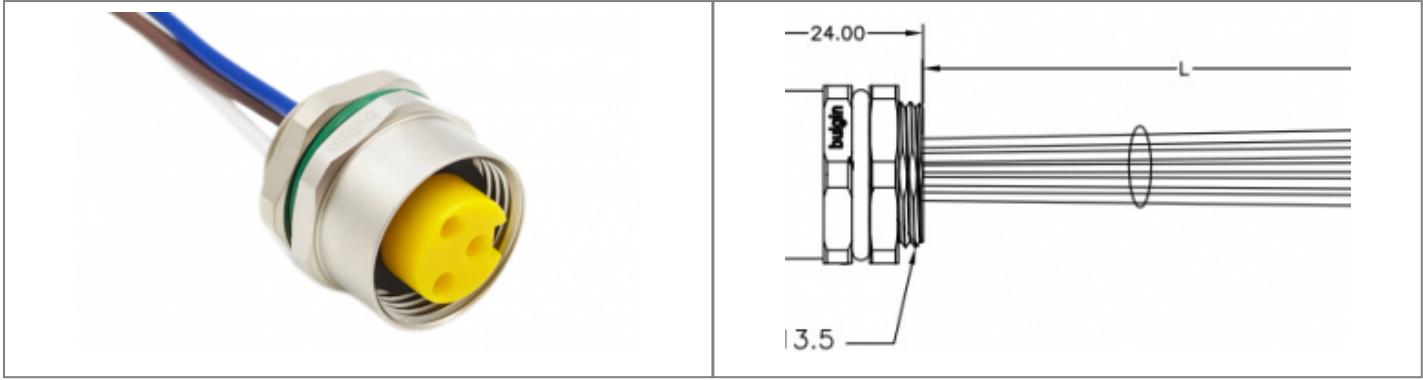

**// Product Description:**

- ⊕ 3 Contacts 7-8" Front Panel Mounting Female 0.2M Cable
- ⊕ IP67 rated when mated
- ⊕ Mechanical Cycles >100
- ⊕ Operating Temperature -25°C to +85°C
- ⊕ Rated Voltage 300 V
- ⊕ ROHS compliance

**// General Information:**

<p><b>Product Display Title:</b></p> <p><b>Product Family:</b></p> <p><b>Product Series:</b></p> <p><b>Cable Length:</b></p> <p><b>Connection Method:</b></p> <p><b>Contact Type:</b></p> <p><b>Current Max:</b></p> <p><b>Durability:</b></p> <p><b>Function:</b></p> <p><b>Insulation Resistance:</b></p> <p><b>Ip Rating:</b></p> <p><b>Max Operating Temperature:</b></p> <p><b>Min Operating Temperature:</b></p> <p><b>Number Of Contacts:</b></p> <p><b>Pin Layout Code:</b></p> <p><b>Rohs Compliant:</b></p> <p><b>Thread Size:</b></p> <p><b>Voltage Max:</b></p>	<p>7/8" Front Panel Mounting Female 200mm Flying Leads</p> <p>Circular Automation Connectors</p> <p>7/8" Series</p> <p>0.2m</p> <p>Solder</p> <p>Socket Contact</p> <p>12A</p> <p>&gt;100 Cycles</p> <p>Front Panel Mounting Female Connector with Flying Leads</p> <p>&gt;100MOhm</p> <p>IP67</p> <p>+80°C</p> <p>-25°C</p> <p>3 Contacts</p> <p>A Code</p> <p>Yes</p> <p>PG13.5</p> <p>300V</p>
---	---

**// Product PDF Links**

[78 Series Circular connectors...](#)