

$V_{CES}$	650V
$I_C$	25A
$V_{CE(sat)}$ (Typ.)	1.5V
$P_D$	165W

### ●Features

- 1) AEC-Q101 Qualified
- 2) Low Collector - Emitter Saturation Voltage
- 3) Low Switching Loss & Soft Switching
- 4) Built in Very Fast & Soft Recovery FRD
- 5) Pb - free Lead Plating ; RoHS Compliant

### ●Application

- Automotive
- On & Off Board Chargers
- DC-DC Converters
- PFC
- Industrial Inverter

### ●Outline

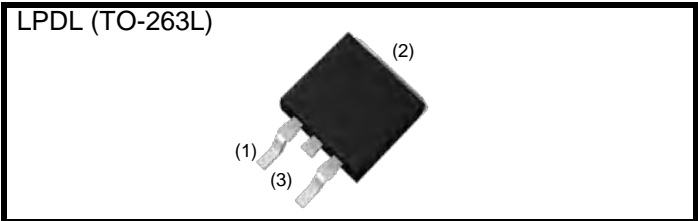

### ●Inner Circuit

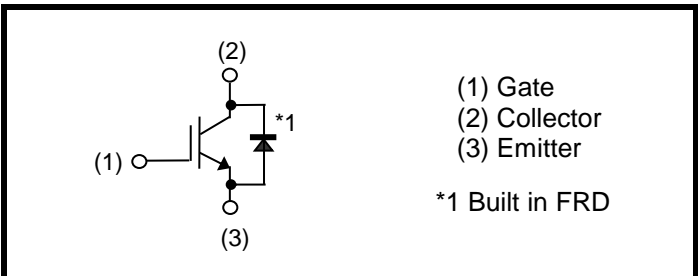

### ●Packaging Specifications

Type	Packaging	Taping
	Reel Size (mm)	330
	Tape Width (mm)	24
	Basic Ordering Unit (pcs)	1,000
	Packing Code	TL
	Marking	RGW50NL65D

### ●Absolute Maximum Ratings (at $T_C = 25^\circ\text{C}$ unless otherwise specified)

Parameter	Symbol	Value	Unit
Collector - Emitter Voltage	$V_{CES}$	650	V
Gate - Emitter Voltage	$V_{GES}$	$\pm 30$	V
Collector Current	$T_C = 25^\circ\text{C}$	$I_C$	57 A
	$T_C = 100^\circ\text{C}$	$I_C$	35 A
Pulsed Collector Current	$I_{CP}^{*1}$	100	A
Diode Forward Current	$T_C = 25^\circ\text{C}$	$I_F$	24 A
	$T_C = 100^\circ\text{C}$	$I_F$	14 A
Diode Pulsed Forward Current	$I_{FP}^{*1}$	100	A
Power Dissipation	$T_C = 25^\circ\text{C}$	$P_D$	165 W
	$T_C = 100^\circ\text{C}$	$P_D$	82 W
Operating Junction Temperature	$T_j$	-40 to +175	$^\circ\text{C}$
Storage Temperature	$T_{stg}$	-55 to +175	$^\circ\text{C}$

\*1 Pulse width limited by  $T_{jmax}$ .

### ●Thermal Resistance

Parameter	Symbol	Values			Unit
		Min.	Typ.	Max.	
Thermal Resistance IGBT Junction - Case	$R_{\theta(j-c)}$	-	-	0.91	°C/W
Thermal Resistance Diode Junction - Case	$R_{\theta(j-c)}$	-	-	2.61	°C/W

### ●IGBT Electrical Characteristics (at $T_j = 25^\circ\text{C}$ unless otherwise specified)

Parameter	Symbol	Conditions	Values			Unit
			Min.	Typ.	Max.	
Collector - Emitter Breakdown Voltage	$BV_{CES}$	$I_C = 10\mu\text{A}$ , $V_{GE} = 0\text{V}$	650	-	-	V
Collector Cut - off Current	$I_{CES}$	$V_{CE} = 650\text{V}$ , $V_{GE} = 0\text{V}$	-	-	10	$\mu\text{A}$
Gate - Emitter Leakage Current	$I_{GES}$	$V_{GE} = \pm 30\text{V}$ , $V_{CE} = 0\text{V}$	-	-	$\pm 200$	nA
Gate - Emitter Threshold Voltage	$V_{GE(th)}$	$V_{CE} = 5\text{V}$ , $I_C = 16.4\text{mA}$	5.0	6.0	7.0	V
Collector - Emitter Saturation Voltage	$V_{CE(sat)}$	$I_C = 25\text{A}$ , $V_{GE} = 15\text{V}$ , $T_j = 25^\circ\text{C}$	-	1.5	1.9	V
		$T_j = 175^\circ\text{C}$	-	1.85	-	

●IGBT Electrical Characteristics (at  $T_j = 25^\circ\text{C}$  unless otherwise specified)

Parameter	Symbol	Conditions	Values			Unit
			Min.	Typ.	Max.	
Input Capacitance	$C_{ies}$	$V_{CE} = 30\text{V}$ ,	-	2080	-	pF
Output Capacitance	$C_{oes}$	$V_{GE} = 0\text{V}$ ,	-	56	-	
Reverse transfer Capacitance	$C_{res}$	$f = 1\text{MHz}$	-	38	-	
Total Gate Charge	$Q_g$	$V_{CE} = 400\text{V}$ ,	-	73	-	nC
Gate - Emitter Charge	$Q_{ge}$	$I_C = 25\text{A}$ ,	-	15	-	
Gate - Collector Charge	$Q_{gc}$	$V_{GE} = 15\text{V}$	-	28	-	
Turn - on Delay Time	$t_{d(on)}$	$I_C = 12.5\text{A}$ , $V_{CC} = 400\text{V}$ , $V_{GE} = 15\text{V}$ , $R_G = 10\Omega$ , $T_j = 25^\circ\text{C}$ Inductive Load * $E_{on}$ include diode reverse recovery	-	31	-	ns
Rise Time	$t_r$		-	7	-	
Turn - off Delay Time	$t_{d(off)}$		-	119	-	
Fall Time	$t_f$		-	42	-	
Turn - on Switching Loss	$E_{on}$		-	0.11	-	mJ
Turn - off Switching Loss	$E_{off}$		-	0.23	-	
Turn - on Delay Time	$t_{d(on)}$	$I_C = 12.5\text{A}$ , $V_{CC} = 400\text{V}$ , $V_{GE} = 15\text{V}$ , $R_G = 10\Omega$ , $T_j = 175^\circ\text{C}$ Inductive Load * $E_{on}$ include diode reverse recovery	-	30	-	ns
Rise Time	$t_r$		-	7	-	
Turn - off Delay Time	$t_{d(off)}$		-	130	-	
Fall Time	$t_f$		-	64	-	
Turn - on Switching Loss	$E_{on}$		-	0.12	-	mJ
Turn - off Switching Loss	$E_{off}$		-	0.28	-	
Reverse Bias Safe Operating Area	RBSOA	$I_C = 100\text{A}$ , $V_{CC} = 520\text{V}$ , $V_P = 650\text{V}$ , $V_{GE} = 15\text{V}$ , $R_G = 100\Omega$ , $T_j = 175^\circ\text{C}$	FULL SQUARE			-

●FRD Electrical Characteristics (at  $T_j = 25^\circ\text{C}$  unless otherwise specified)

Parameter	Symbol	Conditions	Values			Unit
			Min.	Typ.	Max.	
Diode Forward Voltage	$V_F$	$I_F = 12\text{A}$ , $T_j = 25^\circ\text{C}$ $T_j = 175^\circ\text{C}$	-	1.5	1.95	V
			-	1.6	-	
Diode Reverse Recovery Time	$t_{rr}$	$I_F = 12.5\text{A}$ , $V_{CC} = 400\text{V}$ , $di_F/dt = 200\text{A}/\mu\text{s}$ , $T_j = 25^\circ\text{C}$	-	71	-	ns
Diode Peak Reverse Recovery Current	$I_{rr}$		-	5.3	-	A
Diode Reverse Recovery Charge	$Q_{rr}$		-	0.21	-	$\mu\text{C}$
Diode Reverse Recovery Energy	$E_{rr}$		-	8.3	-	$\mu\text{J}$
Diode Reverse Recovery Time	$t_{rr}$		-	87	-	ns
Diode Peak Reverse Recovery Current	$I_{rr}$	$I_F = 12.5\text{A}$ , $V_{CC} = 400\text{V}$ , $di_F/dt = 200\text{A}/\mu\text{s}$ , $T_j = 175^\circ\text{C}$	-	5.8	-	A
Diode Reverse Recovery Charge	$Q_{rr}$		-	0.27	-	$\mu\text{C}$
Diode Reverse Recovery Energy	$E_{rr}$		-	11.8	-	$\mu\text{J}$

●Electrical Characteristic Curves

Fig.1 Power Dissipation vs. Case Temperature

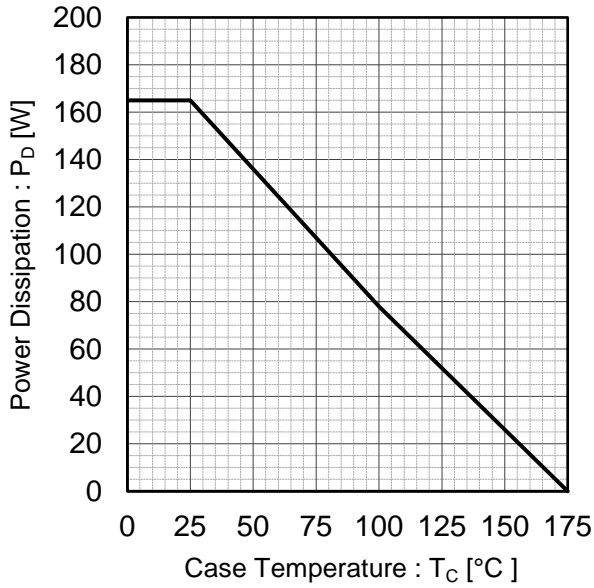

Fig.2 Collector Current vs. Case Temperature

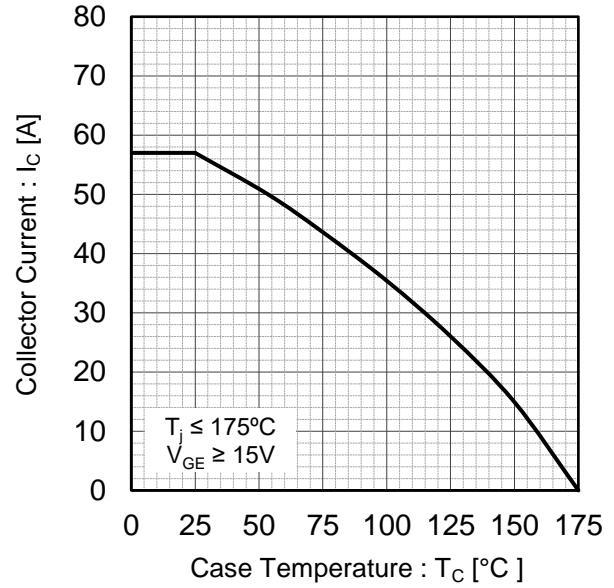

Fig.3 Forward Bias Safe Operating Area

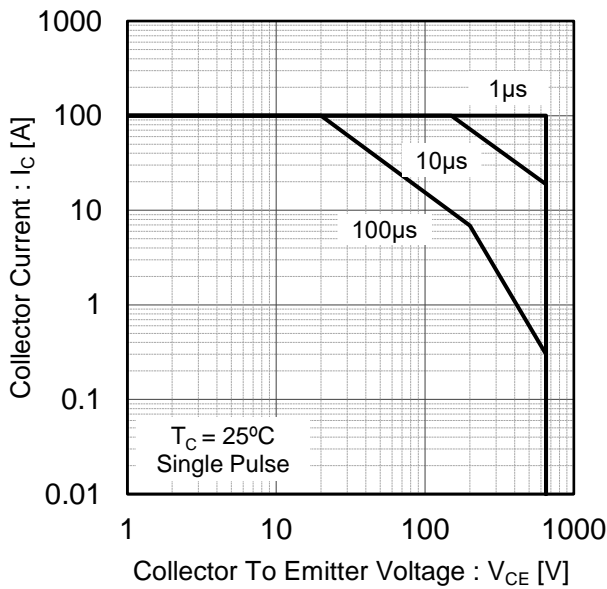
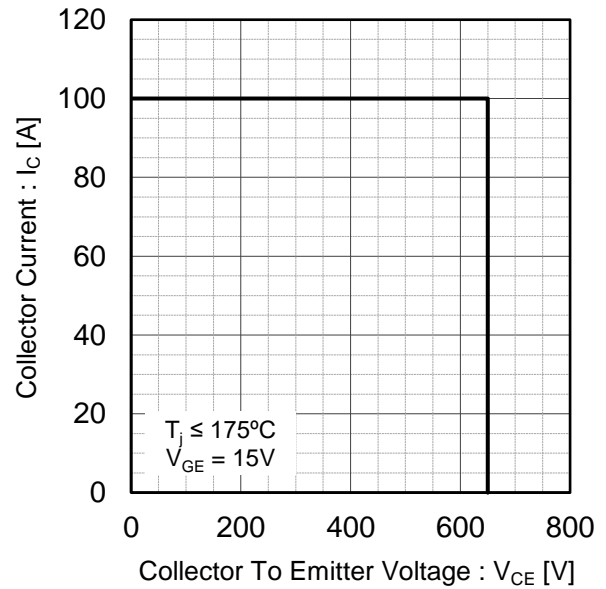

Fig.4 Reverse Bias Safe Operating Area



●Electrical Characteristic Curves

Fig.5 Typical Output Characteristics

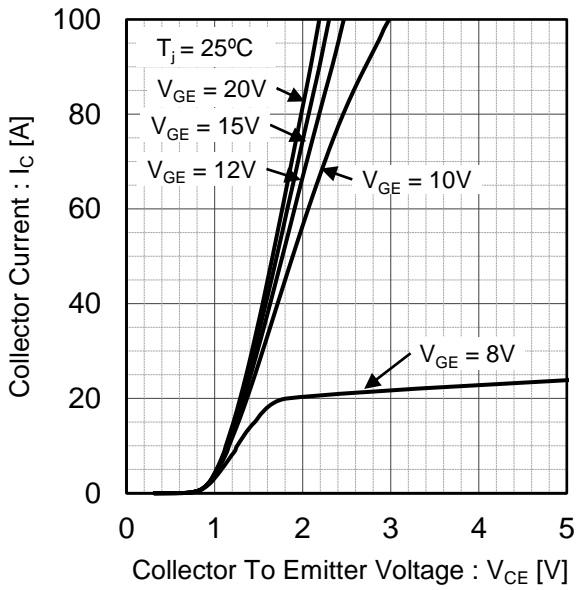

Fig.6 Typical Output Characteristics

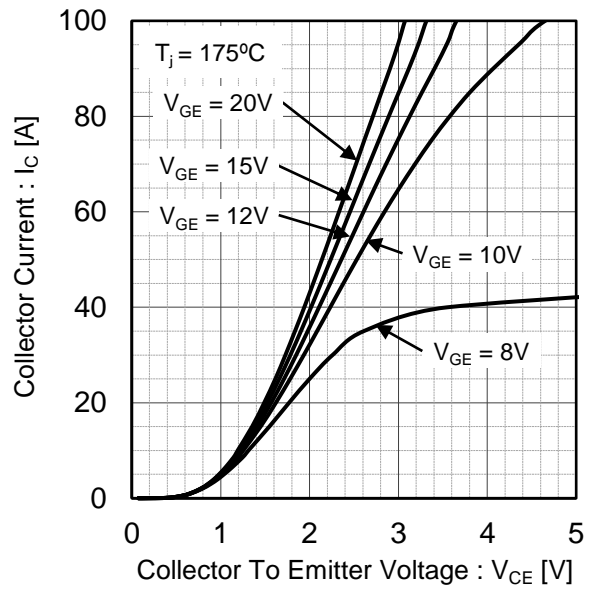

Fig.7 Typical Transfer Characteristics

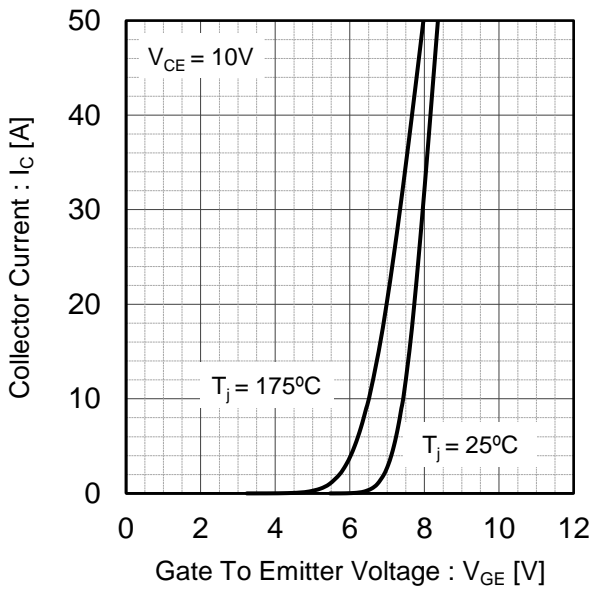
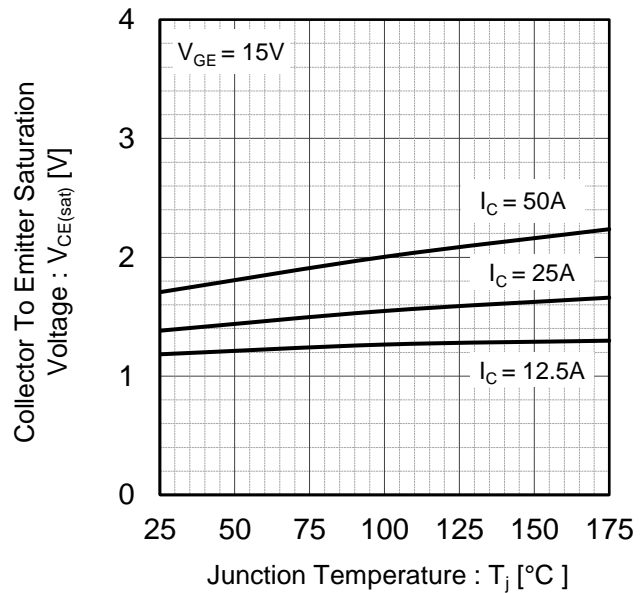

Fig.8 Typical Collector to Emitter Saturation Voltage vs. Junction Temperature



●Electrical Characteristic Curves

Fig.9 Typical Collector to Emitter Saturation Voltage vs. Gate to Emitter Voltage

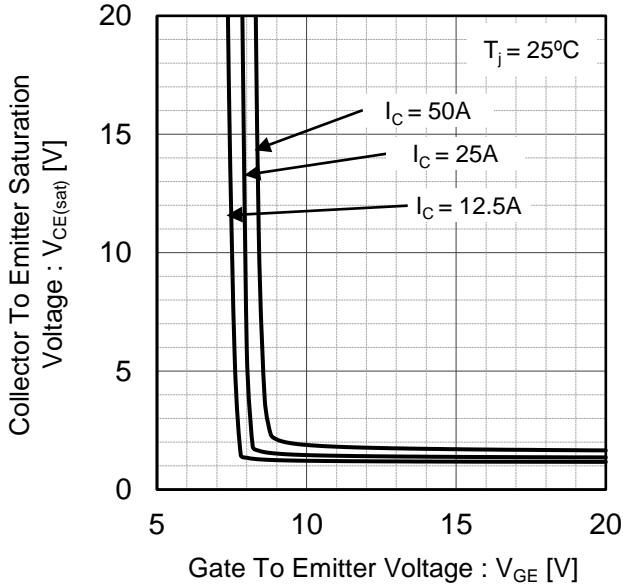

Fig.10 Typical Collector to Emitter Saturation Voltage vs. Gate to Emitter Voltage

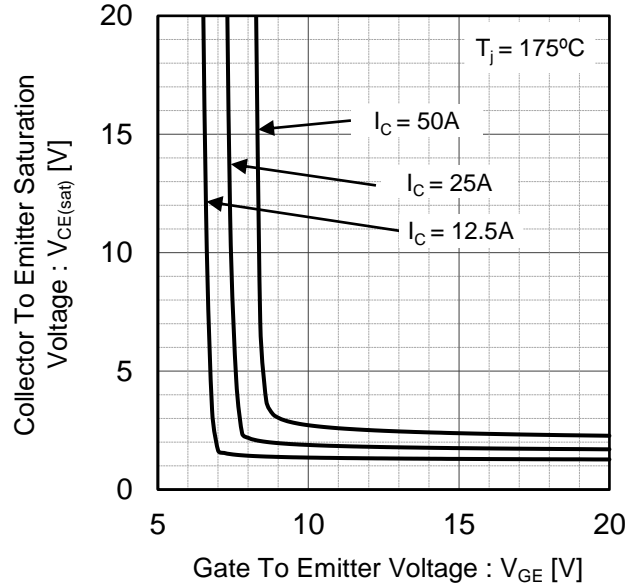

Fig.11 Typical Capacitance vs. Collector to Emitter Voltage

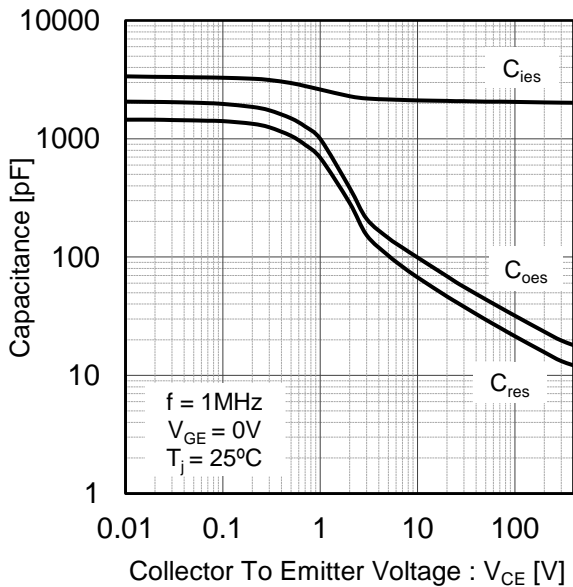
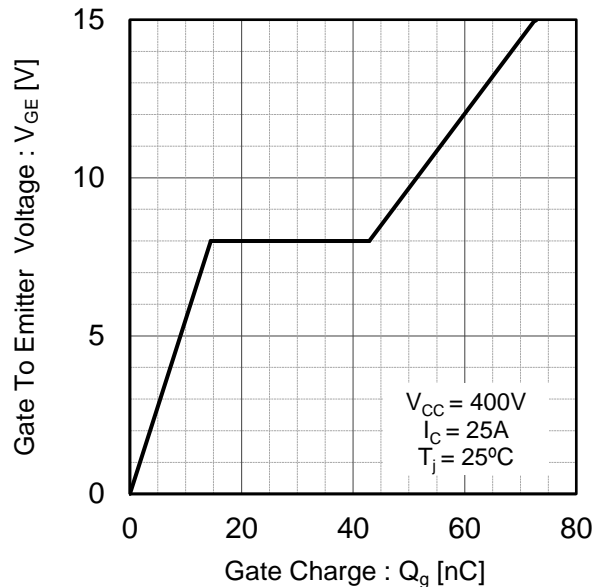

Fig.12 Typical Gate Charge



●Electrical Characteristic Curves

Fig.13 Typical Switching Time vs. Collector Current

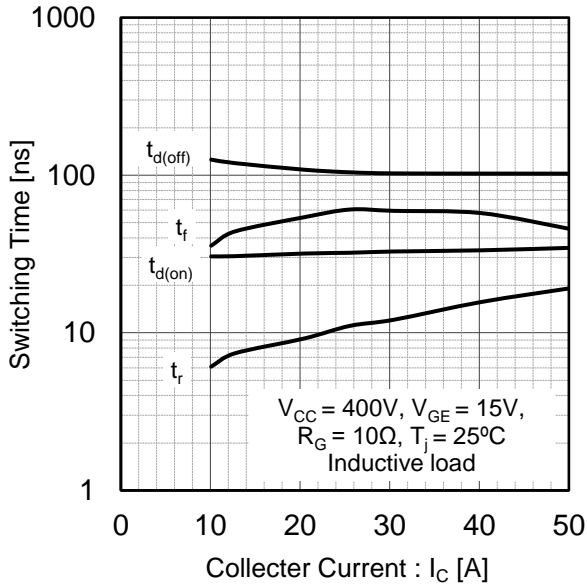

Fig.14 Typical Switching Time vs. Gate Resistance

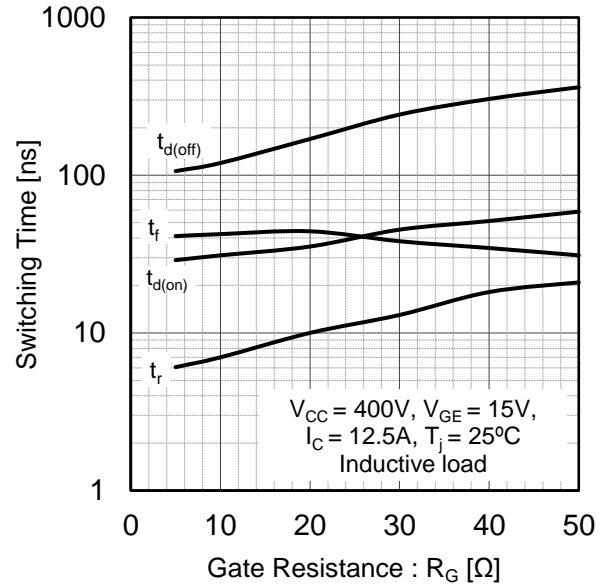

Fig.15 Typical Switching Energy Losses vs. Collector Current

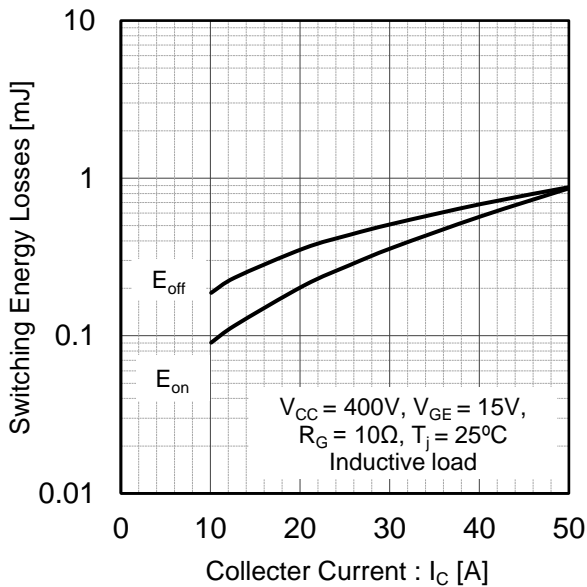
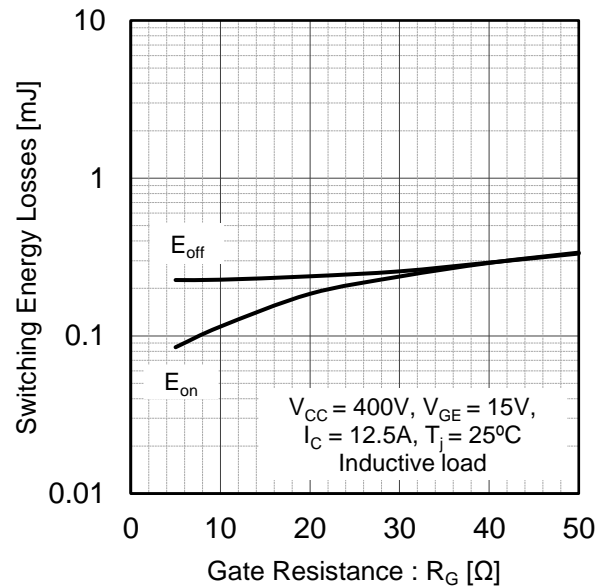

Fig.16 Typical Switching Energy Losses vs. Gate Resistance





●Electrical Characteristic Curves

Fig.17 Typical Switching Time vs. Collector Current

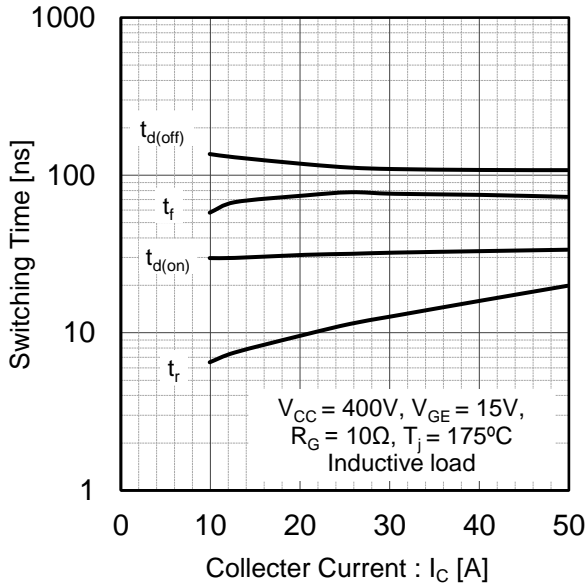

Fig.18 Typical Switching Time vs. Gate Resistance

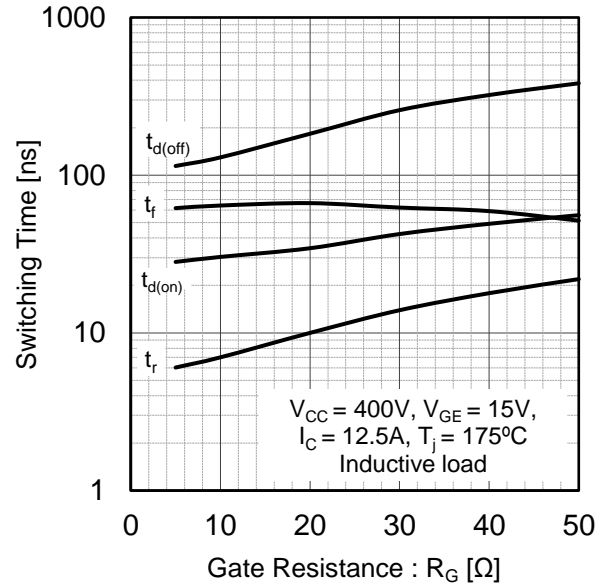

Fig.19 Typical Switching Energy Losses vs. Collector Current

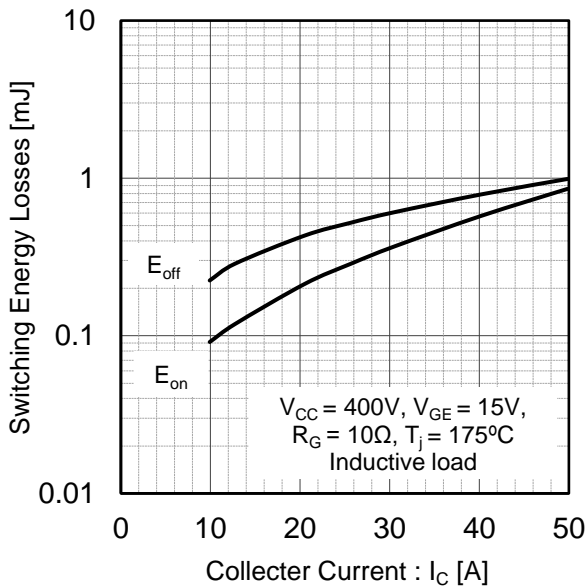
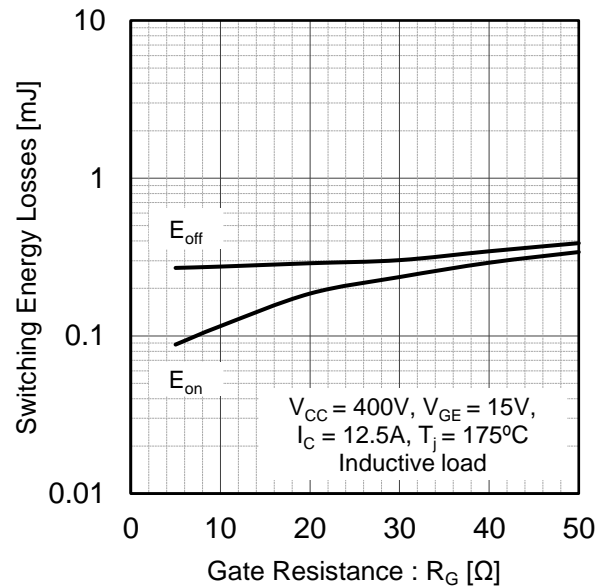

Fig.20 Typical Switching Energy Losses vs. Gate Resistance



●Electrical Characteristic Curves

Fig.21 Typical Diode Forward Current vs. Forward Voltage

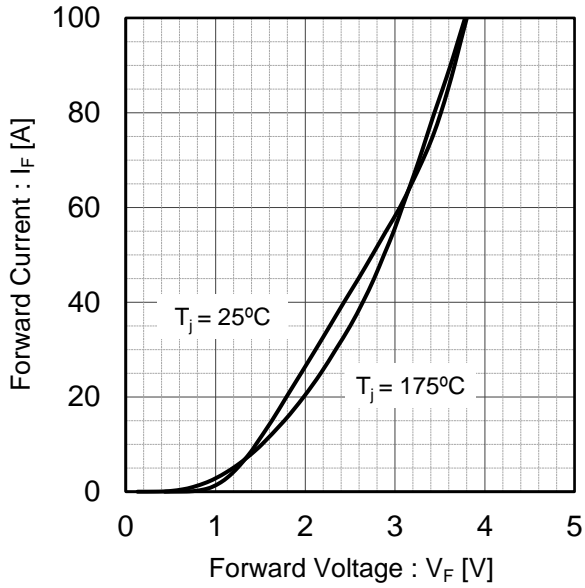

Fig.22 Typical Diode Reverse Recovery Time vs. Forward Current

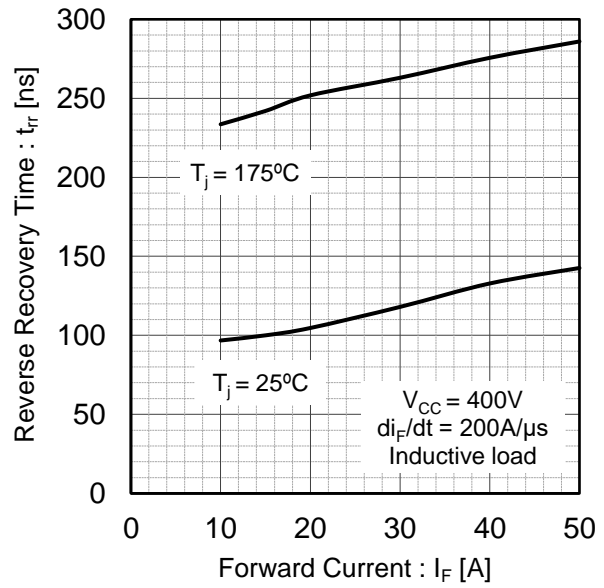

Fig.23 Typical Diode Reverse Recovery Current vs. Forward Current

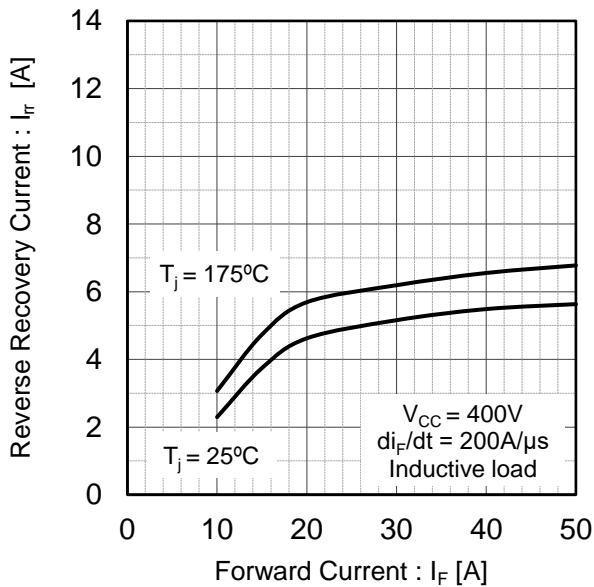
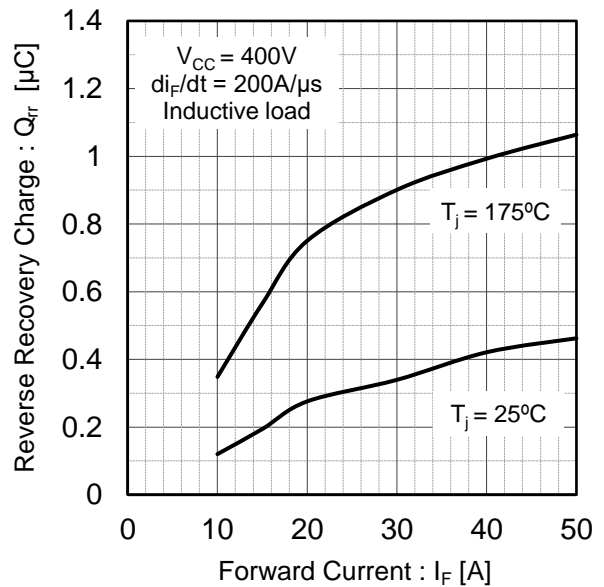

Fig.24 Typical Diode Reverse Recovery Charge vs. Forward Current



●Electrical Characteristic Curves

Fig.25 Typical IGBT Transient Thermal Impedance

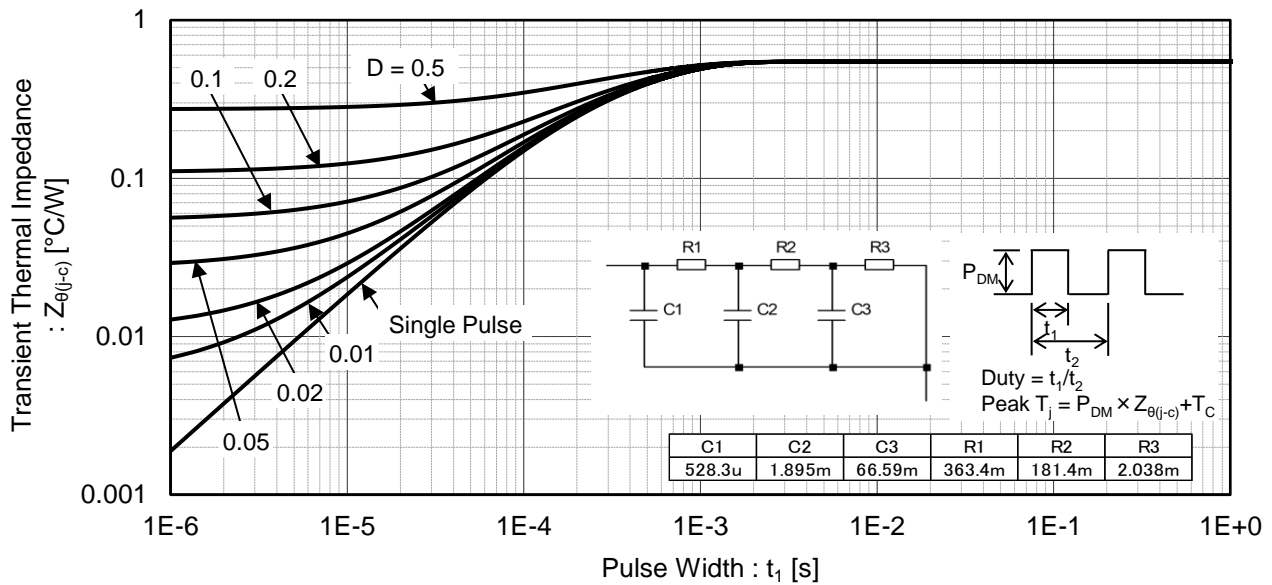
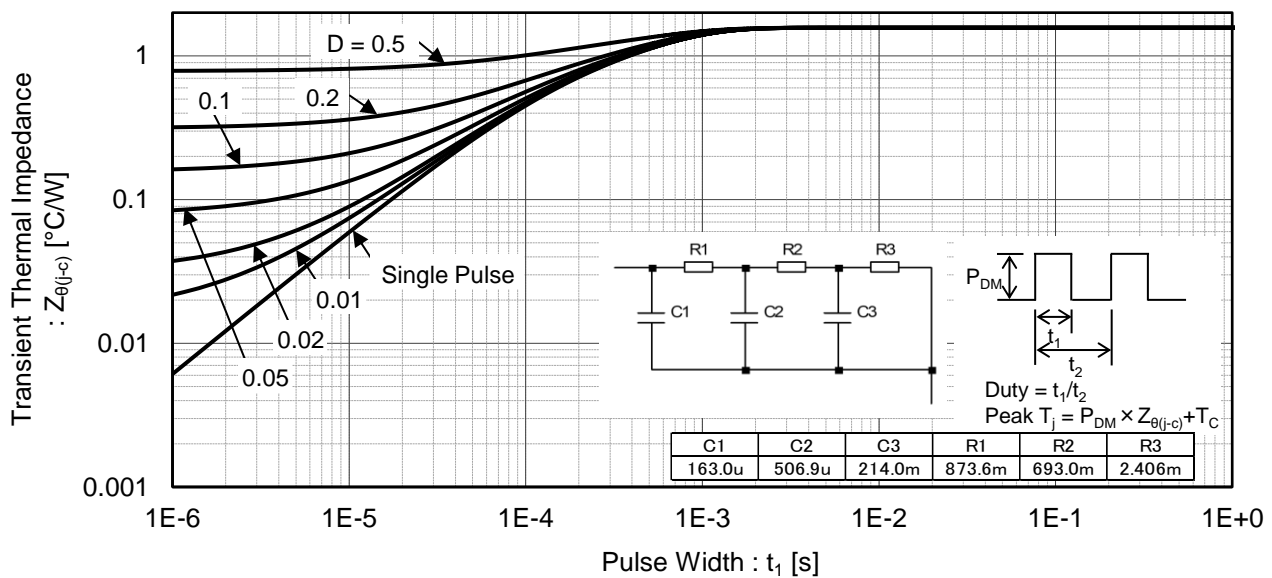

Fig.26 Typical Diode Transient Thermal Impedance



● Inductive Load Switching Circuit and Waveform

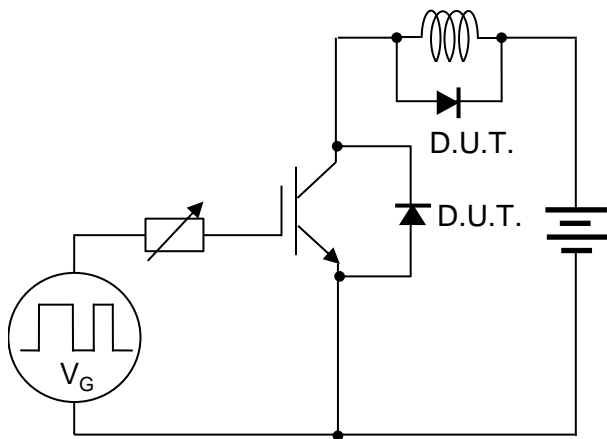

Fig.27 Inductive Load Circuit

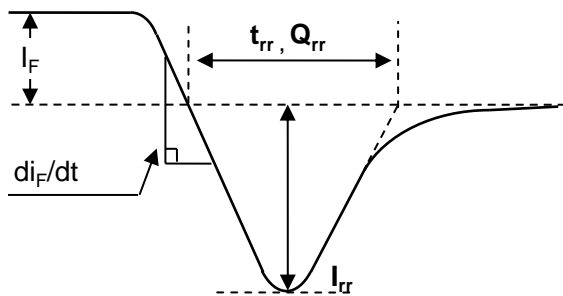

Fig.29 Diode Reverse Recovery Waveform

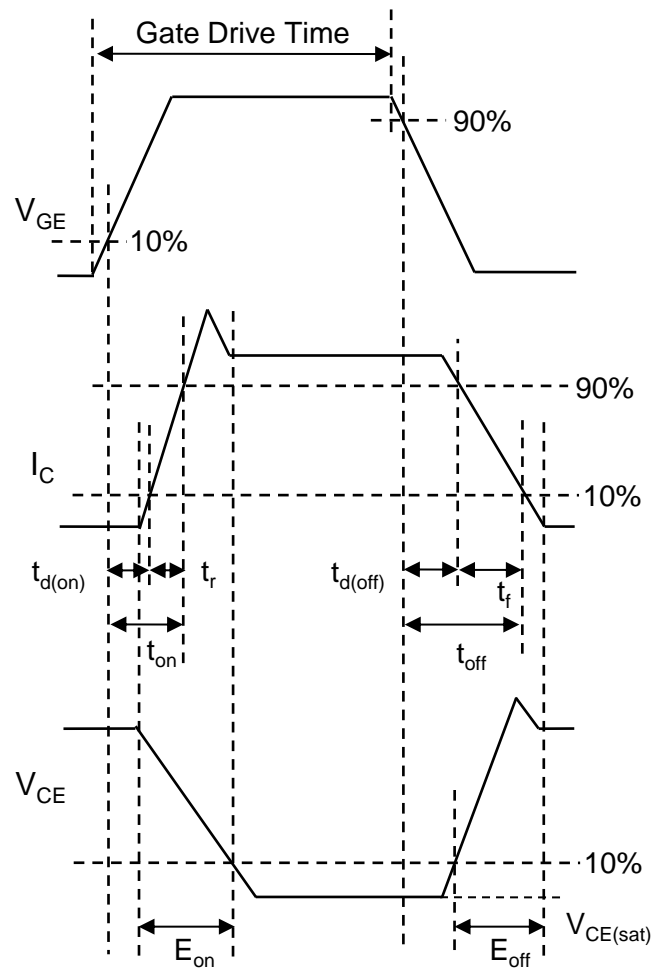

Fig.28 Inductive Load Waveform

## Notes

- 1) The information contained herein is subject to change without notice.
- 2) Before you use our Products, please contact our sales representative and verify the latest specifications.
- 3) Although ROHM is continuously working to improve product reliability and quality, semiconductors can break down and malfunction due to various factors. Therefore, in order to prevent personal injury or fire arising from failure, please take safety measures such as complying with the derating characteristics, implementing redundant and fire prevention designs, and utilizing backups and fail-safe procedures. ROHM shall have no responsibility for any damages arising out of the use of our Products beyond the rating specified by ROHM.
- 4) Examples of application circuits, circuit constants and any other information contained herein are provided only to illustrate the standard usage and operations of the Products. The peripheral conditions must be taken into account when designing circuits for mass production.
- 5) The technical information specified herein is intended only to show the typical functions of and examples of application circuits for the Products. ROHM does not grant you, explicitly or implicitly, any license to use or exercise intellectual property or other rights held by ROHM or any other parties. ROHM shall have no responsibility whatsoever for any dispute arising out of the use of such technical information.
- 6) The Products specified in this document are not designed to be radiation tolerant.
- 7) For use of our Products in applications requiring a high degree of reliability (as exemplified below), please contact and consult with a ROHM representative : transportation equipment (i.e. cars, ships, trains), primary communication equipment, traffic lights, fire/crime prevention, safety equipment, medical systems, and power transmission systems.
- 8) Do not use our Products in applications requiring extremely high reliability, such as aerospace equipment, nuclear power control systems, and submarine repeaters.
- 9) ROHM shall have no responsibility for any damages or injury arising from non-compliance with the recommended usage conditions and specifications contained herein.
- 10) ROHM has used reasonable care to ensure the accuracy of the information contained in this document. However, ROHM does not warrants that such information is error-free, and ROHM shall have no responsibility for any damages arising from any inaccuracy or misprint of such information.
- 11) Please use the Products in accordance with any applicable environmental laws and regulations, such as the RoHS Directive. For more details, including RoHS compatibility, please contact a ROHM sales office. ROHM shall have no responsibility for any damages or losses resulting non-compliance with any applicable laws or regulations.
- 12) When providing our Products and technologies contained in this document to other countries, you must abide by the procedures and provisions stipulated in all applicable export laws and regulations, including without limitation the US Export Administration Regulations and the Foreign Exchange and Foreign Trade Act.
- 13) This document, in part or in whole, may not be reprinted or reproduced without prior consent of ROHM.



Thank you for your accessing to ROHM product informations.  
More detail product informations and catalogs are available, please contact us.

## ROHM Customer Support System

<http://www.rohm.com/contact/>

**General Precaution**

1. Before you use our Products, you are requested to carefully read this document and fully understand its contents. ROHM shall not be in any way responsible or liable for failure, malfunction or accident arising from the use of any ROHM's Products against warning, caution or note contained in this document.
2. All information contained in this document is current as of the issuing date and subject to change without any prior notice. Before purchasing or using ROHM's Products, please confirm the latest information with a ROHM sales representative.
3. The information contained in this document is provided on an "as is" basis and ROHM does not warrant that all information contained in this document is accurate and/or error-free. ROHM shall not be in any way responsible or liable for any damages, expenses or losses incurred by you or third parties resulting from inaccuracy or errors of or concerning such information.