

THIS DOCUMENT IS SUBJECT TO CHANGE WITHOUT NOTICE. IT IS CONFIDENTIAL AND A PROPERTY OF Amphenol LTW. DISCLOSURE TO THIRD PARTY HAS TO BE AUTHORIZED BY Amphenol LTW.

REV.	ECN NO.	DATE	SIGN	DESCRIPTION
E	C201447	2020/09/18	Ruru	△E X6
F	C210309	2021/02/23	Ruru	△F X3
G	C221973	2022/12/21	Ruru	△G X1

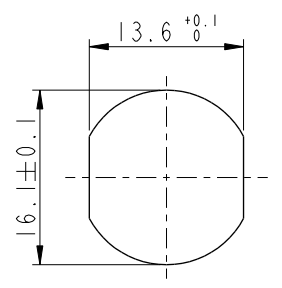

Recommended Panel Cut-Out



M12A-XXPFFP-SF8002

XX: No. Of Pin

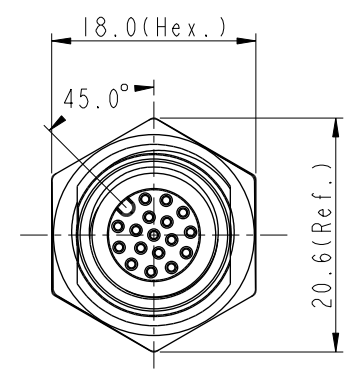
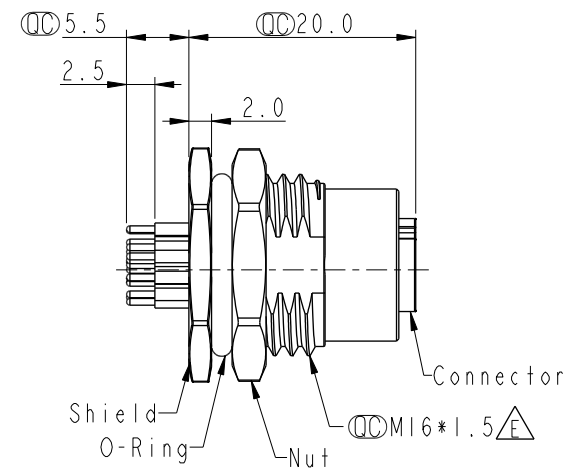
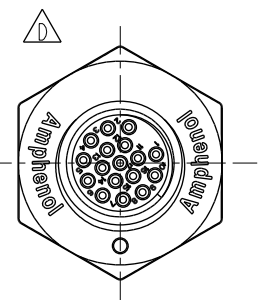

- △F △E Note:**
- * RoHS Compliant
 - * ⌀ Important dimension
 - △G △C** * Waterproof rate: IP68, unmated 1m/24h
IP69K, unmated
 - * Connector
Housing: Thermoplastic, Black
Pin: Copper alloy, Gold plated
O-Ring: Rubber, Green
 - * Shield: Metal
 - * Nut: Metal
 - * O-Ring: Rubber, Black
 - * For panel thickness max: 4.5mm
 - * Nut is packed separately in pe bag

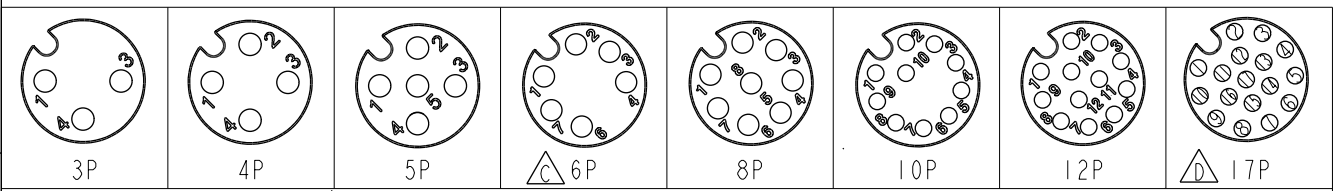





Pin Assignment Front View

UNIT: mm			TITLE N SEN, M12 A, SCREW RECEPTACLE, F, F, PCB S △E
TOLERANCE .X ±0.25 .XX ±0.1 .XXX ±0.05 ANGLES ±1°	SCALE 2:1	SIZE A4	SHEET 1 OF 2
	REV. G	WC-REV. A.5	⌀ : Inspection item

Amphenol LTW
安費諾亮泰企業股份有限公司

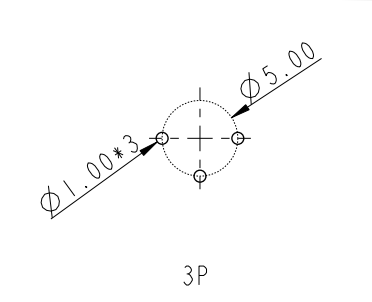
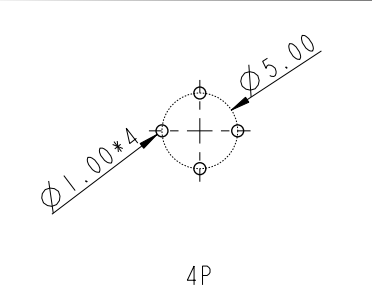
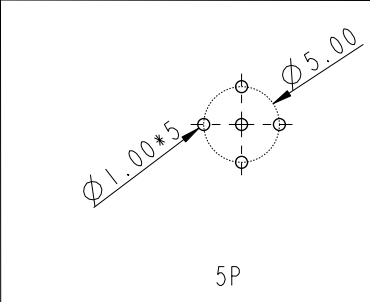
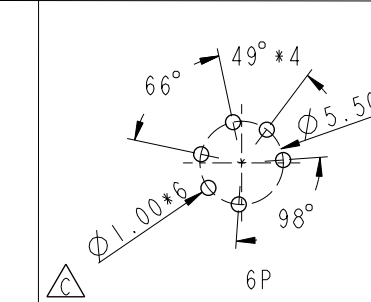
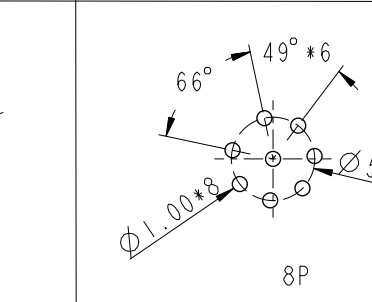
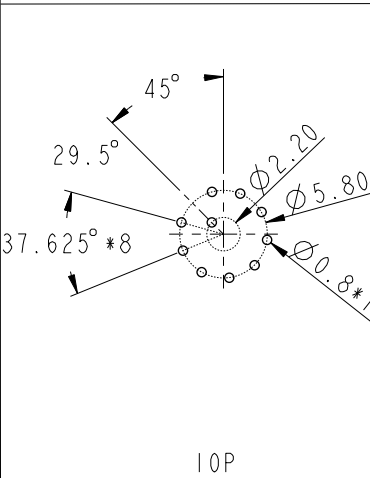
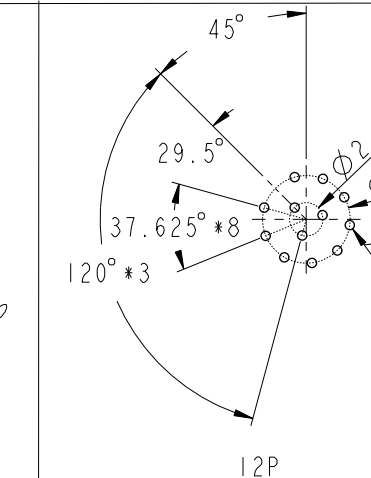
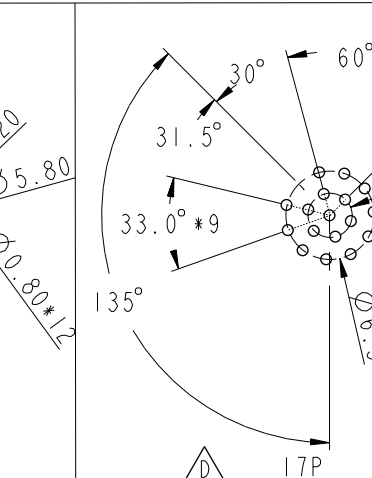
ITEM NO	DRAWN BY Yulong_wang	DATE 2016-08-08
DWG NO △E M12A-XXPFFP-SF8002	CHECKED BY Jinhai	DATE 2016-08-08
CUSTOMER ALTW	APPROVED BY Jerry	DATE 2016-08-08

THIS DOCUMENT IS SUBJECT TO CHANGE WITHOUT NOTICE. IT IS CONFIDENTIAL AND A PROPERTY OF Amphenol LTW. DISCLOSURE TO THIRD PARTY HAS TO BE AUTHORIZED BY Amphenol LTW.

F		2	3	4	5	6	7	8		
E										
D	PCB Layout									
C	 <p style="text-align: center;">3P</p>		 <p style="text-align: center;">4P</p>		 <p style="text-align: center;">5P</p>		 <p style="text-align: center;">6P</p>		 <p style="text-align: center;">8P</p>	
B	 <p style="text-align: center;">10P</p>				 <p style="text-align: center;">12P</p>			 <p style="text-align: center;">17P</p>		
A	UNIT: mm  	TITLE N SEN, M12 A, SCREW RECEPTACLE, F, F, PCB S 			<h1 style="margin: 0;">Amphenol LTW</h1> <h2 style="margin: 0;">安費諾亮泰企業股份有限公司</h2>			ITEM NO M12A-XXPFFP-SF8002	DRAWN BY Yulong_wang	DATE 2016-08-08
TOLERANCE .X ±0.25 .XX ±0.1 .XXX ±0.05 ANGLES ±1°		SCALE 2:1	SIZE A4	SHEET 2 OF 2	REV. G WC-REV. A.4  Inspection item			CHECKED BY Jinhai	DATE 2016-08-08	
					CUSTOMER ALTW			APPROVED BY Jerry	DATE 2016-08-08	
	2	3	4	5	6	7	8	W10814-03-01A2		