

THIS DOCUMENT IS SUBJECT TO CHANGE WITHOUT NOTICE. IT IS CONFIDENTIAL AND A PROPERTY OF Amphenol LTW. DISCLOSURE TO THIRD PARTY HAS TO BE AUTHORIZED BY Amphenol LTW.

REV.	ECN NO.	DATE	SIGN	DESCRIPTION
F	C210023	2021/01/14	Vicky	△F X2
G	C210309	2021/02/24	Ruru	△G X3
H	C221973	2022/12/21	Ruru	△H X1

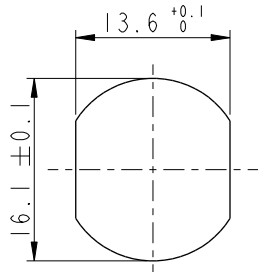

Recommended Panel Cut-Out

△B

△E

M12A-XXPMPM-SF8002

XX: No. Of Pin

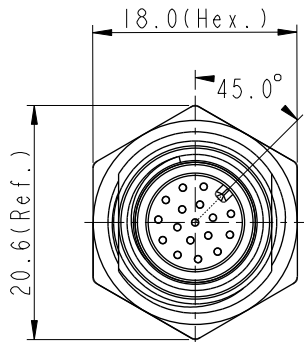
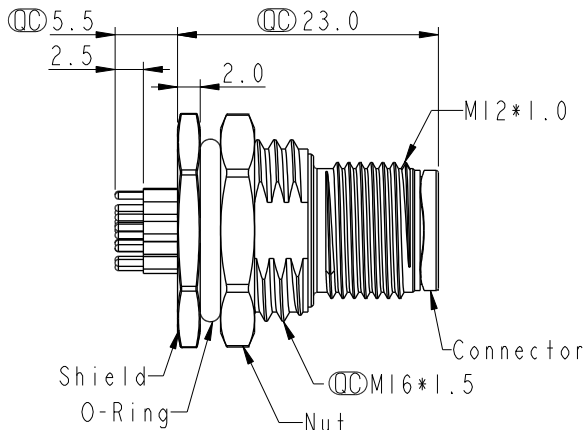
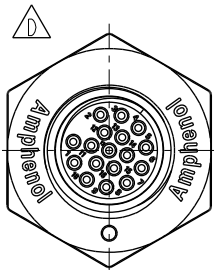

- △E △G Note:
- * RoHS Compliant
 - * ⌀ Important dimension
 - △H △C * Waterproof rate: IP68, unmated 1m/24h IP69K, unmated
 - * Connector
 - Housing: Thermoplastic, Black
 - Pin: Copper alloy, Gold plated
 - △E * Shield: Metal
 - △E * Nut: Metal
 - * O-Ring: Rubber, Black
 - * For panel thickness max: 4.5mm
 - * Nut is packed separately in pe bag

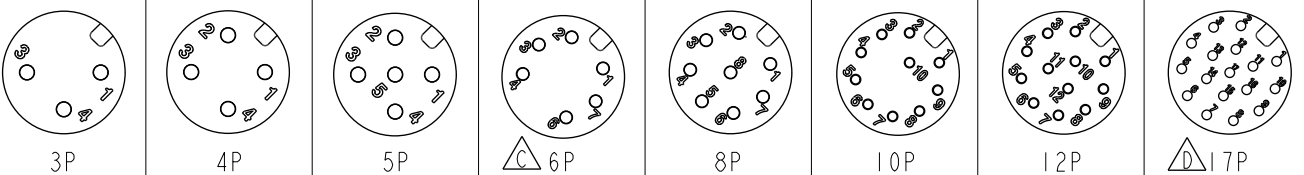







Pin Assignment Front View

UNIT: mm		TITLE N SEN, M12 A, SCREW RECEPTACLE, M, M, PCB S △G
TOLERANCE .X ±0.25 .XX ±0.1 .XXX ±0.05 ANGLES ±1°	SCALE 2:1	SIZE A4
	REV. H	SHEET 1 OF 2
	WC-REV. A.5	⌀ Inspection item

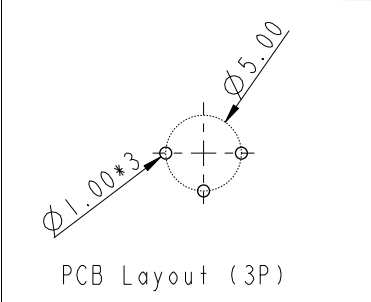
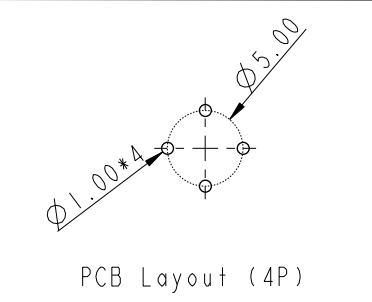
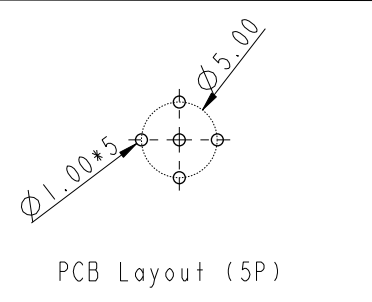
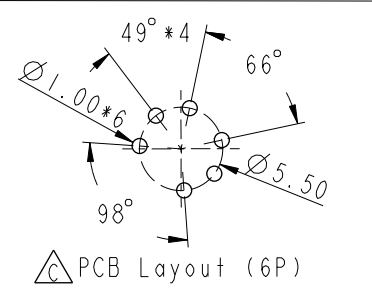
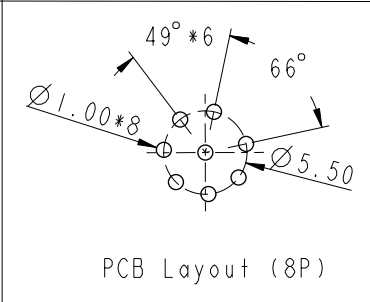
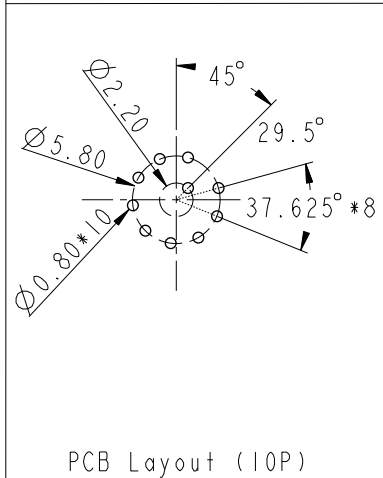
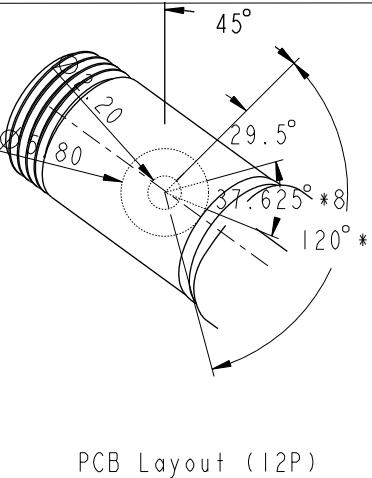
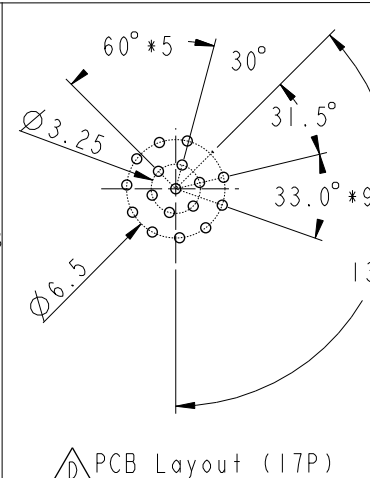
Amphenol LTW
安費諾亮泰企業股份有限公司

ITEM NO	DRAWN BY Yulong_wang	DATE 2016-08-08
DWG NO △E M12A-XXPMPM-SF8002	CHECKED BY Jinhai	DATE 2016-08-08
CUSTOMER ALTW	APPROVED BY Jerry	DATE 2016-08-08

THIS DOCUMENT IS SUBJECT TO CHANGE WITHOUT NOTICE. IT IS CONFIDENTIAL AND A PROPERTY OF Amphenol LTW. DISCLOSURE TO THIRD PARTY HAS TO BE AUTHORIZED BY Amphenol LTW.

F		2	3	4	5	6	7	8	
E									
D									
C									
B	 <p>PCB Layout (3P)</p>	 <p>PCB Layout (4P)</p>	 <p>PCB Layout (5P)</p>	 <p>PCB Layout (6P)</p>	 <p>PCB Layout (8P)</p>	 <p>PCB Layout (10P)</p>	 <p>PCB Layout (12P)</p>	 <p>PCB Layout (17P)</p>	
A	UNIT: mm  		TITLE N SEN, M12 A, SCREW RECEPTACLE, M, M, PCB S 		<h1 style="margin: 0;">Amphenol LTW</h1> <h2 style="margin: 0;">安費諾亮泰企業股份有限公司</h2>		ITEM NO M12A-XXPMMP-SF8002	DRAWN BY Yulong_wang	DATE 2016-08-08
TOLERANCE .X ±0.25 .XX ±0.1 .XXX ±0.05 ANGLES ±1°		SCALE 2:1	SIZE A4	SHEET 2 OF 2	DWG NO  M12A-XXPMMP-SF8002		CHECKED BY Jinhai	DATE 2016-08-08	
		REV. H	WC-REV. A.4	 Inspection item	CUSTOMER ALTW		APPROVED BY Jerry	DATE 2016-08-08	
	2	3	4	5	6	7	8	W10814-03-01A2	