

EVAL_MA5302MS_200Wx2

MA5302MS Evaluation Board



About this document

Scope and purpose

The EVAL_MA5302MS_200x2 evaluation board is a two-channel, 200 W/ch ($2\ \Omega$ at $\pm 28.5\text{ V}$; with heatsink) half-bridge class D audio power amplifier for Hi-Fi audio systems. This evaluation board demonstrates how to use MA5302MS IC, implement protection circuits, and design an optimum PCB layout using Infineon integrated Class D IC. This reference design does not require additional heatsink or fan cooling for normal operation (one-eighth of continuous rated power). The reference design provides all the required housekeeping power supplies for ease of use. The two-channel design is scalable for power and the number of channels.

Applications

- AV receivers
- Home theater systems
- Mini component stereos
- Powered speakers
- Sub-woofers
- Musical instrument amplifiers
- Car audio amplifiers

Features

- Output power:
 - 200 W x 2 channels (10 percent THD+N, $2\ \Omega$ at $\pm 28.5\text{ V}$)
- Multiple protection features:
 - Over-Current Protection (OCP), high-side and low-side
 - Over-Voltage Protection (OVP)
 - Under-Voltage Protection (UVP), high-side and low-side
 - DC Protection(DCP)
 - Over-Temperature Protection (OTP)
- PWM modulator:
 - Self-oscillating half-bridge topology with optional clock synchronization

Table of contents

Table of contents

About this document..... 1

Table of contents..... Error! Bookmark not defined.

1 Specifications 3

2 EVAL_MA5302MS_200WX2 overview 4

3 Set-up guide 5

3.1 Typical connections 5

4 Audio analyzer set-up 6

5 Operating the evaluation board 7

5.1 Test set-up 7

5.2 Power-up sequence..... 7

5.3 Audio functionality tests 7

5.4 External clock function 7

5.5 Power-down sequence 7

6 Audio performance..... 8

6.1 Power vs. THD+N 8

6.2 Frequency response 9

6.3 Noise floor..... 10

6.4 Noise floor with 1 V_{RMS} output 11

7 Efficiency12

8 Thermal information13

8.1.1 Peak power duration thermal information 13

8.1.2 Heatsink installation 17

9 Schematic18

10 PCB.....23

10.1 PCB specification..... 23

10.2 PCB layout 24

11 Bill of Materials (BOM)27

Revision history.....33

Specifications

1 Specifications

Table 1 General test conditions

Condition		Notes/conditions
Supply voltages	$\pm 17\text{ V} \sim \pm 32\text{ V}$	Bipolar power supply
Rated load impedance	2 to 6 Ω	Resistive load
Self-oscillating frequency	400 kHz	No input signal, adjustable
Voltage gain	28 dB	1Vrms input yields rated power

Table 2 Electrical data

Data	Typical	Notes/conditions
Infineon devices	MA5302 integrated class D IC	
Modulator	Self-oscillating, second-order sigma-delta modulation, analog input	
Output power CH1 to 2: (1 percent THD+N)	150 W	1 kHz, $R_L = 2\ \Omega$
Output power CH1 to 2: (10 percent THD+N)	200 W	1 kHz, $R_L = 2\ \Omega$
Rated load impedance	2 to 6 Ω	Resistive load
Idling supply current	+55 mA	No input signal $\pm 28.5\text{ V}$
	-80 mA	
Residual noise	170 μV	Filter: A-weighting(12017), 20 kHz SPCL Gain setting: 28dB
Channel efficiency	94 percent	Single-channel driven, 200 W, class D stage

2 EVAL_MA5302MS_200X2 overview

The EVAL_MA5302MS_200Wx2 features a two-channel self-oscillating type PWM modulator for the lowest component count, highest performance and robust design. This topology represents an analog version of a second-order sigma-delta modulation, having a class D switching stage inside the loop. The benefit of the sigma-delta modulation, in comparison to the carrier-signal based modulation, is that all the error in the audible frequency range is shifted to the inaudible upper-frequency range by nature of its operation. Also, sigma-delta modulation enables the designer to apply sufficient error correction.

The EVAL_MA5302MS_200WX2 self-oscillating topology consists of the following essential functional blocks:

- Front-end integrator
- PWM comparator
- Level shifters
- Integrated gate drivers and MOSFETs
- Output LPF

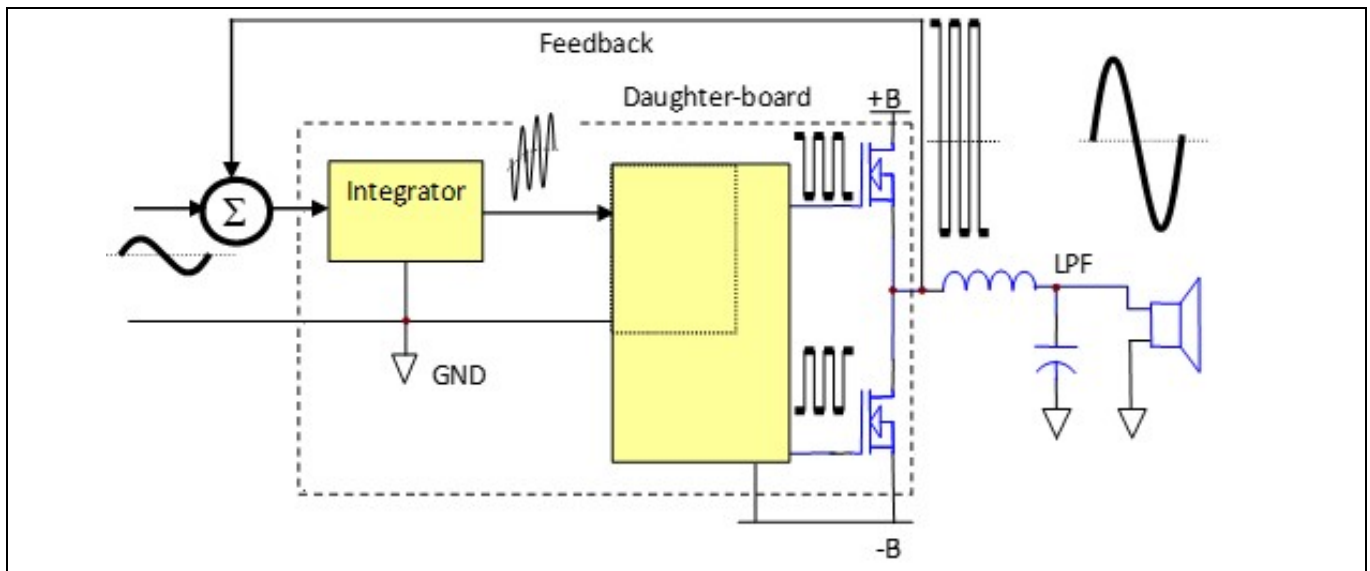

Figure 1 Simplified block diagram of class D amplifier

3 Set-up guide

3.1 Typical connections

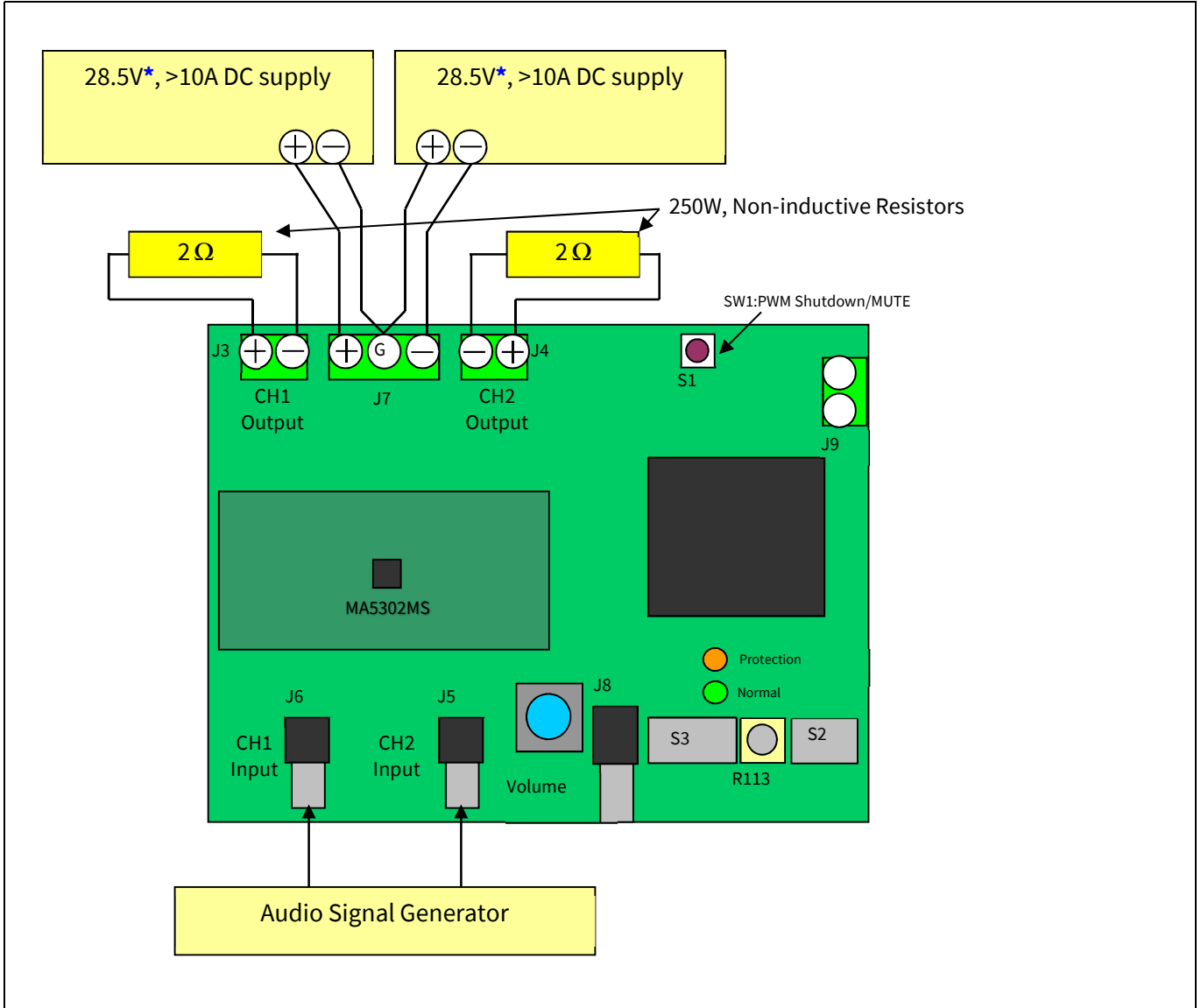

Figure 2 Typical connection connector description

Table 3 Connector description

CH1 IN	J6	Analog input for CH1
CH2 IN	J5	Analog input for CH2
POWER	J7	Positive and negative supply (+B/-B)
CH1 OUT	J3	Output for CH1
CH2 OUT	J4	Output for CH2
EXT CLK	J8	External clock sync

4 Audio analyzer set-up

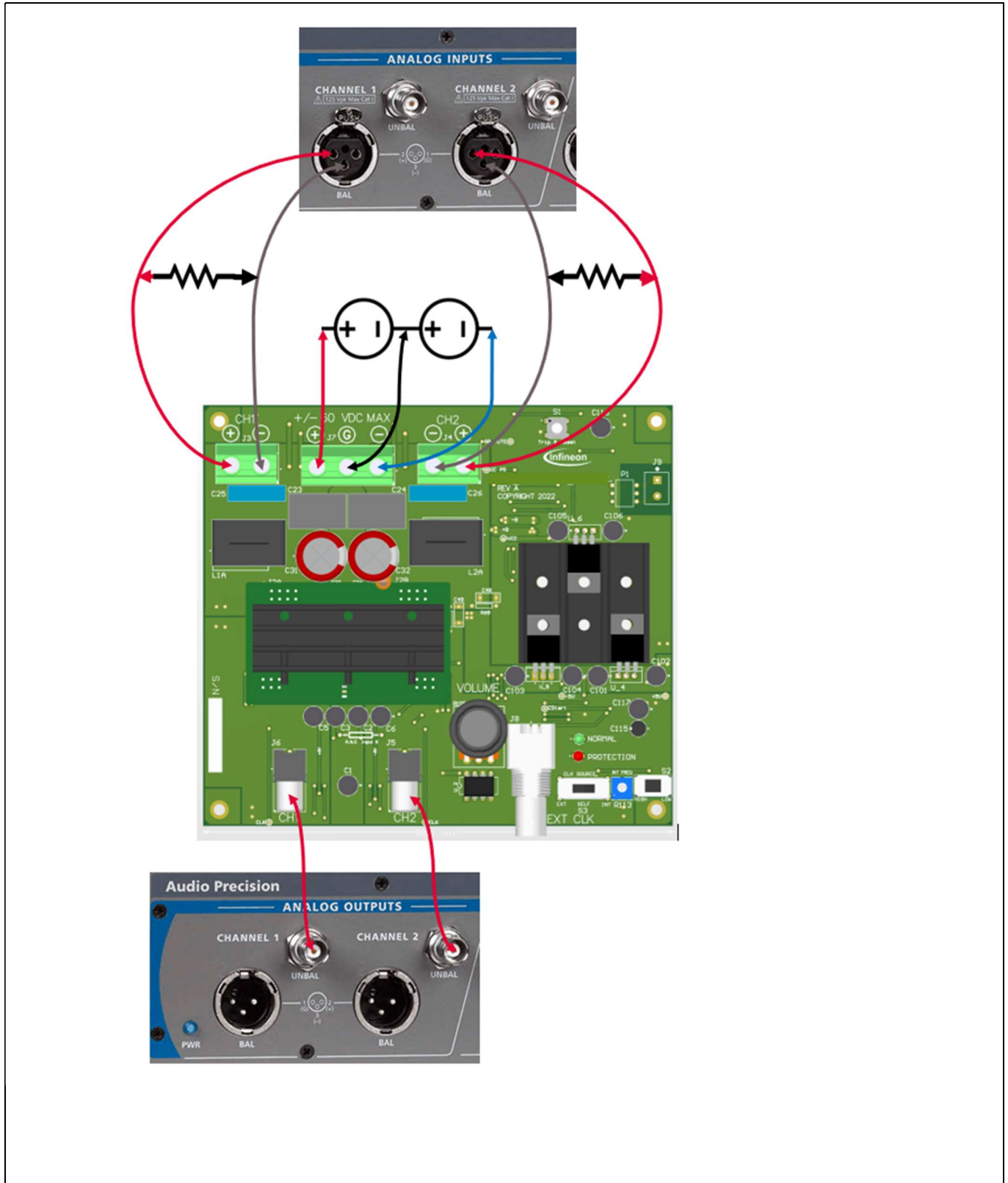

Figure 3 Audio analyzer connection

5 Operating the evaluation board

5.1 Test set-up

1. Connect 2 Ω 250 W dummy loads to output connectors (J3 and J4 as shown in Figure 2) and parallel it with the input of the Audio Precision (AP) analyzer.
2. Connect the Audio Signal Generator (ASG) to J6 and J5 for CH1 and CH2 respectively (AP).
3. Set up the dual power supply with voltages of ± 28.5 V; set current limit to 15 A.
4. Turn off the dual power supply before connecting to “on” of the Unit Under Test (UUT).
5. Set switch S1 to the middle position (self-oscillating).
6. Set volume level knob R108 fully counter-clockwise (minimum volume).
7. Connect the dual power supply to J7, as shown in Figure 2 or Figure 3

5.2 Power-up sequence

8. Turn on the dual power supply. The $\pm B$ supplies must be applied and removed at the same time.
9. Red LED (protection) should turn on almost immediately and turn off after about 3 s.
10. Green LED (normal) then turns on after the red LED is extinguished and should stay on.
11. Quiescent current for the positive supply should be 55 mA \pm 10 mA at ± 28.5 V.
12. Quiescent current for the negative supply should be 80 mA \pm 10 mA at ± 28.5 V.
13. Push S3 switch (trip and reset push-button) to restart the sequence of LED indicators, which should be the same as noted above in steps 9 to 10.

5.3 Audio functionality tests

1. With AP no filter (more than 500 kHz), monitor the channel’s switching frequency on the AP’s analog analyzer.
2. Set S1 to “self” (self-oscillating) position.
3. Set the AP’s analog analyzer to 20 kHz AES17 filter.
4. Connect the audio signal from the AP to J6 and J5.
5. Apply 1 V_{RMS} at 1 kHz sinusoidal signal from the ASG.
6. Turn control volume up (R108 clockwise) to obtain an output reading of 150 W (2 Ω load).
7. Sweep the audio signal voltage from 15 mV_{RMS} to 1.5 V_{RMS}.
8. Run the AP tests as shown in Figures 4 to 11, below.

5.4 External clock function

1. With AP no filter (more than 500 kHz), monitor the channel’s switching frequency on the AP’s analog analyzer.
2. Set S1 to “self” (self-oscillating) position.
3. Set S1 to “Ext” (external clock) position to enable the onboard clock oscillator.
4. Connect the external clock signal generator output to J8.
5. Set the AP’s analog analyzer to 20 kHz AES17 filter
6. Connect the audio signal from the AP to J6 and J5.
7. Sweep the audio signal voltage from 15 mV_{RMS} to 1.5 V_{RMS}.

5.5 Power-down sequence

14. Turn off \pm power supply at the same time.
15. All LEDs turn off when housekeeping power supplies are off.

6 Audio performance

6.1 Power vs. THD+N

Test conditions:

$V_{bus} = \pm 28.5\text{ V}$

Input signal = 1 kHz

Load impedance = $2\ \Omega$

$F_{PWM} = 400\text{ kHz}$

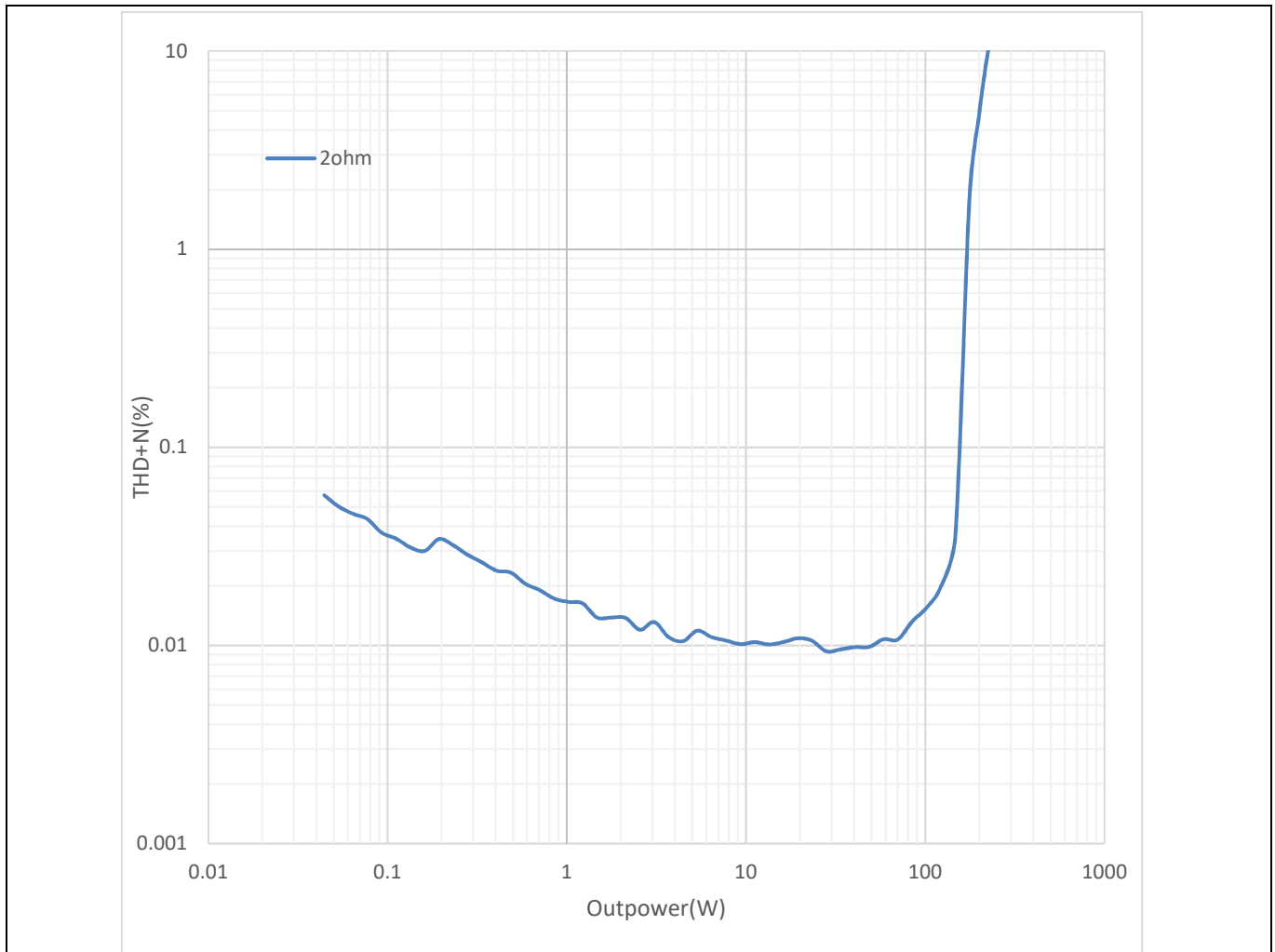

Figure 4 Power vs. THD+N $2\ \Omega$ load

6.2 Frequency response

Test conditions:

$V_{bus} = \pm 28.5\text{ V}$

Output power = 1 W

Load impedance = $2\ \Omega$

$F_{PWM} = 400\text{ kHz}$

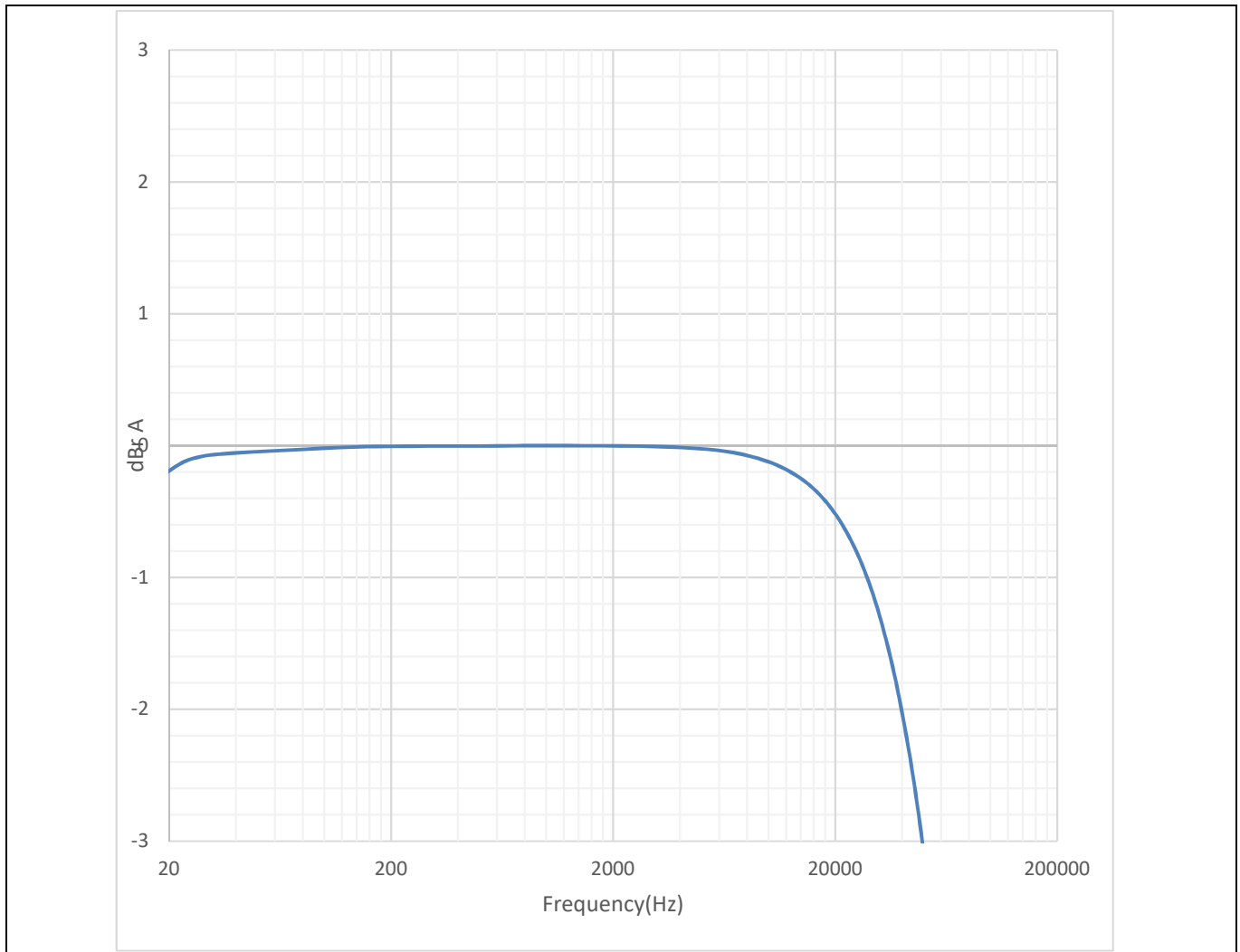

Figure 5 Frequency response $2\ \Omega$ load

6.3 Noise floor

Test conditions:

$V_{bus} = \pm 28.5\text{ V}$

No input signal

Load impedance = $2\ \Omega$

$F_{PWM} = 400\text{ kHz}$

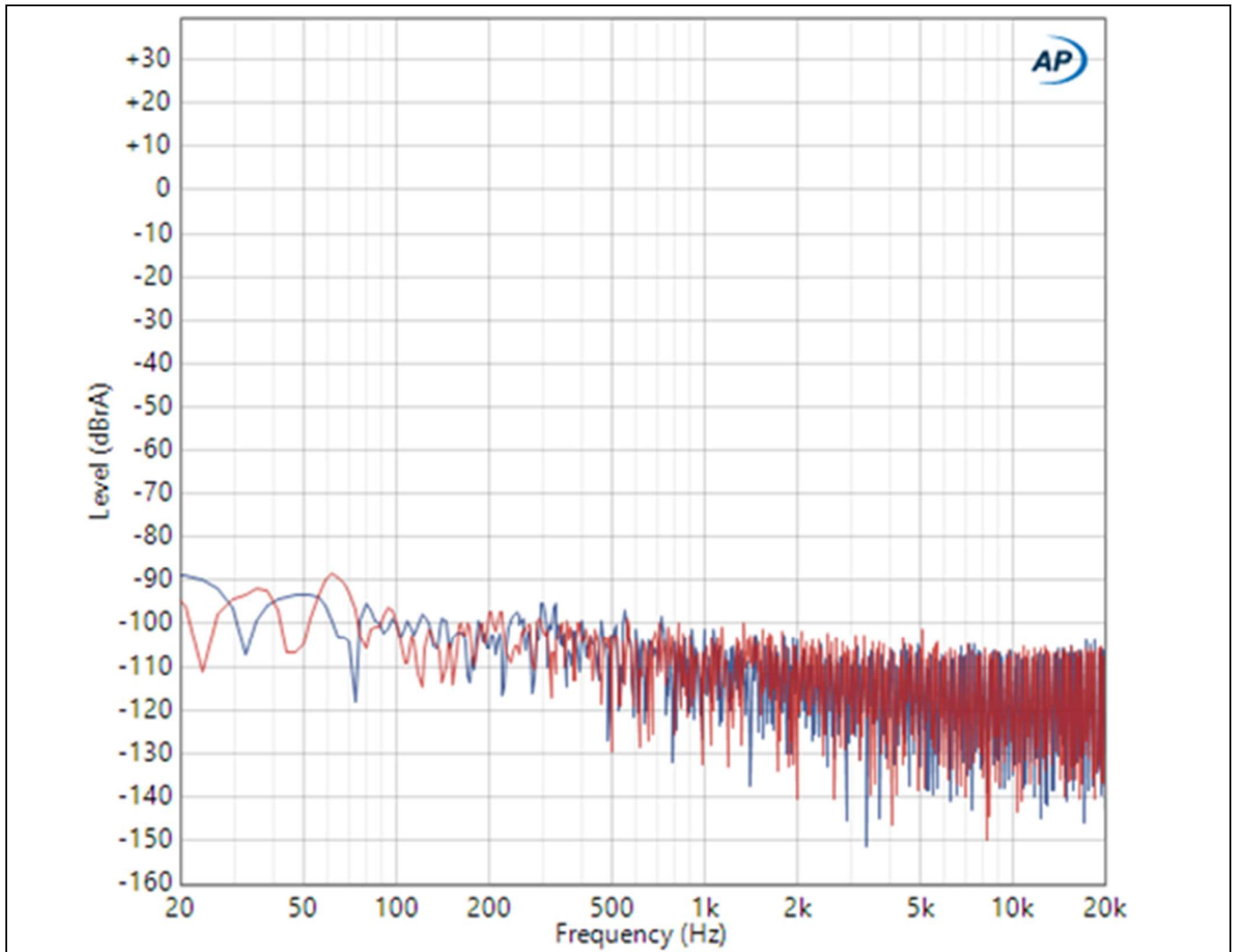

Figure 6 Noise floor $2\ \Omega$ load

6.4 Noise floor with 1 V_{RMS} output

Test conditions:

$V_{bus} = \pm 28.5\text{ V}$

Output = 1 V_{RMS} at 1 kHz

Load impedance = 2 Ω

$F_{PWM} = 400\text{ k}$

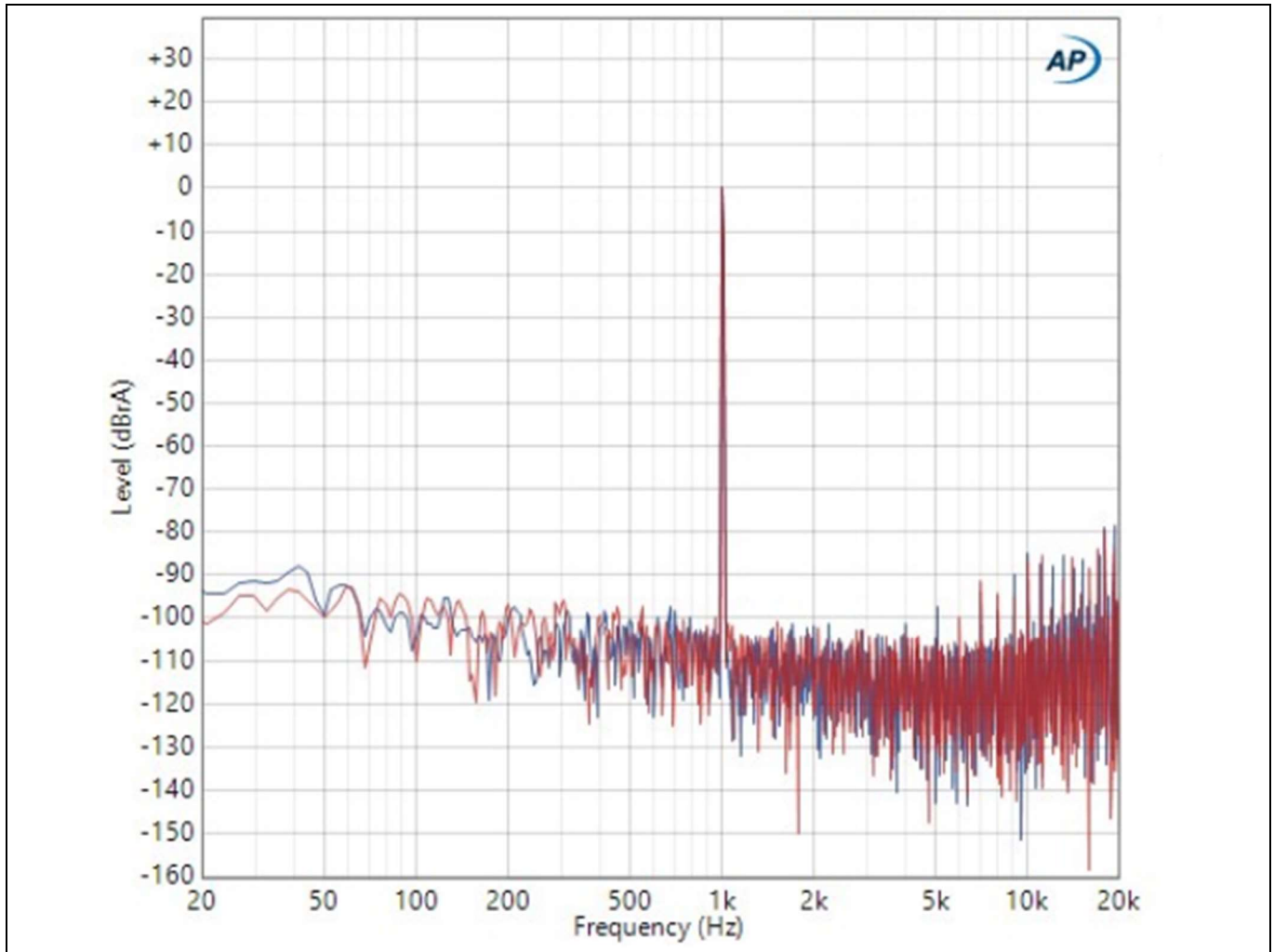

Figure 7 Noise floor with 1 V_{RMS} output 2 Ω load

7 Efficiency

Test conditions:

$V_{bus} = \pm 28.5\text{ V}$

Frequency = 1 kHz

Load impedance = $2\Omega \times 2$

$F_{PWM} = 400\text{ kHz}$

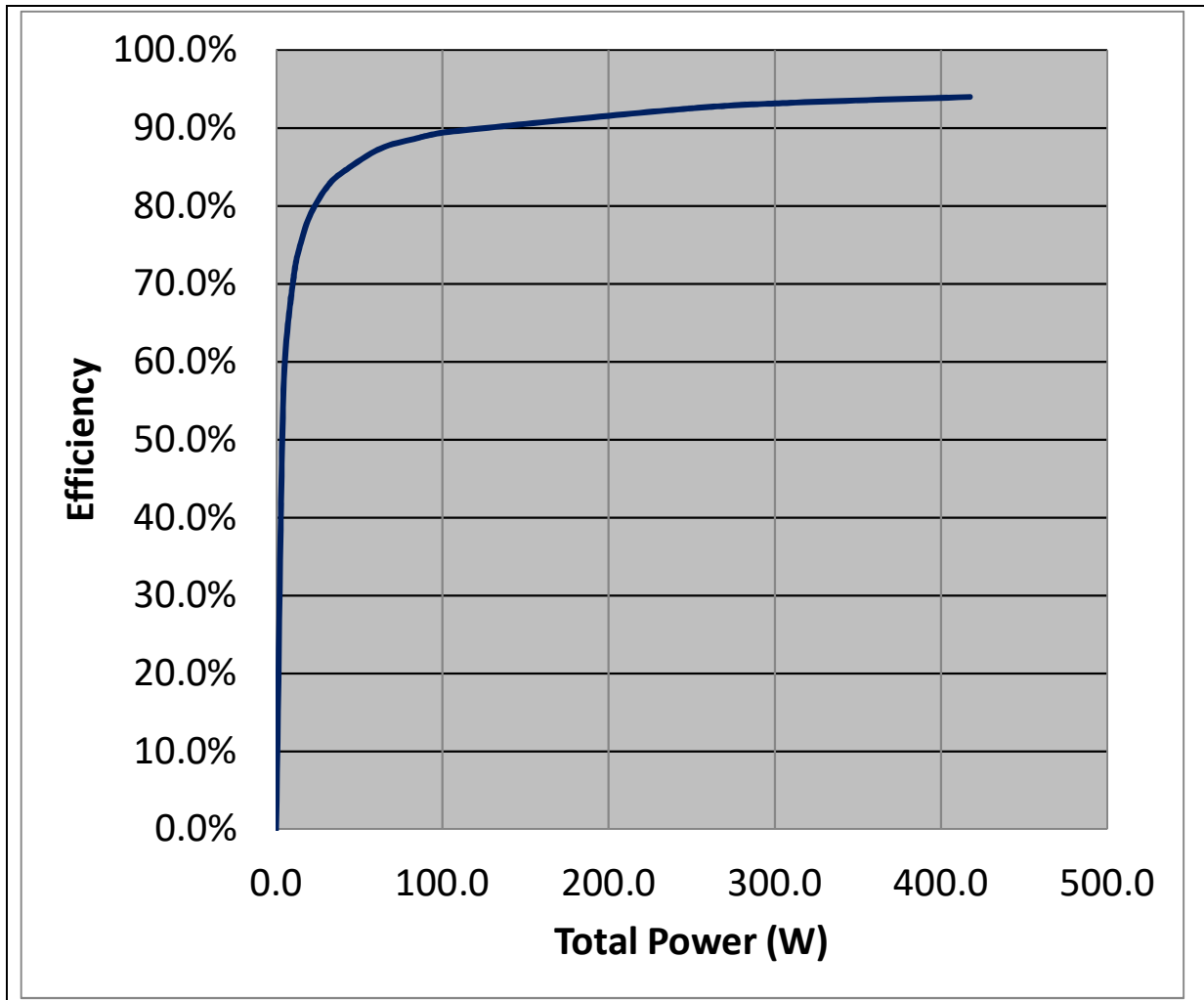

Figure 8 EVAL_MA5302MS_200X2 2 Ω load stereo, $\pm B$ supply = $\pm 28.5\text{ V}$

8 Thermal information

8.1 Peak power duration thermal information

Test conditions:

Input signal = 1 kHz

Both channels driven

$F_{PWM} = 400$ kHz

Table 4 Peak power with heatsink

Load (Ω)	$\pm V_{bus}$ (V)	10 percent THD+N power (W)	Duration
6	32	103	More than 1 minute no thermal shutdown
4	32	151	
3	32	198	
2	28.5	226	

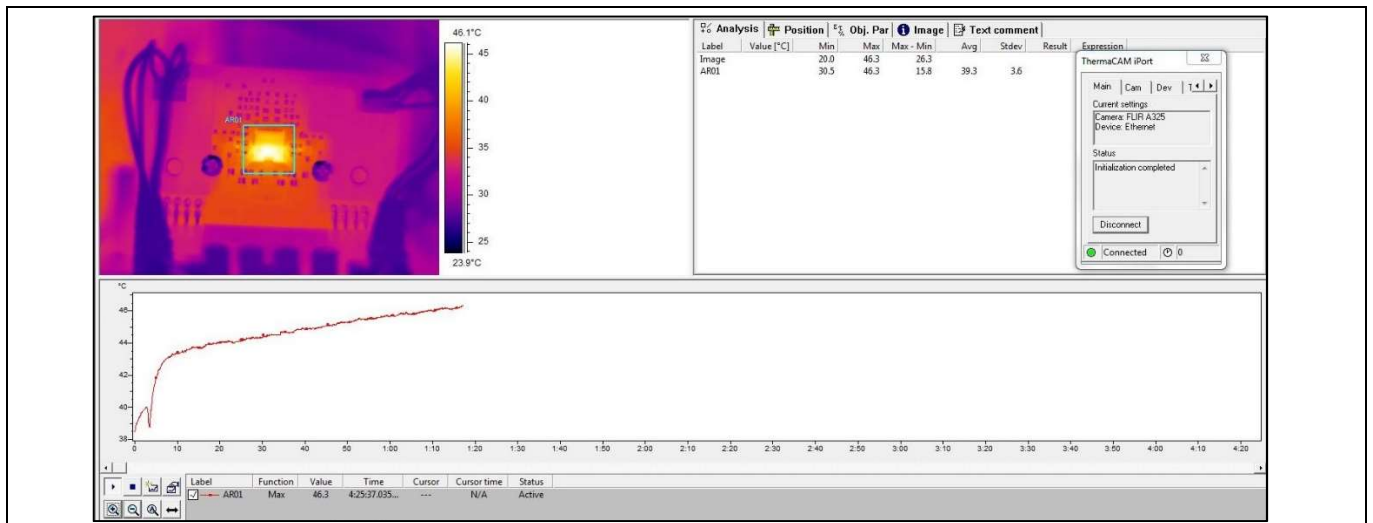

Figure 9 Peak power $P_{out} = 103$ W with 6 Ω load ± 32 V

Note: Maximum temperature 46.3°C at 1 minute.

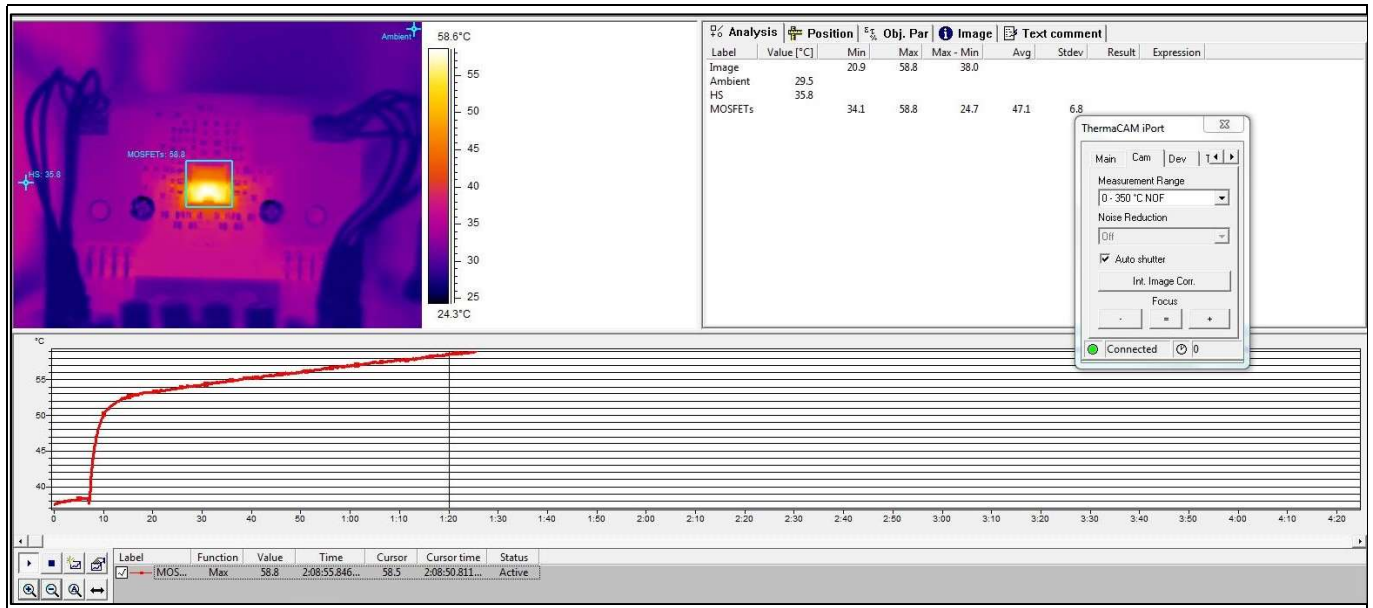

Figure 10 Peak power $P_{out} = 151\text{ W}$ with $4\ \Omega$ load $\pm 32\text{ V}$

Note: Maximum temperature 58.8°C at 1 minute.

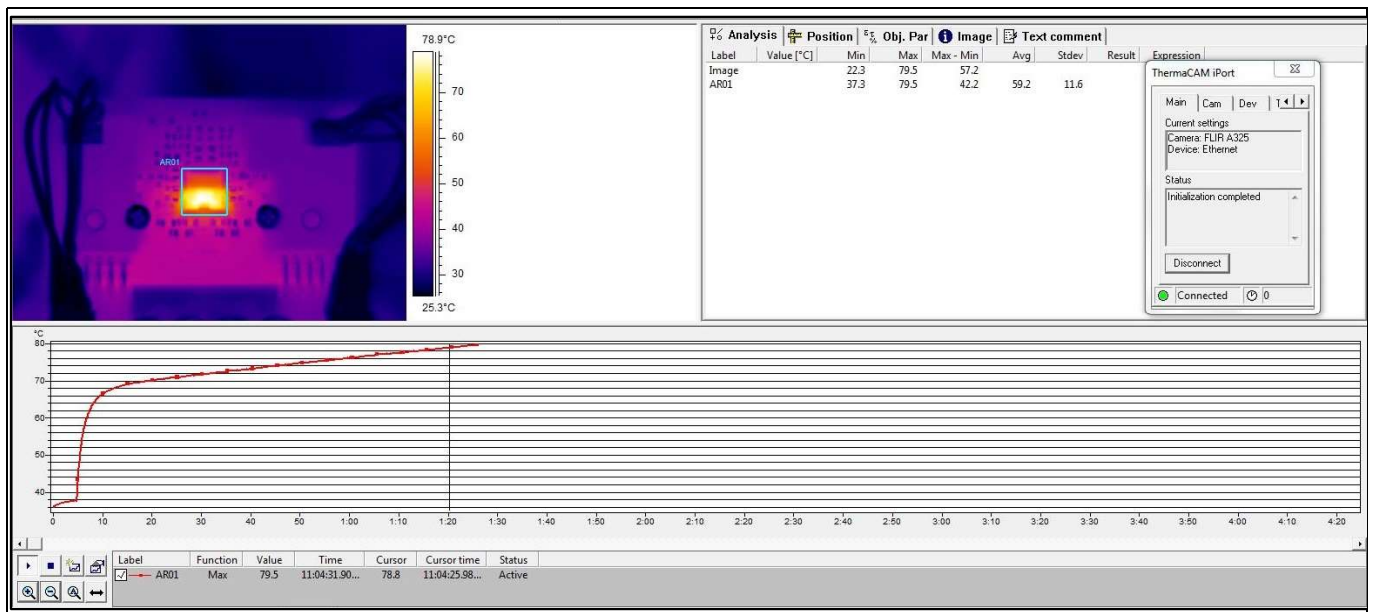

Figure 11 Peak power $P_{out} = 198\text{ W}$ with $3\ \Omega$ load $\pm 32\text{ V}$

Note: Maximum temperature 78.8°C at 1 minute.

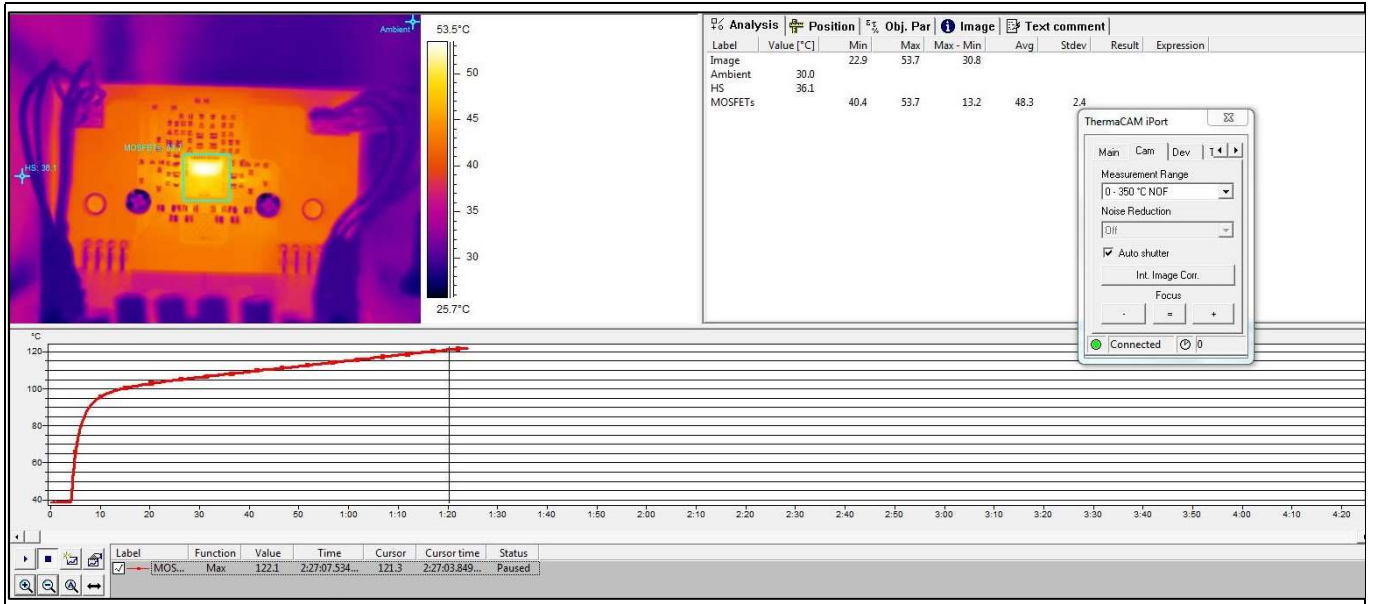

Figure 12 Peak power $P_{out} = 226\text{ W}$ with $2\ \Omega$ load $\pm 28.5\text{ V}$

Note: Maximum temperature 121.3°C at 1 minute.

Table 5 Peak power without heatsink

Load (Ω)	$\pm V_{bus}$ (V)	10 percent THD+N power (W)	Duration
4	30	102	More than 1 minute no thermal shutdown
2	19	100	

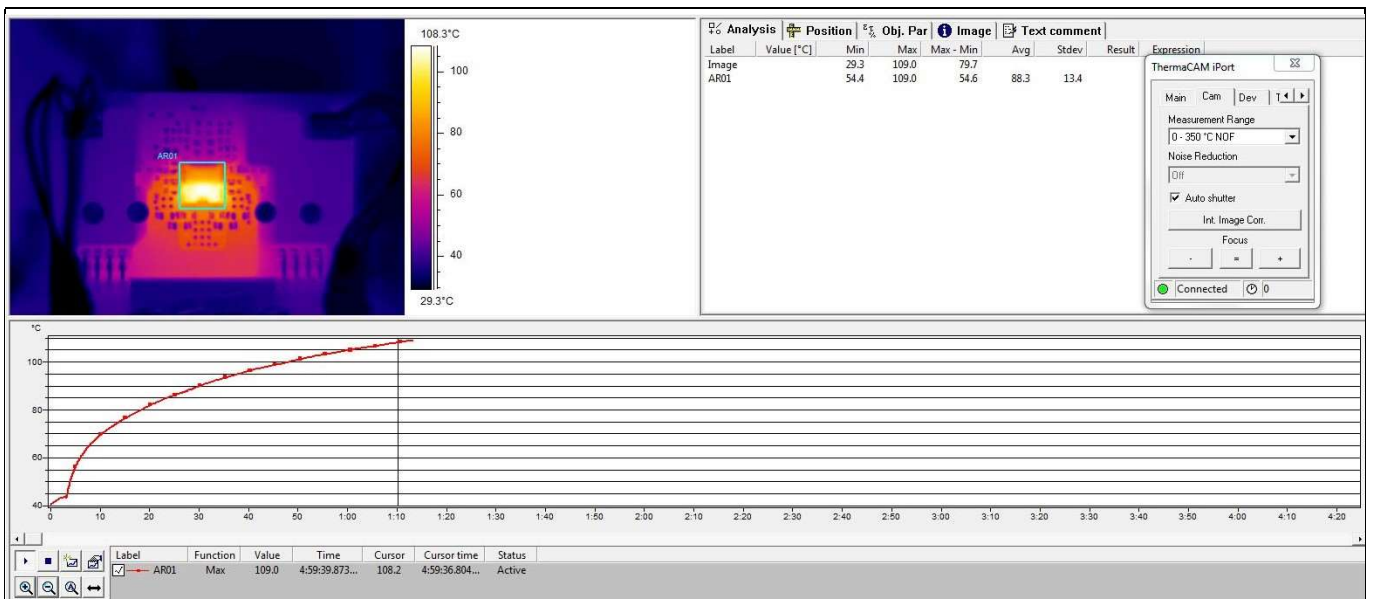

Figure 13 Peak power $P_{out} = 102\text{ W}$ with $4\ \Omega$ load $\pm 30\text{ V}$

Note: Maximum temperature 108.2°C at 1 minute.

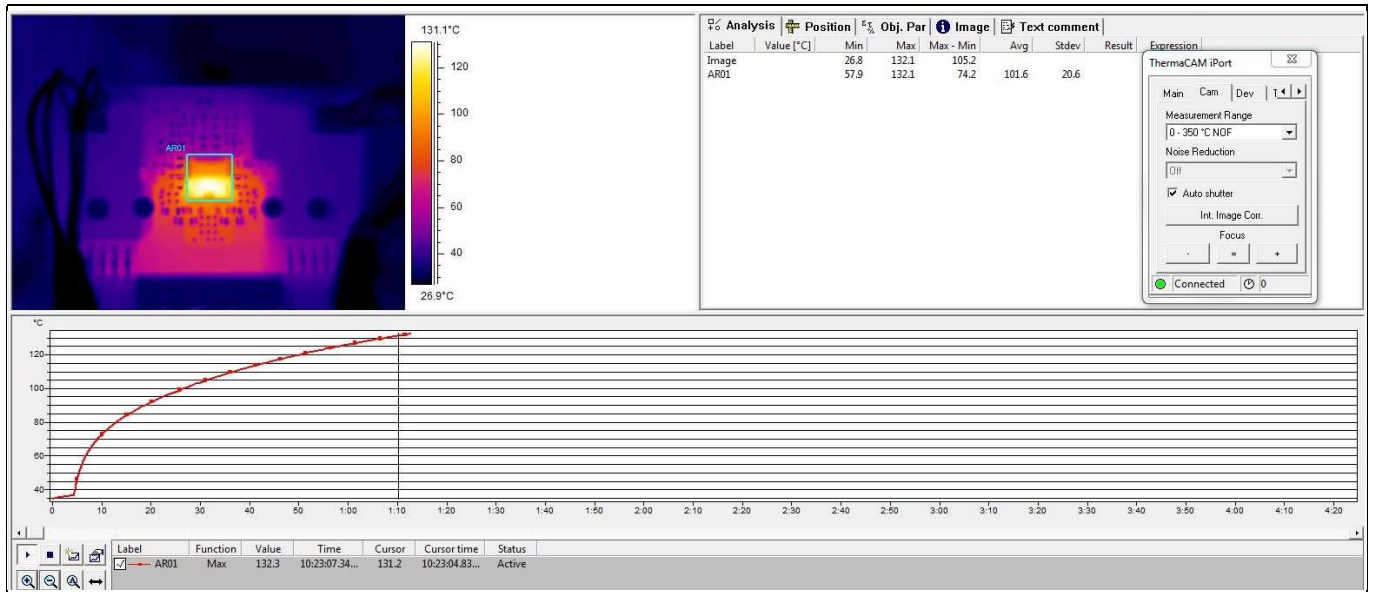

Figure 14 Peak power $P_{out} = 100\text{ W}$ with $2\ \Omega$ load $\pm 19\text{ V}$

Note: Maximum temperature 142.8°C at 1 minute.

Table 6 1/8 power test with heatsink

Load (Ω)	$\pm V_{bus}$ (V)	Max. T-case ($^\circ\text{C}$)	1/8 power (W)	Duration (minutes)
6	32	51.3	10	30
4	32	60.3	14	30
3	32	71.9	19	30
2	28.5	86.7	22	30

Table 7 1/8 power test without heatsink

Load (Ω)	$\pm V_{bus}$ (V)	Max. T-case ($^\circ\text{C}$)	1/8 power (W)	Duration (minutes)
4	30	83.8	13	30
2	28.5	82.1	9	30

8.2 Heatsink installation

Heatsink: V8818V

Thermal pad: BER161-ND



Figure 15 Heatsink installation

9 Schematic

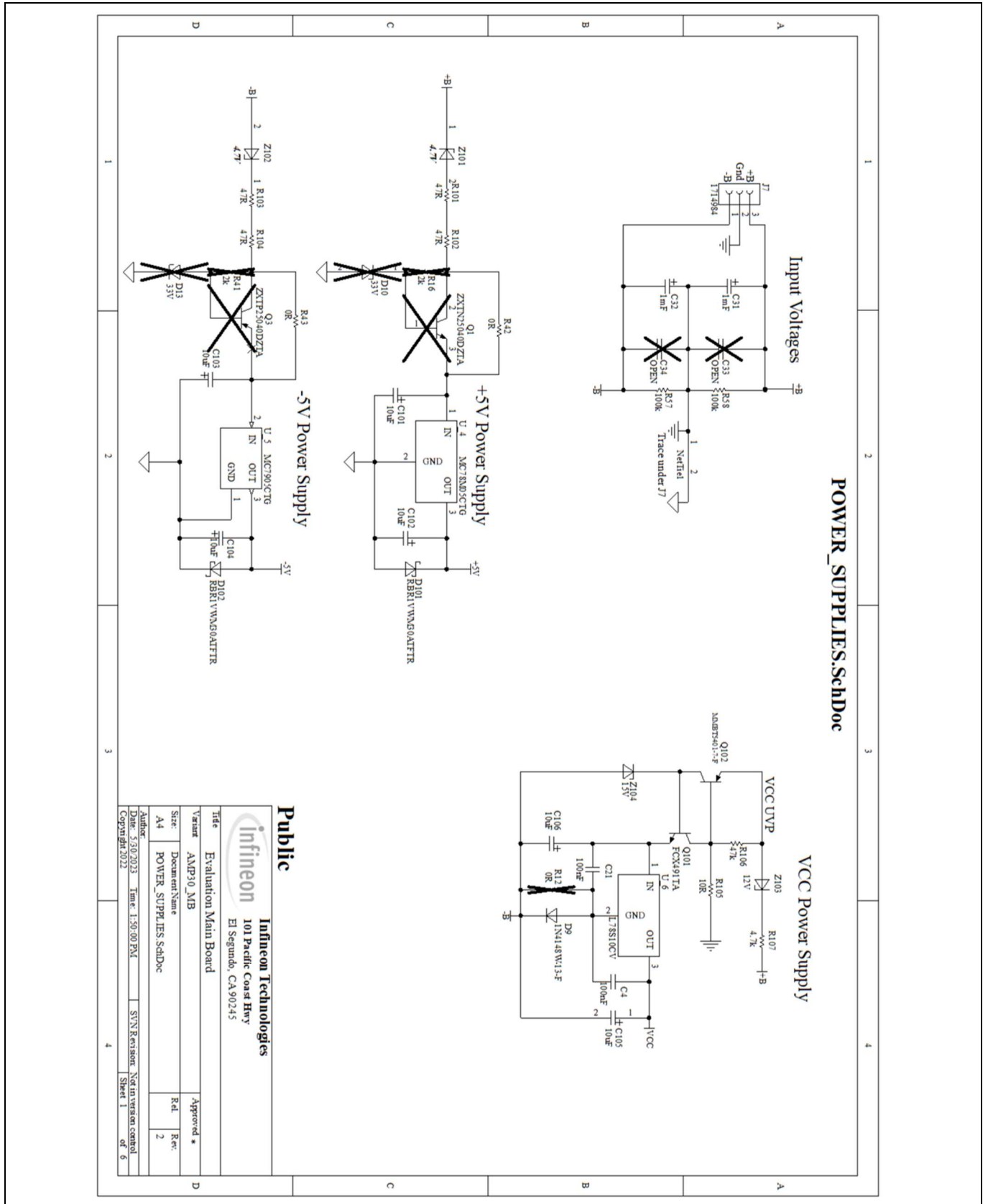

Figure 16 Motherboard schematic 1

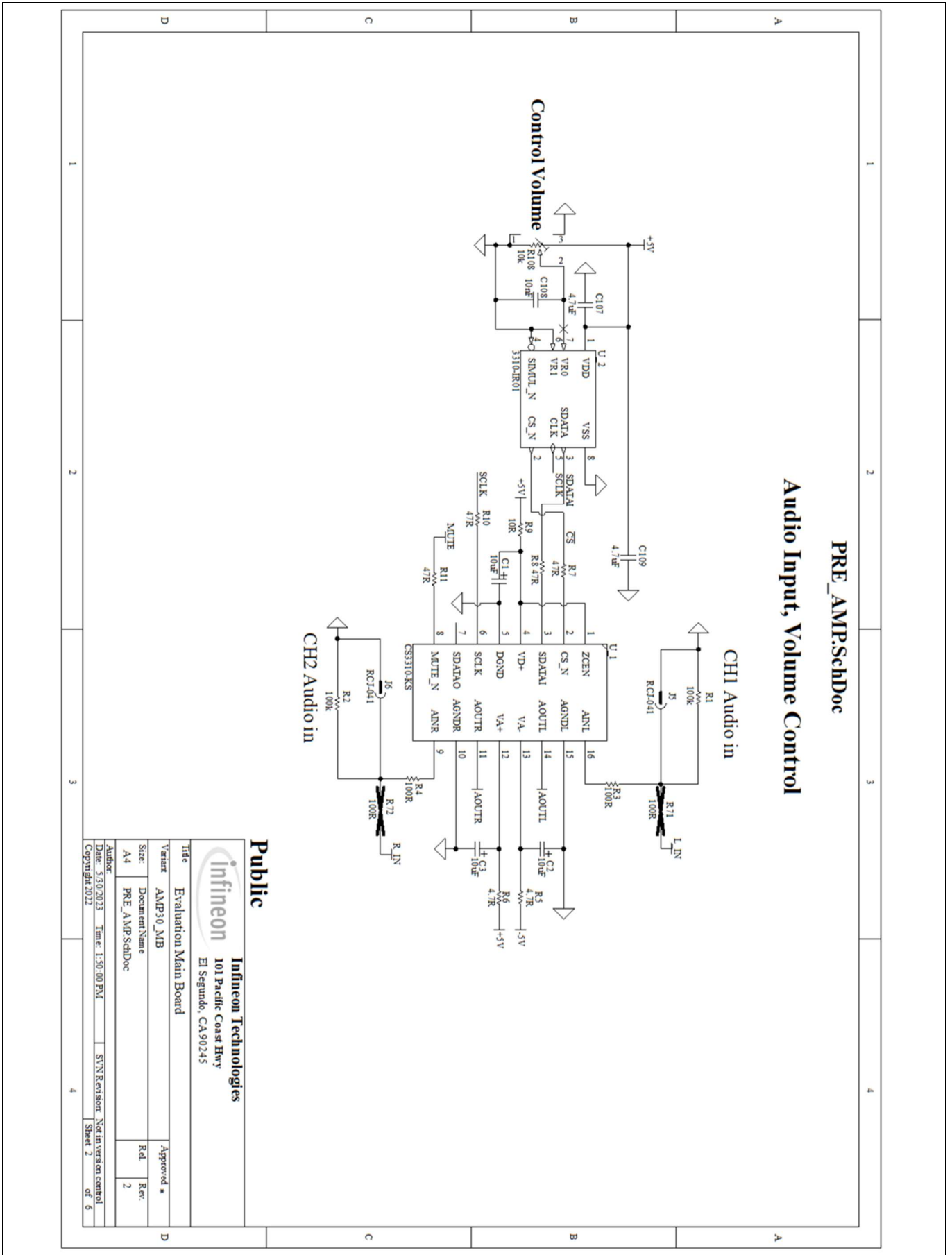

Figure 17 Motherboard schematic 2

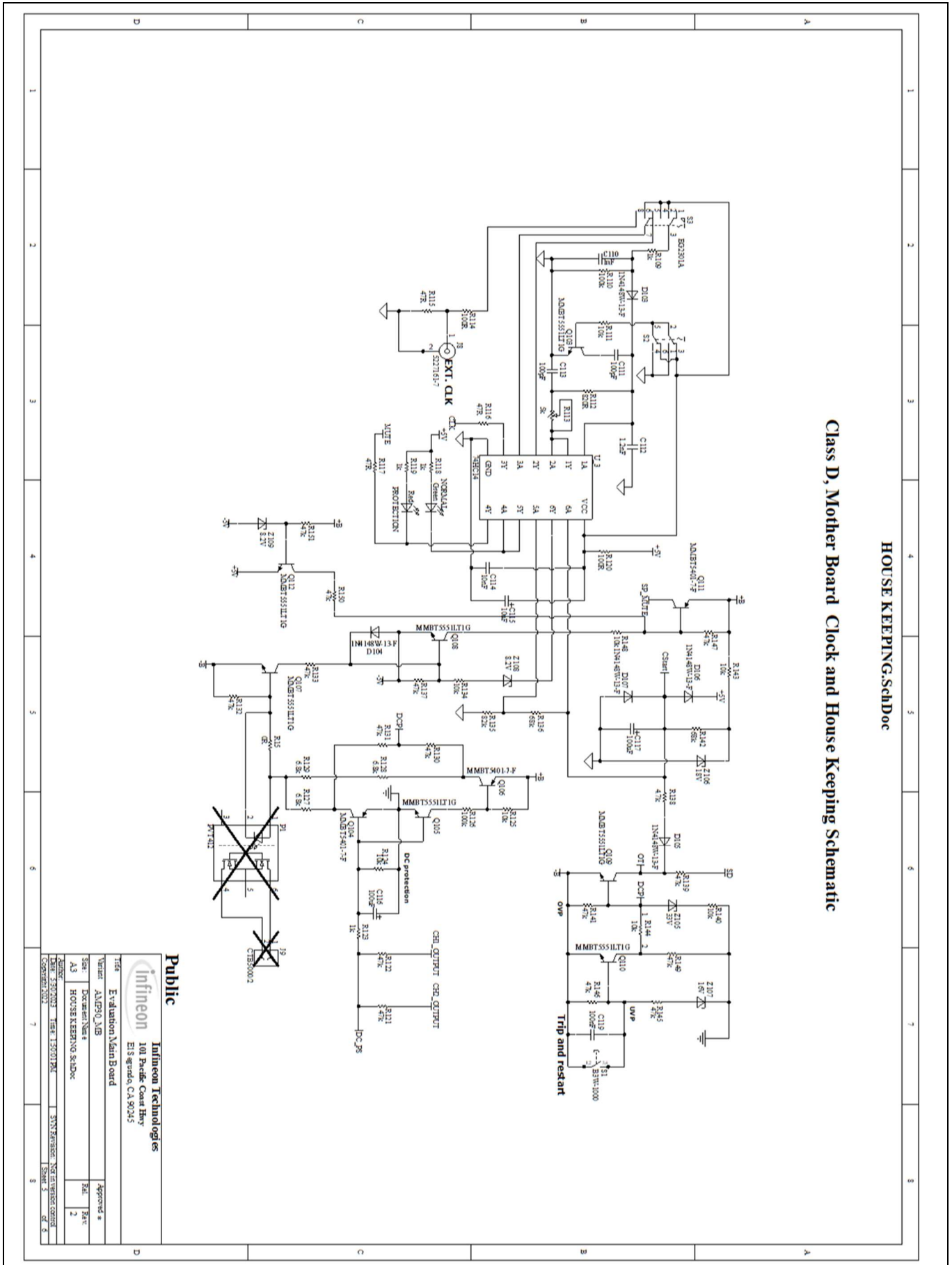

Figure 19 Motherboard schematic 4

10 PCB

10.1 PCB specification

1. Two-layer SMT PCB with through-holes
2. 1/16 thickness
3. 2/0 oz. Cu
4. FR4 material
5. 20 mil lines and spaces
6. Solder mask to be green enamel EMP110 DBG (CARAPACE) or Enthone endplate DSR-3241 or equivalent
7. Silkscreen to be white epoxy non-conductive per IPC-RB 276 standard
8. All exposed copper must be finished with tin-lead Sn 60 or 63 for 100 μ inches thick
9. Tolerance of PCB size shall be 0.010 to 0.000 inches
10. Tolerance of all holes is/- 0.003 inches
11. PCB acceptance criteria as defined for class II PCB standards

10.2 PCB layout

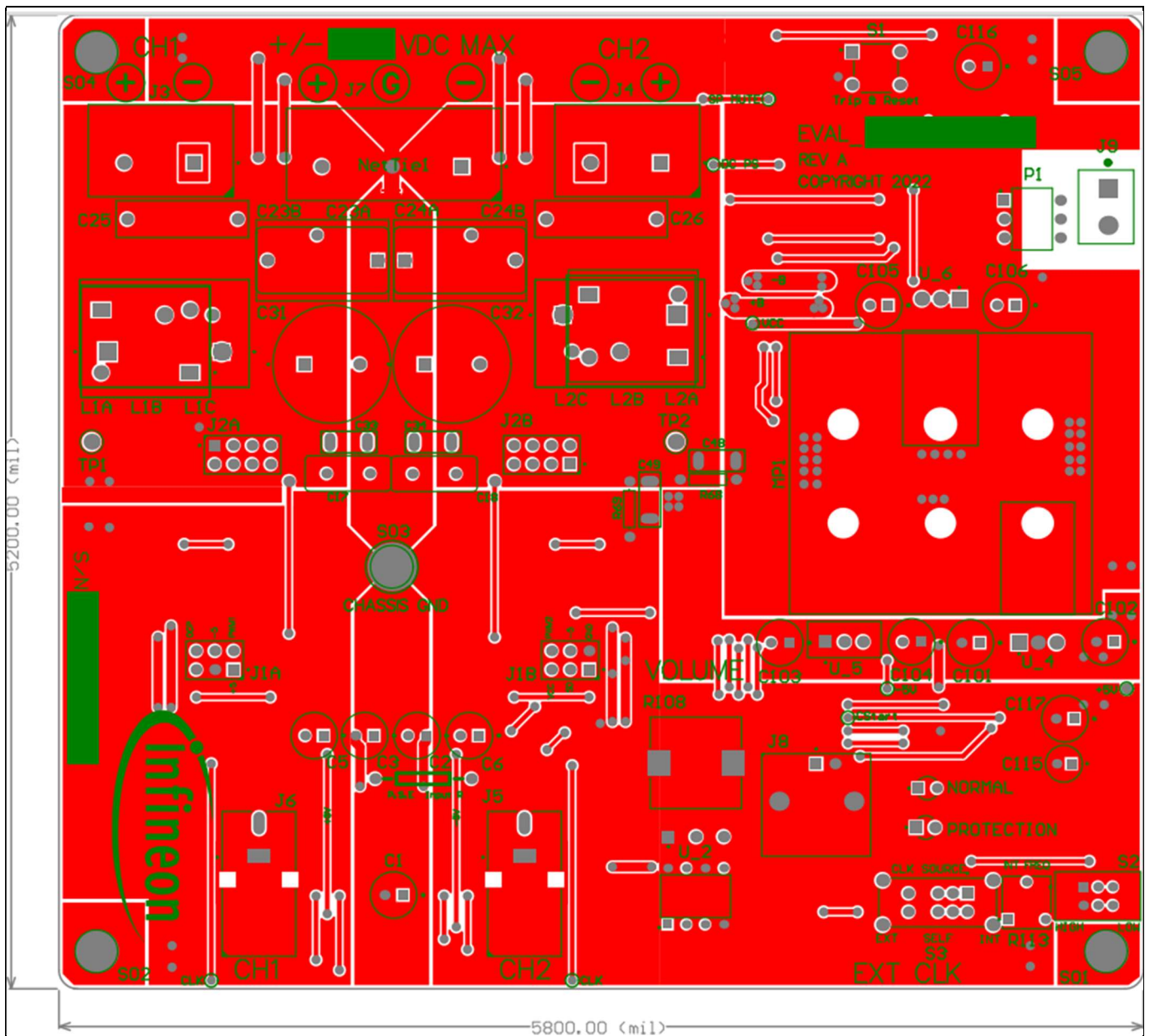

Figure 21 Motherboard top view

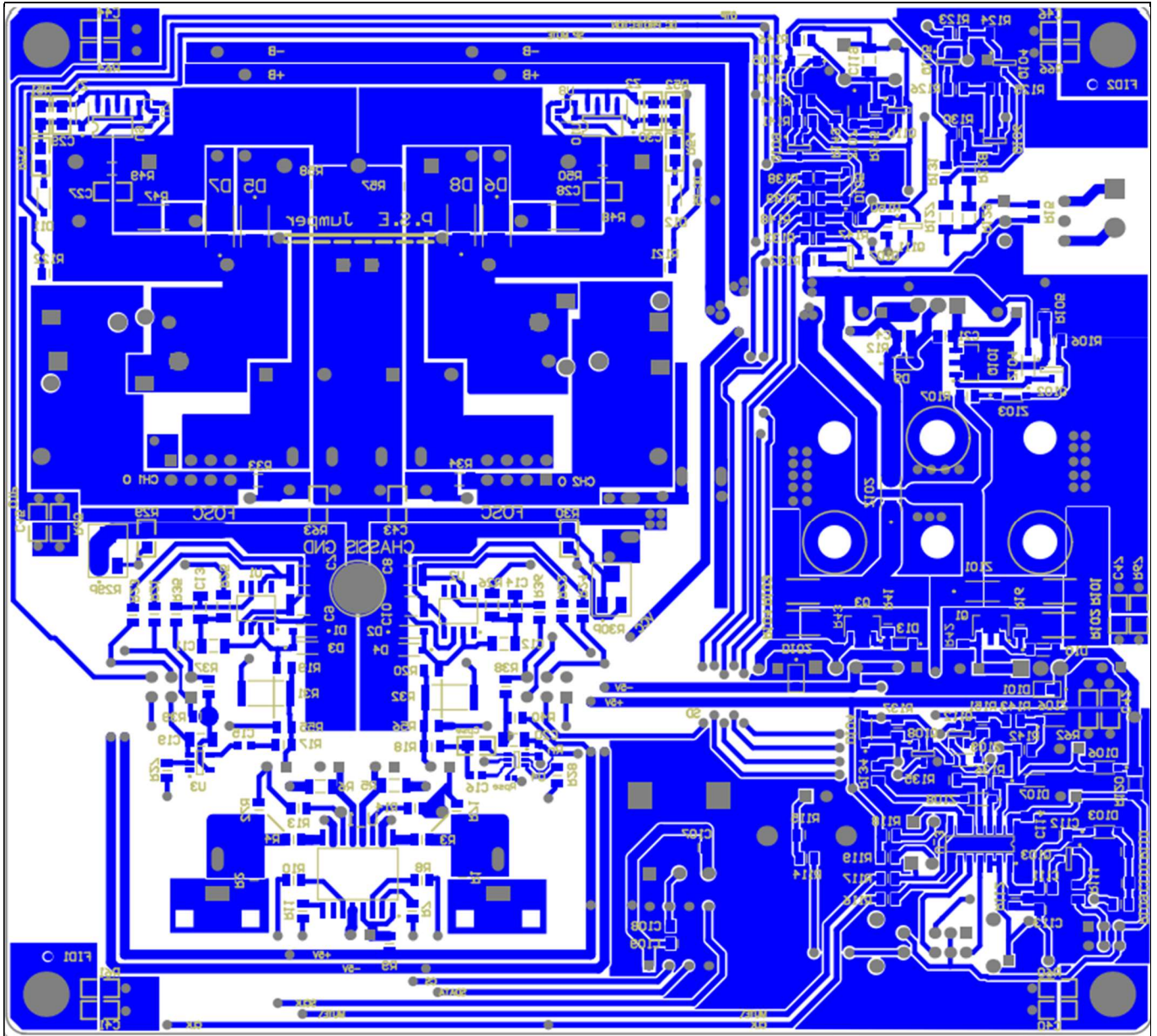

Figure 22 Motherboard bottom view

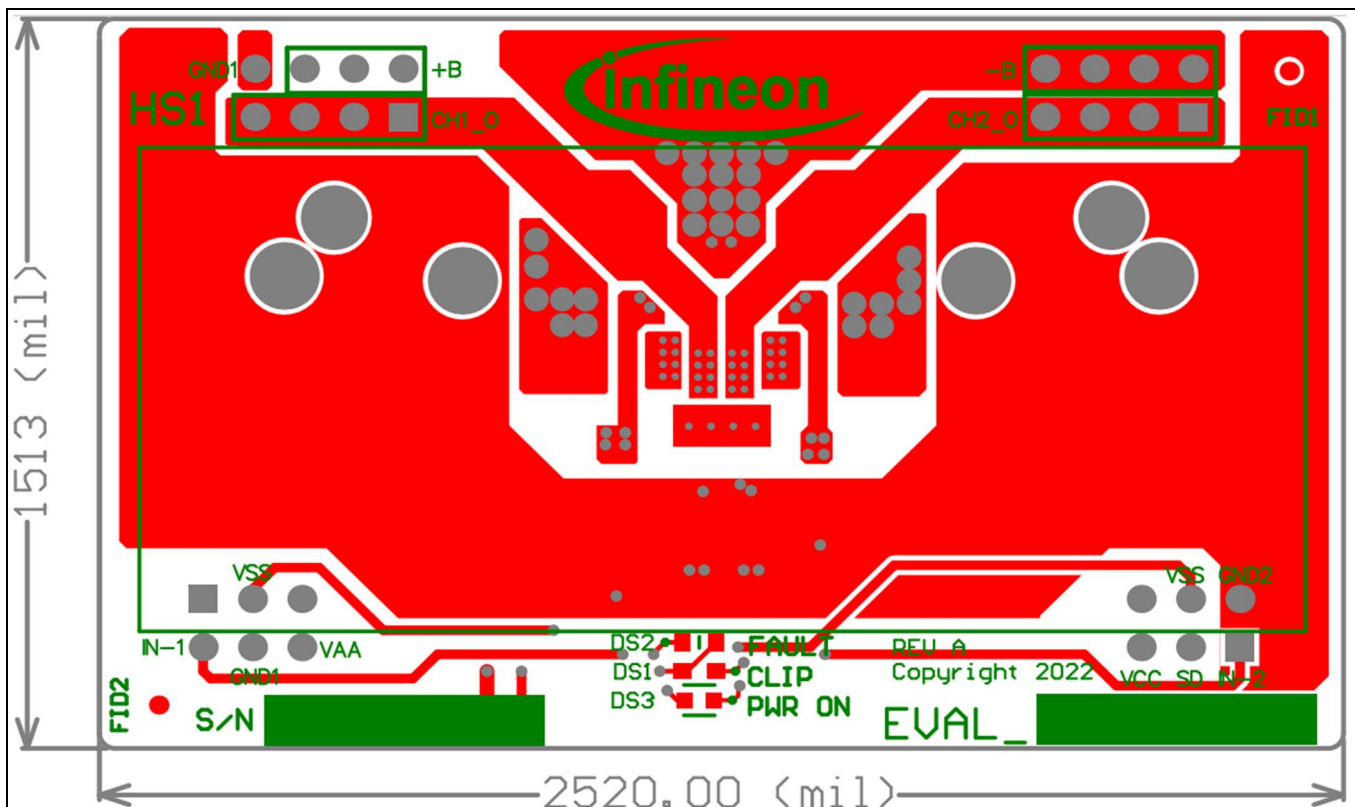

Figure 23 Daughterboard top view

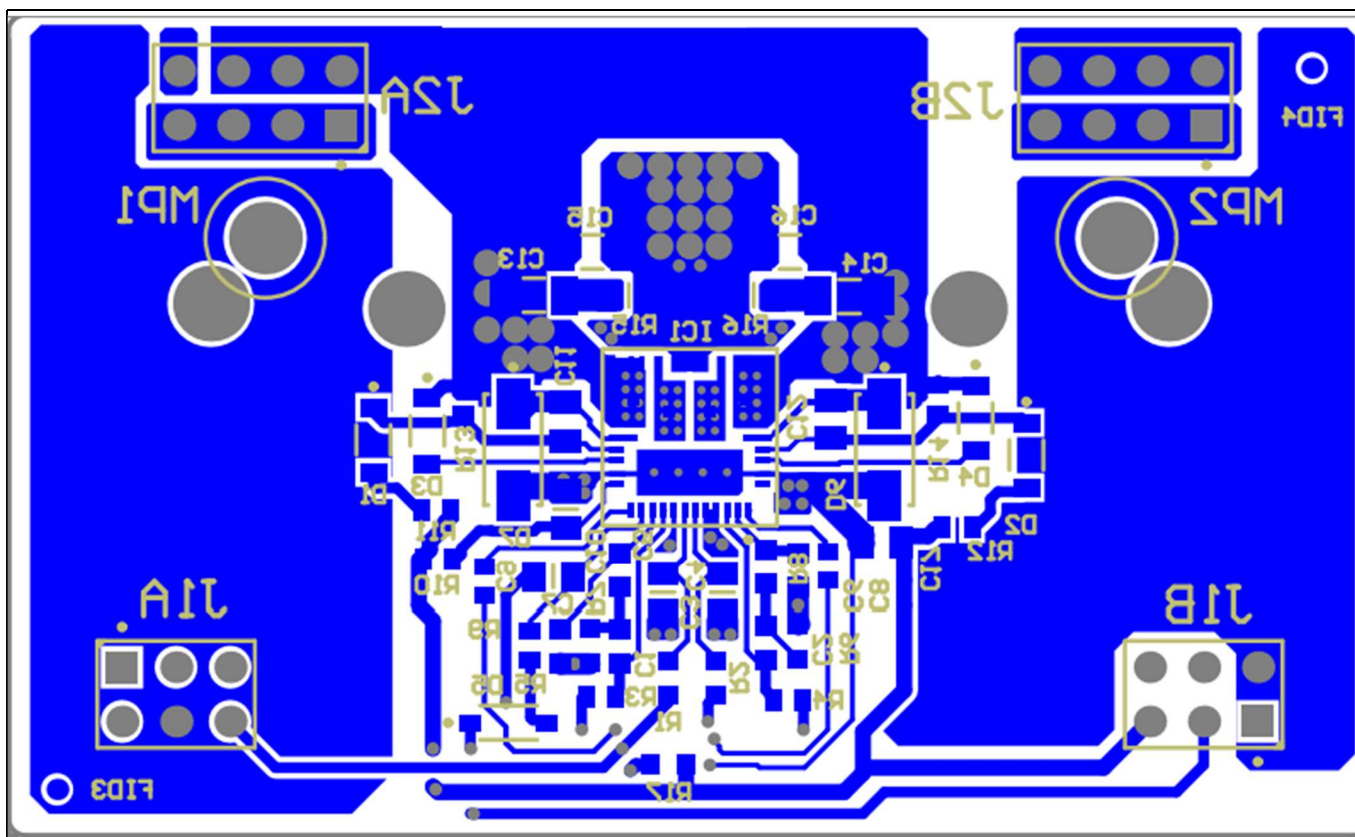

Figure 24 Daughterboard bottom view

11 Bill of Materials (BOM)

Table 8 Motherboard BOM

No.	Part number	Designator	Description	Quantity	Vendor
1	565-1106-ND	C1, C5, C6, C101, C102, C103, C104, C105, C106, C115	CAP ALUM 10UF 20% 50V RADIAL	10	Digikey
2	565-1103-ND	C2, C3	CAP ALUM 2.2UF 20% 50V RADIAL	2	Digikey
	478-10836-6-ND	C4, C21	CAP CER 0.1UF 50V X7R 0805	2	Digikey
3	478-1281-1-ND	C15, C16	CAP CER 33PF 100V COG/NP0 0805	2	Digikey
4	338-2598-ND	C17, C18	CAP MICA 150PF 5% 500V RADIAL	2	Digikey
5	1276-3141-1-ND	C19, C20	CAP CER 2.2UF 16V X7R 1206	2	Digikey
6	732-8127-1-ND	C119	CAP CER 0.1UF 50V X7R 1206	1	Digikey
7	495-B32652A3105K000-ND	C23A, C24A	CAP FILM 1UF 10% 250VDC RADIAL	2	Digikey
8	495-1311-ND	C25, C26	CAP FILM 0.1UF 5% 400VDC RADIAL	2	Digikey
9	565-1114-ND	C31, C32	CAP ALUM 1000UF 20% 50V RADIAL	2	Digikey
10	490-14466-1-ND	C107, C109	CAP CER 4.7UF 16V X7R 0805	2	Digikey
11	732-8074-1-ND	C108, C114	CAP CER 10000PF 50V X7R 0805	2	Digikey
12	732-7858-1-ND	C110	CAP CER 1000PF 50V COG/NP0 0805	1	Digikey
13	732-7852-1-ND	C111, C113	CAP CER 100PF 50V COG/NP0 0805	2	Digikey
14	478-1372-1-ND	C112	CAP CER 1200PF 50V X7R 0805	1	Digikey
15	565-1037-ND	C116, C117	CAP ALUM 100UF 20% 16V RADIAL	2	Digikey
16	1N4148W-FDICT-ND	D9, D103, D104, D105, D106, D107	DIODE GEN PURP 100V 300MA SOD123	5	Digikey
17	ES2DFSCCT-ND	D5, D6, D7, D8	DIODE GEN PURP 200V 2A D0214AA	4	Digikey
18	846-RBR1VWM30ATFTRCT-ND	D101, D102	DIODE SCHOTTKY 30V 1A PMDE	2	Digikey

No.	Part number	Designator	Description	Quantity	Vendor
19	294-1086-ND	HS1	HEATSINK HORZ SIX BLACK TO-220	1	Digikey
20	A32934-ND	J1A, J1B	CONN RCPT 6POS 0.1 GOLD PCB	2	Digikey
18	478-1281-1-ND	C40, C58	Ceramic capacitor 33 pF 5 percent 100 V NP0 0805	2	Digikey
19	445-1432-1-ND	C41, C43, C59, C61	Ceramic capacitor 3.3 μ F 50 V X7R 20 percent 1210	4	Digikey
20	565-1161-ND	C45, C46, C47, C48	Capacitor 1200 μ F 100 V elect. SMG RAD	4	Digikey
21	PCC1812CT-ND	C62, C63, C68, C78	Capacitor .1 μ F 16 V ceramic X7R 0805	4	Digikey
21	A32935-ND	J2A, J2B	CONN RCPT 8POS 0.1 GOLD PCB	2	Digikey
22	277-1271-ND	J3, J4	TERM BLK 2P SIDE ENT 9.53MM PCB	2	Digikey or Mouser
23	CP-1422-ND	J5, J6	CONN RCA JACK MONO 3.2MM R/A	2	Digikey
24	277-1272-ND	J7	TERM BLK 3P SIDE ENT 9.53MM PCB	1	Digikey or Mouser
25	A32248-ND	J8	CONN BNC JACK R/A 50 OHM PCB	1	Digikey
26					
27	7G23C-100M	L1A, L2A	Class D inductor, 10UH	2	Sagami
	CPD2315-100M				DIGIKEY
	CPD1715F-100M				CODACA
28	160-1143-ND	NORMAL	LED GREEN CLEAR T-1 T/H	1	Digikey
29					
30	160-1140-ND	PROTECTION	LED RED CLEAR T-1 T/H	1	Digikey
31	FCX491CT-ND	Q101	TRANS NPN 60V 1A SOT-89	1	Digikey
32	MMBT5401-FDICT-ND	Q102, Q104, Q106, Q111	TRANS PNP 150V 0.6A SMD SOT23-3	4	Digikey
33	MMBT5551-FDICT-ND	Q103, Q105, Q107, Q108, Q109, Q110, Q112	TRANS NPN 160V 0.6A SOT23-3	7	Digikey
34	P100KACT-ND	R1, R2, R57, R58, R110, R126	RES SMD 100K OHM 5% 1/8W 0805	6	Digikey
35	P100ACT-ND	R3, R4, R114	RES SMD 100 OHM 5% 1/8W 0805	3	Digikey

No.	Part number	Designator	Description	Quantity	Vendor
36	P4.7ECT-ND	R5, R6	RES SMD 4.7 OHM 5% 1/4W 1206	2	Digikey
37	P47ACT-ND	R7, R8, R10, R11, R27, R28, R115, R116, R117	RES SMD 47 OHM 5% 1/8W 0805	9	Digikey
38	P10ACT-ND	R9, R105	RES SMD 10 OHM 5% 1/8W 0805	2	Digikey
39	P2.7KDACT-ND	R13, R14	RES 2.7K OHM 0.1% 1/8W 0805	2	Digikey
40	P22KACT-ND	R17, R18	RES SMD 22K OHM 5% 1/8W 0805	2	Digikey
41	P47KACT-ND	R106, R121, R122, R130, R131, R132, R133, R137, R139, R141, R145, R146, R147, R149, R150, R151	RES SMD 47K OHM 5% 1/8W 0805	16	Digikey
42	P0.0ACT-ND	R55, R56, R15, R42, R43	RES SMD 0 OHM JUMPER 1/8W 0805	5	Digikey
43	P470ACT-ND	R39, R40	RES SMD 470 OHM 5% 1/8W 0805	2	Digikey
44	P100ECT-ND	R120	RES SMD 100 OHM 5% 1/4W 1206	1	Digikey
45	TNPW251247K0BEEG- ND	R31, R32	RES 47K OHM 0.1% 1/2W 2512	2	Digikey
	CPD3119-220M	Substitute			CODACA
46	YAG2331CT-ND	R33, R34	RES SMD 1K OHM 0.1% 1/4W 1206	2	Digikey
47	P1.0KACT-ND	R109, R118, R119, R123	RES SMD 1K OHM 5% 1/8W 0805	4	Digikey
48	PT10XCT	R47, R48	RES SMD 10 OHM 5% 1W 2512	2	Digikey
49	P2.2KECT-ND	R49, R50	RES SMD 2.2K OHM 5% 1/4W 1206	2	Digikey
50	PT47XCT-ND	R101, R102, R103, R104	RES SMD 47 OHM 5% 1W 2512	4	Digikey
51	P4.7KACT-ND	R107, R138	RES SMD 4.7K OHM 5% 1/8W 0805	2	Digikey
52	PDB12-H4251-103BF	R108	POT 10K OHM 0.08W CARBON LINEAR	1	Digikey
53	P10KACT-ND	R111, R124, R125, R134, R140, R143, R144, R148	RES SMD 10K OHM 5% 1/8W 0805	8	Digikey
54	P820ACT-ND	R112	RES SMD 820 OHM 5% 1/8W 0805	1	Digikey

No.	Part number	Designator	Description	Quantity	Vendor
55	3362H-502LF-ND	R113	TRIMMER 5K OHM 0.5W PC PIN TOP	1	Digikey
56	P6.8KECT-ND	R127, R128, R129	RES SMD 6.8K OHM 5% 1/4W 1206	3	Digikey
57	P82KACT-ND	R135	RES SMD 82K OHM 5% 1/8W 0805	1	Digikey
58	P68KACT-ND	R136, R142	RES SMD 68K OHM 5% 1/8W 0805	2	Digikey
59	RMCF0402ZT0R00CT- ND	Rn	RES 0 OHM JUMPER 1/16W 0402	1	Digikey
60	P8010S-ND	S1	SWITCH TACTILE SPST- NO 0.02A 15V	1	Digikey
61	EG1908-ND	S2	SWITCH SLIDE DPDT 100MA 12V	1	Digikey
62	EG1944-ND	S3	SWITCH SLIDE DP3T 200MA 30V	1	Digikey
63	296-11599-1-ND	U3	SN74LVC1G04DBVR	1	Digikey
64	296-13261-1-ND	U4	SN74LVC2G04DBVR	1	Digikey
65	73C8016 or 72J5420	U_1	IC, DIGITAL VOLUME CONTROL, SOIC-16	1	Newark
66	3310-IR01	U_2	CS3310 Stand-alone Controller	1	*Tachyonix
67	296-1194-1-ND	U_3	IC INVERTER SCHMITT 6CH 14SOIC	1	Digikey
68	MC78M05CTGOS-ND	U_4	IC REG LINEAR 5V 500MA TO220AB	1	Digikey
69	LM79M05CT-ND	U_5	IC REG LINEAR -5V 500MA TO220-3	1	Digikey
70	497-6039-5-ND	U_6	IC REG LINEAR 10V 2A TO220AB	1	Digikey
71	BZT52C15-FDICT-ND	Z103	DIODE ZENER 15V 500MW SOD123	1	Digikey
72	1SMA5917BT3GOSCT- ND	Z101, Z102	DIODE ZENER 4.7V 1.5W SMA	2	Digikey
73	863-MMSZ5245BT1G	Z104	DIODE ZENER 15V 500MW SOD123	1	Digikey
74	1727-7677-1-ND	Z105	DIODE ZENER 33V 500MW SOD123	1	Digikey
75	BZT52C18-FDICT-ND	Z106	DIODE ZENER 18V 500MW SOD123	1	Digikey
76	3757-BZT52- B16_R1_00001CT-ND	Z107	DIODE ZENER 16V 500MW SOD123	1	Digikey
77	BZT52C8V2-FDICT-ND	Z108, Z109	DIODE ZENER 8.2V 500MW SOD123	2	Digikey

No.	Part number	Designator	Description	Quantity	Vendor
78	CR-BA-7C6-180D	Volume Knob	Round knob with Indicator Line	1	Newark
79	82K6096	Thermalloy TO-220 mounting kit with screw	MOUNTING KIT TO-220	3	Newark
80	8401K-ND	1/2" Standoffs 4-40	HEX STANDOFF #4-40 ALUMINUM 1/2"	5	Digikey
81	H724-ND	4-40 Nut	NUT HEX 4-40 STAINLESS STEEL	5	Digikey
82	H729-ND	No. 4 Lock Washer	WASHER LOCK INTERNAL #4 SS	5	Digikey

Note: * Tachyonix Corporation, 14 Gonaka Jimokuji Jimokuji-cho, Ama-gun Aichi, JAPAN 490-1111
<http://www.tachyonix.co.jp> email: info@tachyonix.co.jp

Table 9 Daughterboard BOM

No.	Part number	Designator	Description	Quantity	Vendor
1	490-1500-1-ND	C1, C2, C5, C6	CAP CER 2200PF 50V 10% X7R 0603	4	Digikey
2	587-2668-1-ND	C3, C4	CAP CER 10UF 10V X7R 10% 0805	2	Digikey
3	399-1082-1-ND	C7, C8	CAP 1000PF 50V CERAMICX7R 0603	2	Digikey
4	490-5519-1-ND	C9, C10	CAP CER 10UF 16V X6S 0805	2	Digikey
5	445-1418-1-ND	C11, C12, C17	CAP CER .10UF 100V X7R 10% 0805	3	Digikey
6	732-12081-1-ND	C13, C14, C15, C16	CAP CER 0.1UF 200V X7R 1206	4	Digikey
7	RF071MM2SCT-ND	D1, D2, D3, D4, D5	DIODE GEN PURP 200V 700MA PMDU	5	Digikey
	ES1DFSCCT-ND	D6, D7	DIODE GEN PURP 200V 1A DO214AC	2	Digikey
8	160-1183-1-ND	DS1(CLIP)	LED GREEN CLEAR 0603 SMD	1	Digikey
9	160-1181-1-ND	DS2(FAULT)	LED RED CLEAR 0603 SMD	1	Digikey
10	160-1646-1-ND	DS3(ON)	LED 468NM BLUE CLEAR 0603 SMD	1	Digikey
11	MA5302MS	IC1	2 CH PowlRaudio integrated Class D IC	1	Infineon

No.	Part number	Designator	Description	Quantity	Vendor
12	A26568-ND	J1A, J1B	CONN HEADER VERT 6POS .100 30AU	2	Digikey
13	A26570-ND	J2A, J2B	CONN HEADER VERT .100 8POS 30AU	2	Digikey
14	RMCF0603JT10R0CT- ND	R1, R2	RES 10 OHM 1/10W 5% 0603 SMD	2	Digikey
15	RMCF0603FT2K70CT- ND	R3, R4	RES 2.7K OHM 1/10W 1% 0603 SMD	2	Digikey
16	RMCF0603JT100RCT- ND	R5	RES 100 OHM 1/10W 5% 0603 SMD	1	Digikey
17	311-620GRCT-ND	R6, R7	RES 620 OHM 1/10W 5% 0603 SMD	2	Digikey
18	RHM10KGCT-ND	R8, R9, R17	RES 10K OHM 1/10W 5% 0603 SMD	3	Digikey
19	RMCF0603JT4R70CT- ND	R10, R11, R12	RES TF 1/10W 4.7 OHM 5% 0603	3	Digikey
20	RHM33KGCT-ND	R13, R14	RES 33K OHM 1/10W 5% 0603 SMD	2	Digikey
21	311-1.0ARCT-ND	R15, R16	RES 1.0 OHM 1/8W 5% 0805 SMD	2	Digikey
22*	V8818V	Heatsink	HEATSINK ALUM ANOD	1	Digikey
23	BER161-ND	Thermal pad	Thermal pad	1/8	Digikey
24	9191-4	Screws	MACH SCREW BINDING COMBO M3X0.5	2	Digikey
25	RPC9790-ND	Washer	LOCKING SEALING WASHER, 3.10MM I	2	Digikey

Revision history

Document version	Date of release	Description of changes
V 1.0		Initial release

Trademarks

All referenced product or service names and trademarks are the property of their respective owners.

Edition 2020-11-20

Published by

Infineon Technologies AG

81726 Munich, Germany

© 2023 Infineon Technologies AG.

All Rights Reserved.

Do you have a question about this document?

Email: erratum@infineon.com

Document reference

UM_1904_PL88_1910_133036

IMPORTANT NOTICE

The information given in this document shall in no event be regarded as a guarantee of conditions or characteristics ("Beschaffheitsgarantie").

With respect to any examples, hints or any typical values stated herein and/or any information regarding the application of the product, Infineon Technologies hereby disclaims any and all warranties and liabilities of any kind, including without limitation warranties of non-infringement of intellectual property rights of any third party.

In addition, any information given in this document is subject to customer's compliance with its obligations stated in this document and any applicable legal requirements, norms and standards concerning customer's products and any use of the product of Infineon Technologies in customer's applications.

The data contained in this document is exclusively intended for technically trained staff. It is the responsibility of customer's technical departments to evaluate the suitability of the product for the intended application and the completeness of the product information given in this document with respect to such application.

For further information on the product, technology delivery terms and conditions and prices please contact your nearest Infineon Technologies office (www.infineon.com).

WARNINGS

Due to technical requirements products may contain dangerous substances. For information on the types in question please contact your nearest Infineon Technologies office.

Except as otherwise explicitly approved by Infineon Technologies in a written document signed by authorized representatives of Infineon Technologies, Infineon Technologies' products may not be used in any applications where a failure of the product or any consequences of the use thereof are reasonably expected to result in personal injury.