

FEATURES

- Demonstrates a complete digitally-controlled microphone preamplifier circuit based on THAT5173 IC
- Controls gain of the 1580 or 1583 microphone preamplifier.
- Balanced audio input/output on XLR and TRS connectors
- Supports pro audio signal levels: +26 dBu (input and output, $\pm 15V$ supplies)
- Gain adjustable in 3 dB steps from 0 dB to 60 dB
- Easy to use PC Graphical User Interface software
- Generous prototyping area

Description

The THAT 5173-DEMO Digitally-Controlled Mic Preamp Demo Board allows developers to evaluate the THAT5173 digital gain controller IC with any member of the growing family of THAT differential output microphone preamplifiers. A fully-featured

microphone preamplifier is demonstrated with phantom power switching and fault protection, mic/line switching, RFI filtering, and output conditioning. The board is controlled by a user-friendly PC graphical user interface over USB.

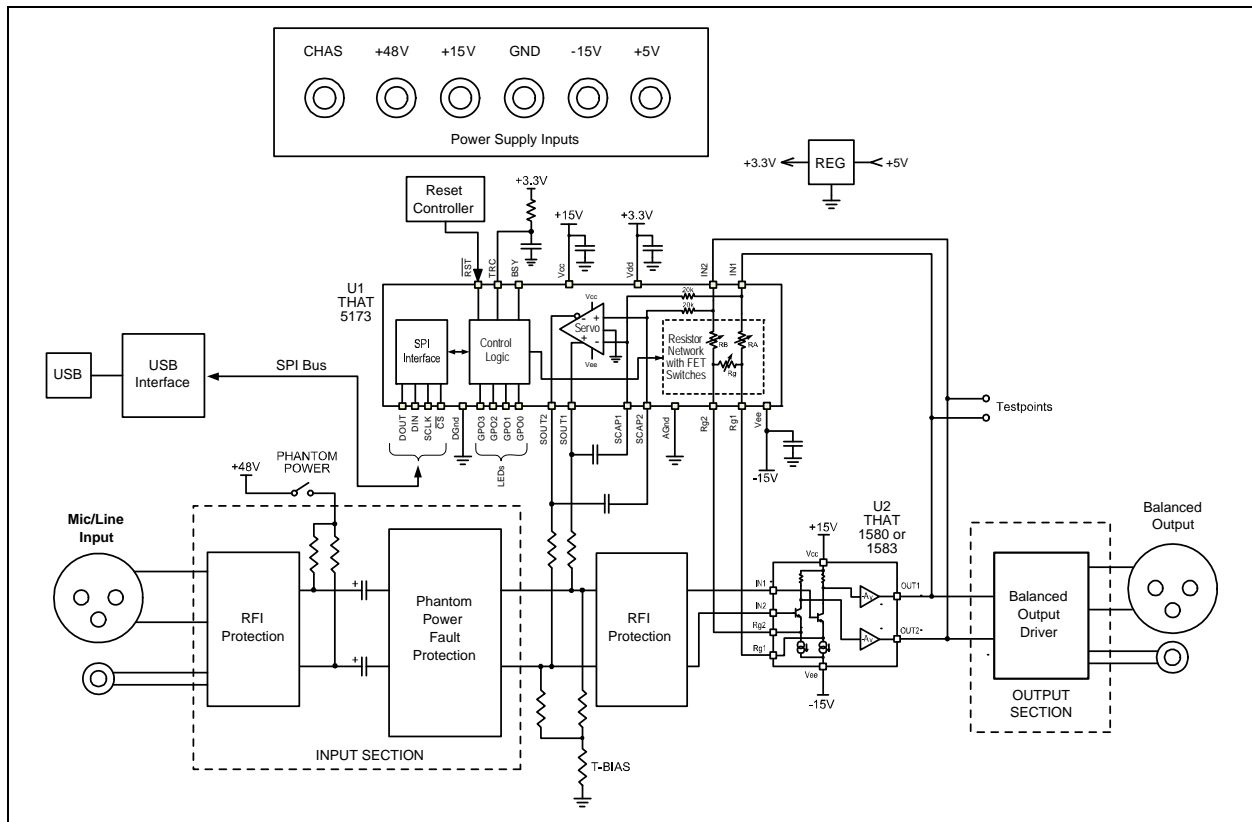

Figure 1. Block Diagram of the THAT 5173 Demo Board

Overview

The THAT5173 is a digital gain controller for low-noise, analog, differential, current-feedback audio preamplifiers. When used in conjunction with an appropriate analog gain block (e.g. THAT1580 or THAT1583), the 5173 can digitally control gain from 0dB to 60dB in 3dB steps, while preserving low noise and distortion. It operates from $\pm 5V$ to $\pm 17V$ supplies, supporting input signal levels as high as +27 dBu (at 0dB gain,

$\pm 17V$) without an input pad. A differential servo reduces output offsets to less than 1.75mV.

The THAT5173-DEMO Board demonstrates the 5173 mated with either the 1580 or 1583 mic preamplifier IC in a typical circuit. An easy to use USB Graphical User Interface provides total control over all 5173 features. Developers can take advantage of the generous prototyping area to customize the circuit for their own application.

Connections

Power

The USB interface runs on USB bus power, but the rest of the demo board requires an external power supply. +/-15 V (maximum +/-17V) supplies the analog circuitry. +48V phantom power is input (not generated on the board) and switched on and off via the on-board Phantom Power switch. Note that the ground return for +48V phantom power is via the CHAS (chassis ground) connector. The +5V input is regulated on board to 3.3V and supplies the digital logic.

Audio Input

The Neutrik combo connector accepts an XLR or ¼" TRS cable. The ¼" TRS signal path includes a 20dB pad in order to support line levels.

Audio Output

Separate XLR and ¼" TRS connectors are wired in parallel. differential attenuator/ output buffer (U3) adds a small amount of noise and

distortion to the signal and it is therefore recommended that test points TP10 - TP11 be used to measure performance of the mic preamp circuit in isolation.

USB

A PC must be plugged into the demo board via USB in order to control parameters in the 5173 (e.g. gain). Take care not to hot plug the demo board while the GUI software is running as this will sometimes crash the Windows drivers.

General Purpose Outputs (GPO)

The GPO3:0 pins are connected to header P6. P6 is conveniently located near the prototyping area, so the user can easily connect optional circuitry to them. Note that the GPO pins are also connected to LEDs, D1-D4, and pull up and pull down resistors which set the 5173 device address during reset. Consideration must be given to how any application circuitry that is added interacts with these other functions.

Hardware Set-up

1. Connect a power supply to the V+, V-, +5V, +48V, CHAS and GND connectors. Do not turn on power yet.
2. Plug in the audio input and output
3. Attach a USB cable to the demo board, but do not plug it into the PC yet
4. Turn on the power supply
5. Turn on phantom power to microphone (if appropriate)

6. Plug USB cable into PC. Windows should go through its procedure for discovering the new USB peripheral and loading its driver.

7. Once the Windows driver has been loaded, launch the THAT Corporation MicPreController GUI application. See software section (below) for further instructions on operating the GUI.

8. When finished, close the MicPreController GUI first, then power down the demo board.

Software Set-up

If you see an error during installation

The 5173 Demo Board GUI application requires Microsoft .NET Framework 3 or later to be installed on your computer. If you see an error message during installation stating the application could not be installed, 99% of the time it's because you don't have .NET. Please visit: <http://www.microsoft.com/download/en-us/details.aspx?id=17718> and install the latest version.

Installing the 5173 Demo Board Software

NOTE: Do NOT plug the demo board into your PC yet. We'll tell you when to do that.

PC Software Installation Process

1. Get the software, a single file named THAT5173_Demo_Setup.exe. The software is available via download from the THAT Corporation website on the following page: www.thatcorp.com/Demonstration_Boards.shtml

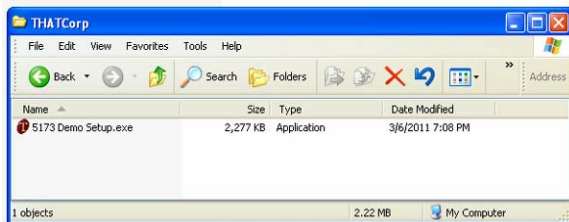

Figure 2. THAT5173_Demo_Setup.exe setup program in a folder

2. Double click the THAT5173_Demo_Setup.exe icon. Windows might warn you: "The publisher could not be verified. Are you sure you want to run this software?" (Figure 3). This is a standard security warning presented by Windows when files from unknown origins are opened. Consider where you got this. On a bit torrent file sharing site? Don't open it. From us, click RUN.



Figure 3. Windows warning, just click RUN.

3. Next, you must tell Windows to go ahead and install the Software, as shown in Figure 4. Click INSTALL.

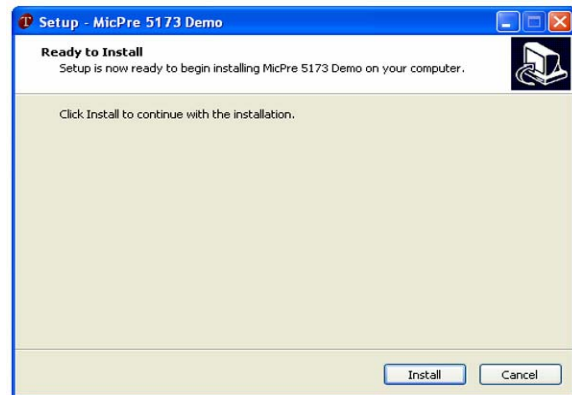

Figure 4. Start the installation process (USB drivers first)

4. You should see the automated wizard step through a series of steps as it plugs in the requisite USB drivers. When it's done, the wizard invites you to install the GUI, as shown in Figure 5. Click NEXT.



Figure 5. Starting the GUI installation process

5. The first thing the wizard asks is where you want to put the GUI (Figure 6). We recommend a THAT Corp folder, as shown in the figure. Navigate to where you want the GUI to be installed, and then click NEXT.

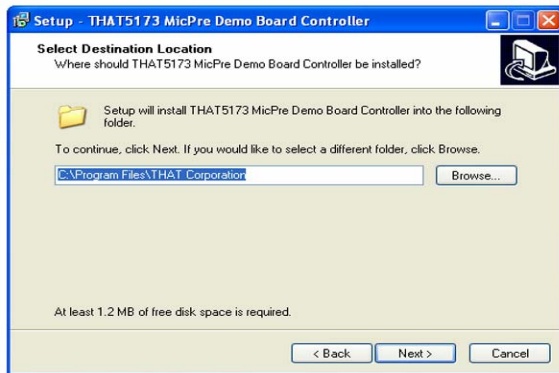

Figure 6. Selecting the software hard disk location

6. Next, Windows asks where it should put the Shortcut icons for the GUI (Figure 7). If you agree with our recommendation, just click NEXT. Otherwise, change this setting to what you want and then click NEXT.

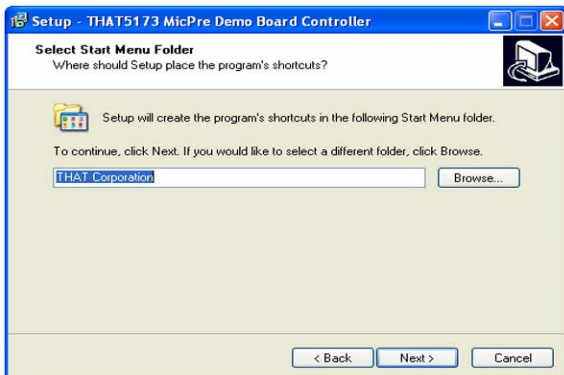

Figure 7. Selecting the start menu folder

7. Now Windows asks if you want a Desktop icon (Figure 8). We will leave that to you to decide (this is your homework). Once you've made your decision, click NEXT.

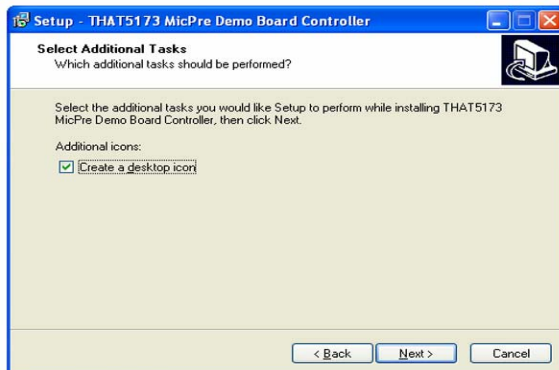

Figure 8. Selecting a desktop icon

8. Finally, the wizard will stop asking you questions and get on with the business of installing the GUI, as shown in Figure 9. Click INSTALL.

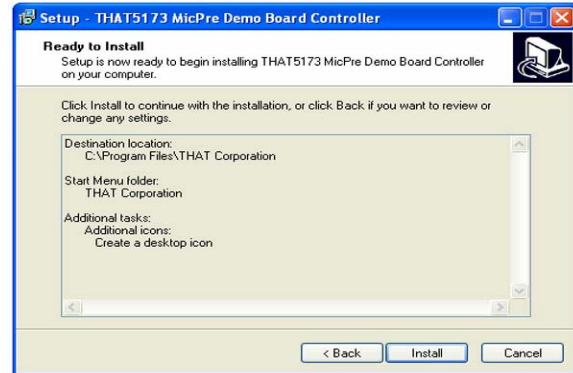

Figure 9. Ready to install

9. When the wizard is finished, you should see the final dialog box shown in Figure 10. Click FINISH.



Figure 10. Finishing the GUI installation process

10. The software installation wizard is done now, but there is one final step. Windows and the 5173 Demo Board must see each other for the first time. Their first encounter is special because it's when Windows discovers a new USB device and attaches those new drivers you just installed to it. It is not required that the Demo Board be connected to an external supply for this process to work, the USB interface on the Demo Board is actually bus-powered by USB. So, plug the Demo Board into your PC and watch them get to know each other (you'll see little messages flash in the lower right corner). Hopefully Windows will report a happy marriage. If not, get a fresh cup of coffee (or whatever you drink in distress), and call our tech support hotline.

11. That's it. You're done. Enjoy.

Operation

1. Apply power to the demo board, then plug the demo board into the PC via USB.

2. Launch the MicPreController GUI application.

3. The USB interface on the demo board will appear in Windows as a new COM port.

4. The GUI should now be connected to the demo board and ready to control its parameters. The GPO 0 check box is selected by default, and the GPO 0 LED should now be lit on the demo board indicating that communications have been established. If the LED is not turned on, or anytime USB communication has been disrupted, use the "Reconnect" command from the Port drop down menu to re-establish the USB connection.

5. Select "Update immediately" or "Update on zero crossings" from the Gain Mode and GPO Mode drop down menus.

6. Move the gain slider to adjust gain of the 5173. Gains are continuously adjusted as you move the slider. You may also adjust the gain slider by first giving it scope (clicking it with the mouse) and then pressing the UP and DOWN arrow keys on your computer keyboard, or by clicking the up or down arrow buttons next to the numeric gain text box below the gain slider.

Jumper Options

T-Bias Jumper, P7

The input circuit provides a jumper (P7) which enables/disables the "T-Bias" function. With a shunt installed on P7, T-Bias is disabled and the circuit provides a 2k Ω differential input impedance to the XLR input. With the shunt removed from P7, T-Bias is enabled and provides a high common mode impedance (ideal for both mic and line inputs) but maintains a modest differential impedance.

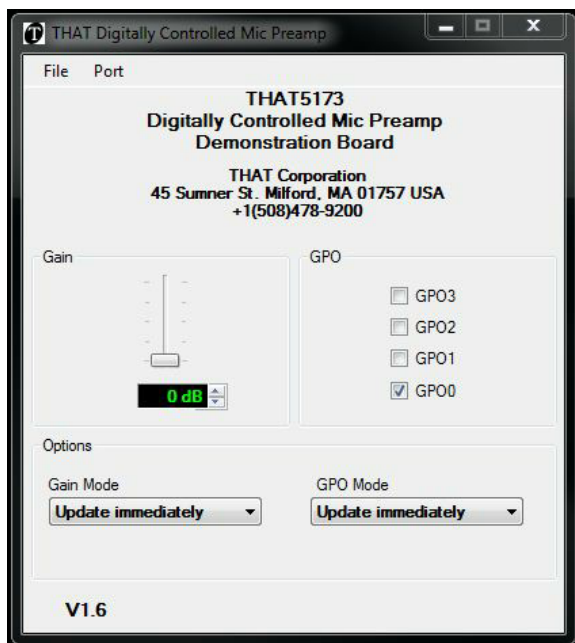
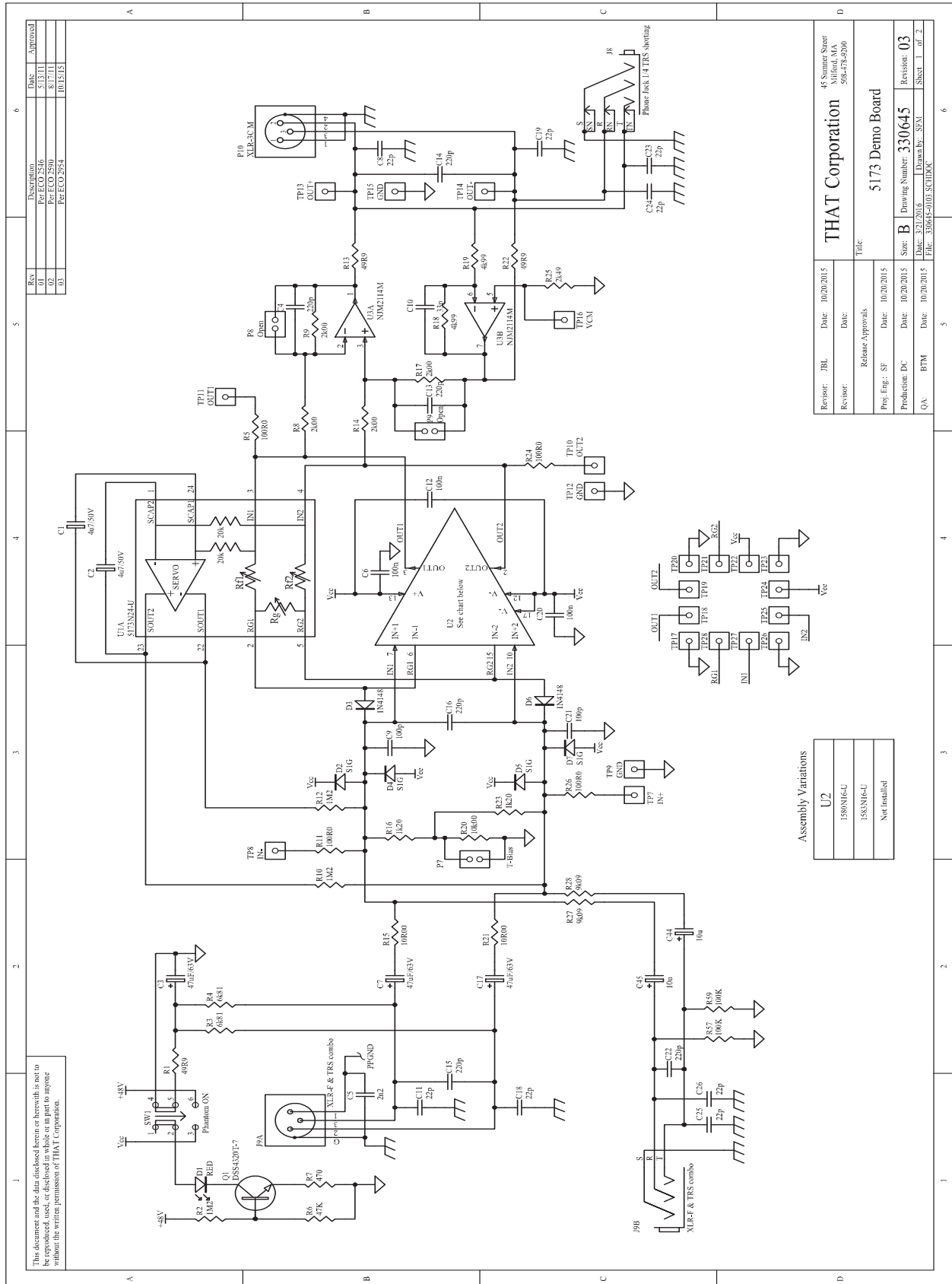
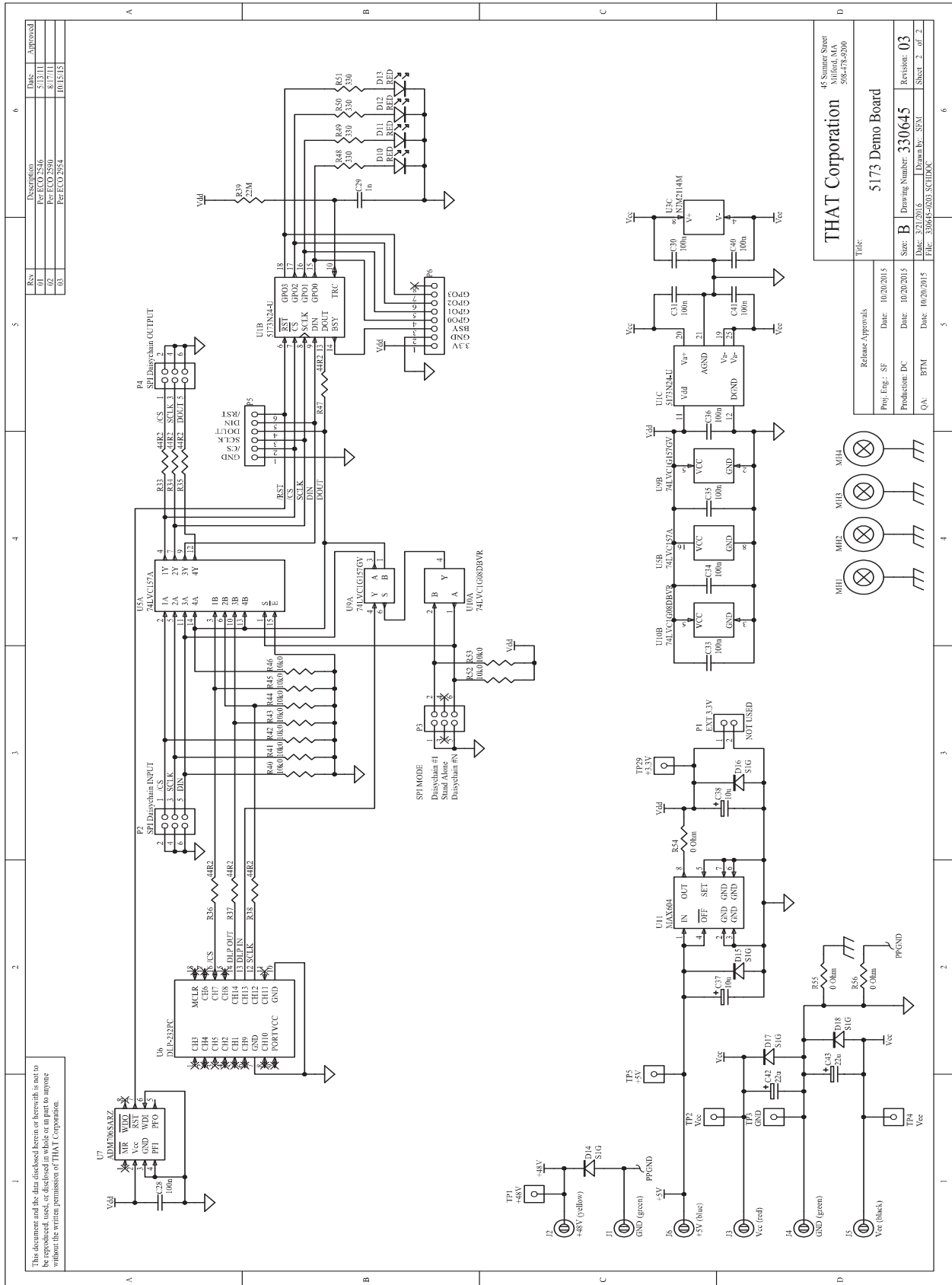

Figure 11. Control GUI

Appendix A. Schematic (1 of 2)



Appendix A. Schematic (2 of 2)



Appendix B. Bill of Materials

Item	Qty	Reference	Title	Detail	Mfr	Mfr P/N
1	2	R57, R59	RESISTOR	100K 100MW 1% THICK FILM 100 PPM 0603	Vishay Dale	CRCW0603100KFKEA
2	3	R54, R55, R56	RESISTOR	0R 100MW 5% THICK FILM 200 PPM 0603	Panasonic	ERJ-3GEY0R00V
3	9	R40, R41, R42, R43, R44, R45, R46, R52, R53	RESISTOR	10K0 100MW 1% THICK FILM 100 PPM 0603	Vishay Dale	CRCW06031002FRT1
4	7	R33, R34, R35, R36, R37, R38, R47	RESISTOR	44R2 100MW 1% THICK FILM 100 PPM 0603	KOA Speer Electronics	RK73H1JTDD44R2F
5	2	R15, R21	RESISTOR	10R00 1/4W 0%1 MF 50 PPM AXIAL	IRC	RC55-D-10R-B-B
6	2	R3, R4	RESISTOR	6K81 1/4W 0%1 MF 25 PPM AXIAL	IRC	RC55LF-D-6K81-B-B
7	1	R1	RESISTOR	49R90 1/4W 0%1 MF 25 PPM1206	Vishay Dale	TNPW120649R9BEEN
8	2	R13, R22	RESISTOR	49R90 1/10W 0%1 THIN FILM 25 PPM 0805	Stackpole Electronics	RNCS0805BKE49R9
9	4	R5, R11, R24, R26	RESISTOR	100R0 100MW 1% THIN FILM 25 PPM 0805	KOA Speer Electronics	RN732ATTD1000F25
10	1	R20	RESISTOR	10K00 100MW 0%5 THIN FILM 25 PPM 0805	Susumu Co	RR1220P-103-D
11	2	R16, R23	RESISTOR	1K20 0.25W 0%1 THIN FILM 25 PPM 0805	KOA Speer Electronics	RN732ATTD1201B25
12	3	R2, R10, R12	RESISTOR	1M2 0.125W 1% TF 100 PPM 0805	Vishay Dale	CRCW08051M21FKEA
13	4	R8, R9, R14, R17	RESISTOR	2K00 100MW 0%1 THIN FILM 25 PPM 0805	Susumu	RR1220P-202-B-T5
14	2	R27,R28	RESISTOR	9K09 125MW 0%1 THIN FILM 25 PPM 0805	Susumu Co	RG2012P-9091-B-T5
15	2	R18, R19	RESISTOR	4K99 100MW 0%5 THIN FILM 25 PPM 0805	Susumu	RR1220P-4991-D-M
16	1	R6	RESISTOR	47K0 125MW 1% THIN FILM 100 PPM 0805	Yageo	RC0805FR-0747KL
17	1	R7	RESISTOR	470R 125MW 1% TF 100 PPM 0805	Yageo	RC0805FR-07470RL
18	1	R25	RESISTOR	2K49 125MW 1% THIN FILM 100 PPM 0805	Stackpole Electronics	RNCP0805FTD2K49
19	4	R48, R49, R50, R51	RESISTOR	330R 125MW 1% TF 100 PPM 0805	Yageo	RC0805FR-07330RL
20	1	R39	RESISTOR	22M 125MW 1% TF 100 PPM 0805	Panasonic	ERJ-6GEYK226V
21	2	C44, C45	CAPACITOR	10U 20% 50V ALUMINUM SMT	Nichicon	UWX1H100MCL1GB
22	1	C29	CAPACITOR	1N 10% 50V X7R CM 0603	AVX Corporation	06035C102KAT2A
23	9	C28, C30, C31, C33, C34, C35, C36, C40, C41	CAPACITOR	100N 10% 50V X7R CM 0603	Murata Electronics	GRM188R71H104KA93D
24	3	C6, C12, C20	CAPACITOR	100N 10% 50V X7R CM 0805	Murata Electronics	GRM21BR71H104KA01L
25	2	C9, C21	CAPACITOR	100P 10% 50V X7R CM 0805	Murata Electronics	GRM2165C1H101JA01D
26	6	C4, C13, C14, C15, C16, C22	CAPACITOR	220P 5% 50V NP0 CM LOW ESR 0805	AVX	08055A221JAT2A
27	8	C8, C11, C18, C19, C23, C24, C25, C26	CAPACITOR	22P 5% 50V NP0 CM LOW ESR 0805	Sunsung	CL21C220JBANNNC
28	1	C10	CAPACITOR	33P 5% 50V NP0 CM LOW ECR 0805	Panasonic	ECJ-2VC1H330J
29	1	C5	CAPACITOR	2N2 20% 100V X7R CM 0805	Johanson Dielectrics Inc	101X15W222MV4E
30	2	C37, C38	CAPACITOR	10U 20% 25V ALUMINUM SMT	United Chemi-Con, Inc.	EMVA250ADA100MD55G
31	2	C42, C43	CAPACITOR	22U 20% 25V ALUMINUM LOW IMP SMT	Panasonic	EEV-FC1E220P
32	3	C3, C7, C17	CAPACITOR	47U 20% 63V AL LOW ESR SMT	Panasonic	EEE-TG1J470P
33	2	C1, C2	CAPACITOR	4U7 20% 50V ALUMINUM SMT BP	Nichicon	UWP1H4R7MCL1GB
34	9	D2, D4, D5, D7, D14, D15, D16, D17, D18	DIODE	RECTIFIER 1A 400V DO-214AC S1G	Diodes, Inc.	S1G-13-F
35	2	D3, D6	DIODE	SWITCHING 150MA 75V 0603 1N4148	Comchip Technology Corporation	CDSU4148
36	1	Q1	TRANSISTOR	BIPOLAR NPN 20V 2A SOT-23DSS4320T-7	Diodes, Inc.	DSS4320T-7
37	5	D1, D10, D11, D12, D13	LED	RED HIGH BRIGHTNESS	Rohm	SLA-560LT3F
38	1	U7	IC	UP SUPERVISORY CIRCUIT 3V SOIC-8 ADM706SAR	Analog Devices	ADM706SARZ
39	1	U11	IC	REGULATOR VOLTAGE LOW DROP 3.3V SO-8 MAX604CSA	Maxim / Dallas	MAX604CSA+
40	1	U3	IC	OP AMP DUAL LOW NOISE DMP-8 NJM2114M	NJR Corporation	NJM2114M

Item	Qty	Reference	Value	Description	Mfr	Mfr P/N
41	1	U5	IC	MULTIPLEXER QUAD 2 INPUT 74LVC157ADB	NXP Semiconductors	74LVC157ADB,118
42	1	U9	IC	MULTIPLEXER SINGLE 2 INPUT 74LVC1G157GV,125	NXP Semiconductors	74LVC1G157GV,125
43	1	U10	IC	AND GATE SINGLE SMT SN74LVC1G08DBVR	Texas Instruments	SN74LVC1G08DBVR
44	1	U2	IC	IC LOW NOISE DIFFERENTIAL PREAMPLIFIER	THAT Corporation	1580N16-U or 1583N16-U
45	1		LABEL	MODEL NUMBER 1.10" X 0.25" 5173/1580 or 1583		
46	1	Install on SW1	SWITCH BUTTON	BUTTON 0.2" DIA X 0.35" LONG DARK GRAY	E-Switch	1RDGR
47	1	SW1	SWITCH	PUSHBUTTON DPDT	E-Switch	PBH2UEENAGX
48	1		PCB	DEMO BOARD 5173N24		3760-6
49	1	J6	CONN	1P BINDING POST CHASSIS MNT BLUE	Pomona Electronics	3760-6
50	1	J2	CONN	1P BINDING POST CHASSIS MNT YELLOW	Pomona Electronics	3760-4
51	3	P2, P3, P4	CONN	60P 3 X 2 MALE GOLD	3M	2306-6121TG
52	3	P7, P8, P9	CONN	2P MALE STR GOLD 0.1" 2 X 1	Samtec USA	TSW-102-07-G-S
53	1	P5	CONN	6P MALE GOLD 0.1" 6 X 1	Molex	22-28-4063
54	1	P6	CONN	8P 8 X 1 MALE GOLD 0.1"	Molex	22-28-4083
55	1	P1	CONN	2P 2 X 1 MALE STR LOCKING GOLD 0.1"	Molex	22-11-2022
56	1	J3	CONN	1P BINDING POST CHASSIS MNT RED	Pomona Electronics	3760-2
57	2	J1, J4	CONN	1P BINDING POST CHASSIS MNT GREEN	Pomona Electronics	3760-5
58	1	J5	CONN	1P BINDING POST CHASSIS MNT BLACK	Pomona Electronics	3760-0
59	16	TP1, TP2, TP3, TP4, TP5, TP7, TP8, TP9, TP10, TP11, TP12, TP13, TP14, TP15, TP16, TP29	CONN	1P 1 X 1 TEST POINT SMT 0.015 THICK	Keystone Electronics Corporation	5016
60	1	P10	CONN	3P XLR-3C MALE RT ANGLE	Neutrik USA Inc.	NC3MAH
61	1	J9	CONN	3P XLR - COMBO STEREO RT ANGLE	Neutrik USA Inc.	NCJ6FI-H
62	1	J8	CONN	3P PHONE FEMALE RT ANGLE 1/4" STEREO SLIM JACK	Neutrik USA Inc.	NRJ6HF-1
63	4	MH1, MH2, MH3, MH4	STANDOFF	STANDOFF 4-40 X 1/4" X 1" HEX SWAGE BRASS	RAF	3559-B-440-B-0
64	1	U6	PCBA	MODULE USB MICROCONTROLLER DLP-232PC	DLP Design, Inc	DLP-232PC
65	1	U1	IC	IC AUDIO PREAMP DIGITAL CONTROLLER	THAT Corporation	5173N24-U
66	2	Install on P3 & P7	CONN	2P SHUNT FEMALE GOLD 0.1" 2 X 1 BLACK	Kobiconn	151-8000-E
67	1		LABEL	Barcode Label for DEMO BOARDS		

Appendix C. PCB Layout (2 of 3)

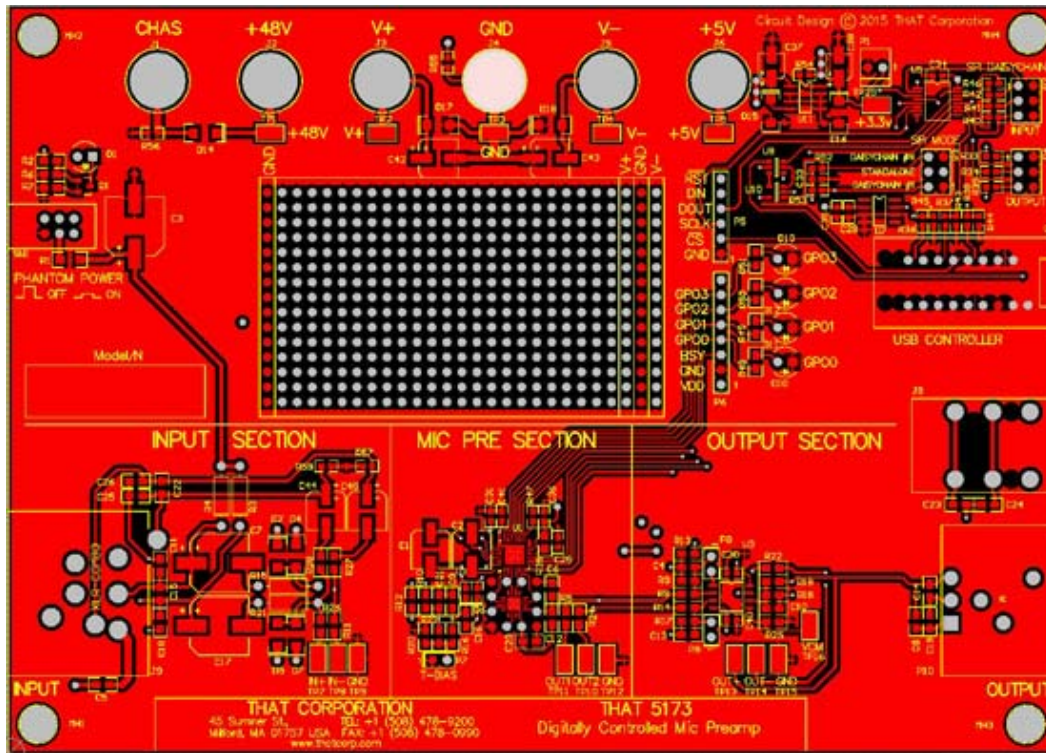

Layer 1 (Top with component screen)

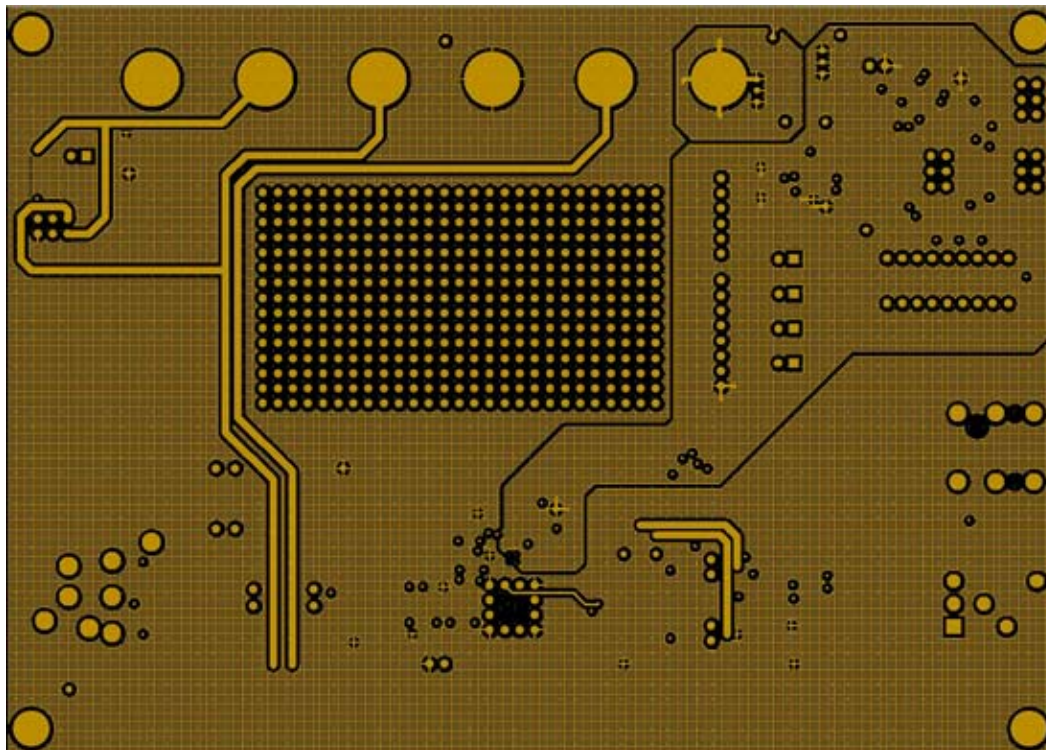

Layer 2 (Power)

Appendix C. PCB Layout (3 of 3)

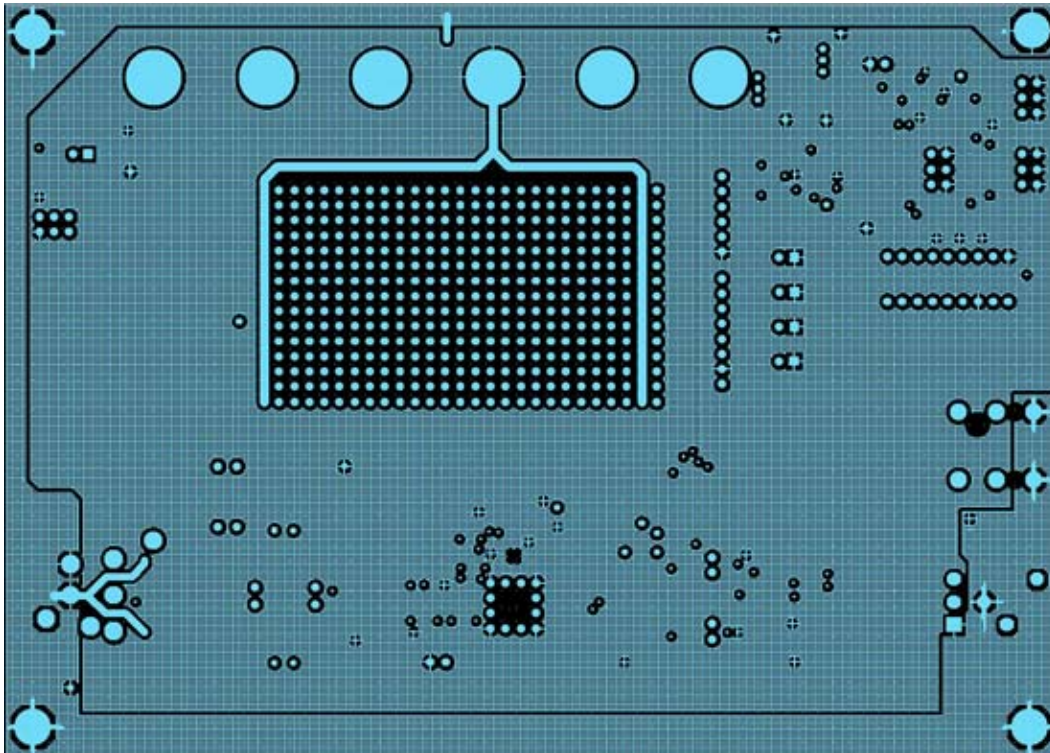

Layer 3 (Ground)

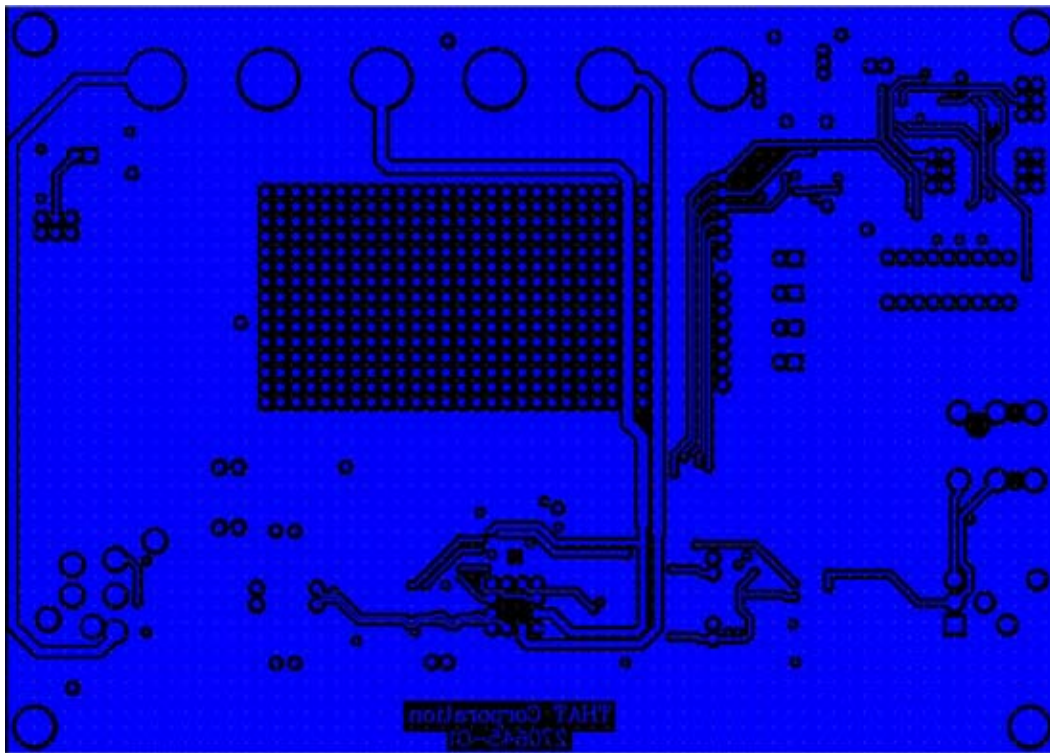

Layer 4 (Bottom)

Appendix D. 5173 + 1580 Specifications¹

Parameter	Symbol	Typical	Units
Power Supply Voltage	V+ - V-	±15	V
Maximum Input Level (V+ /V- = ±15V)	V _{in-BAL}	+26.0	dBu
Maximum Differential Output Level (V+ /V- = ±15V)	V _{OUT}	+26.8	dBu
Gain (input to output)	A _{dB}	0 to 60 in 3dB steps	dB
Gain error (all settings)	A _{err}	±0.2 (typical)	dB
Total Harmonic Distortion + N (V _{OUT} = +16dBu (5V _{RMS}); R _L = 10kΩ; C _L = 10 pF; f = 1kHz; BW = 22 kHz)	THD+N	0.0006 (0dB gain) 0.0005 (+21dB gain) 0.001 (+39dB gain) 0.005 (+60dB gain)	%
Equivalent Input Noise, Main Output (R _{SOURCE} =150 Ω, BW=22kHz)	EIN	-127.3 (+60dB gain) -125.3 (+39dB gain) -117.4 (+21dB gain) -104.8 (0dB gain)	dBu
Equivalent Input Noise, 1580 Output (R _{SOURCE} =150 Ω, BW=22kHz)	EIN	-127.3 (+60dB gain) -125.3 (+39dB gain) -117.5 (+21dB gain) -106 (0dB gain)	dBu
Supply Current	I _{CC} ; -I _{EE} , I _{DD}	27 (V+ supply) 27 (V- supply) 15 (+5V supply, all LEDs on)	mA

1. All specifications are subject to change without notice.

2. Unless otherwise specified, T_A=25°C, V_{CC}=+15V, V_{EE}=-15V, V_{DD}=+3.3V

Appendix E. 5173 + 1583 Specifications¹

Parameter	Symbol	Typical	Units
Power Supply Voltage	V+ - V-	±15	V
Maximum Input Level (V+ /V- = ±15V)	V _{in-BAL}	+26.4	dBu
Maximum Differential Output Level (V+ /V- = ±15V)	V _{OUT}	+27.8	dBu
Gain (input to output)	A _{dB}	0 to 60 in 3dB steps	dB
Gain error (all settings)	A _{err}	±0.2 (typical)	dB
Total Harmonic Distortion + N (V _{OUT} = +16dBu (5V _{RMS}); R _L = 10kΩ; C _L = 10 pF; f = 1kHz; BW = 22 kHz)	THD+N	0.001% (0dB gain) 0.001% (+21dB gain) 0.001% (+39dB gain) 0.008% (+60dB gain)	%
Equivalent Input Noise, Main Output (R _{SOURCE} =150 Ω, BW=22kHz)	EIN	-124.8 (+60dB gain) -122.4 (+39dB gain) -112.3 (+21dB gain) -99.2 (+0dB gain)	dBu
Equivalent Input Noise, 1583 Output (R _{SOURCE} =150 Ω, BW=22kHz)	EIN	-124.8 (+60dB gain) -122.4 (+39dB gain) -112.3 (+21dB gain) -99.3 (+0dB gain)	dBu
Supply Current	I _{CC} ; -I _{EE} , I _{DD}	27 (V+ supply) 27 (V- supply) 15 (+5V supply, all LEDs on)	mA

1. All specifications are subject to change without notice.

2. Unless otherwise specified, T_A=25°C, V_{CC}=+15V, V_{EE}=-15V, V_{DD}=+3.3V

FCC Warning

This device is only intended for laboratory test environments. It may radiate radio frequency energy and has not been tested for compliance with subpart

J of part 15 of the FCC regulations. Operation of this device in other environments may cause interference with radio communications.

Revision History

Revision	ECO	Date	Changes	Page
00	—	04/09/2012	Released	—
01	2757	02/05/2013	Added references to THAT1583	—
02	2923	05/28/2015	Added references to THAT1580	—
03	2940	09/10/2015	Minor correction to 5173/1580 specs	16
04	2954	03/22/2016	Removed 1570, Fixed silkscreen errors, Removed Instrument Input and it's associated components.	—