

High Efficiency LED in \varnothing 3 mm Tinted Diffused Package

Color	Type	Technology	Angle of Half Intensity $\pm\varphi$
High efficiency red	TLHR44..	GaAsP on GaP	30°
Soft orange	TLHO44..	GaAsP on GaP	30°
Yellow	TLHY44..	GaAsP on GaP	30°
Green	TLHG44..	GaP on GaP	30°
Pure green	TLHP44..	GaP on GaP	30°

Description

The TLH.44.. series was developed for standard applications like general indicating and lighting purposes.

It is housed in a 3 mm tinted diffused plastic package. The wide viewing angle of these devices provides a high on-off contrast.

Several selection types with different luminous intensities are offered. All LEDs are categorized in luminous intensity groups. The green and yellow LEDs are categorized additionally in wavelength groups.

That allows users to assemble LEDs with uniform appearance.

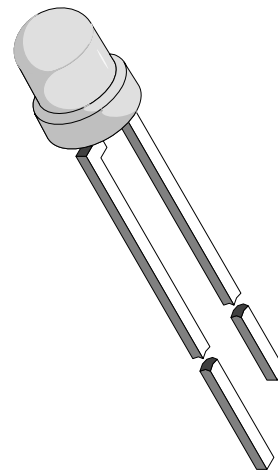

94 8488

Features

- Standard T-1 package
- Small mechanical tolerances
- Suitable for DC and high peak current
- Wide viewing angle
- Luminous intensity categorized
- Yellow and green color categorized

Applications

Status lights
 OFF / ON indicator
 Background illumination
 Readout lights
 Maintenance lights
 Legend light

Absolute Maximum Ratings

$T_{amb} = 25^{\circ}\text{C}$, unless otherwise specified

TLHR44.., TLHO44.., TLHY44.., TLHG44.., TLHP44..

Parameter	Test Conditions	Symbol	Value	Unit
Reverse voltage		V_R	6	V
DC forward current		I_F	30	mA
Surge forward current	$t_p \leq 10 \mu\text{s}$	I_{FSM}	1	A
Power dissipation	$T_{amb} \leq 60^{\circ}\text{C}$	P_V	100	mW
Junction temperature		T_j	100	$^{\circ}\text{C}$
Operating temperature range		T_{amb}	-20 to +100	$^{\circ}\text{C}$
Storage temperature range		T_{stg}	-55 to +100	$^{\circ}\text{C}$
Soldering temperature	$t \leq 5 \text{ s}$, 2 mm from body	T_{sd}	260	$^{\circ}\text{C}$
Thermal resistance junction/ambient		R_{thJA}	400	K/W

Optical and Electrical Characteristics

$T_{amb} = 25^{\circ}\text{C}$, unless otherwise specified

High efficiency red (TLHR44..)

Parameter	Test Conditions	Type	Symbol	Min	Typ	Max	Unit
Luminous intensity	$I_F = 10 \text{ mA}$, $I_{Vmin}/I_{Vmax} \geq 0.5$	TLHR4400	I_V	1.6	3		mcd
		TLHR4401	I_V	2.5	5		mcd
		TLHR4405	I_V	6.3	10		mcd
Dominant wavelength	$I_F = 10 \text{ mA}$		λ_d	612		625	nm
Peak wavelength	$I_F = 10 \text{ mA}$		λ_p		635		nm
Angle of half intensity	$I_F = 10 \text{ mA}$		ϕ		± 30		deg
Forward voltage	$I_F = 20 \text{ mA}$		V_F		2	3	V
Reverse voltage	$I_R = 10 \mu\text{A}$		V_R	6	15		V
Junction capacitance	$V_R = 0$, $f = 1 \text{ MHz}$		C_j		50		pF

Soft orange (TLHO44..)

Parameter	Test Conditions	Type	Symbol	Min	Typ	Max	Unit
Luminous intensity	$I_F = 10 \text{ mA}$, $I_{Vmin}/I_{Vmax} \geq 0.5$		I_V	1.6	4		mcd
Dominant wavelength	$I_F = 10 \text{ mA}$	TLHO4400	λ_d	598		611	nm
Peak wavelength	$I_F = 10 \text{ mA}$		λ_p		605		nm
Angle of half intensity	$I_F = 10 \text{ mA}$		ϕ		± 30		deg
Forward voltage	$I_F = 20 \text{ mA}$		V_F		2.4	3	V
Reverse voltage	$I_R = 10 \mu\text{A}$		V_R	6	15		V
Junction capacitance	$V_R = 0$, $f = 1 \text{ MHz}$		C_j		15		pF



Yellow (TLHY44..)

Parameter	Test Conditions	Type	Symbol	Min	Typ	Max	Unit
Luminous intensity	$I_F = 10 \text{ mA}$, $I_{Vmin}/I_{Vmax} \geq 0.5$	TLHY4400	I_V	1.6	3		mcd
		TLHY4401	I_V	2.5	5		mcd
		TLHY4405	I_V	6.3	10		mcd
Dominant wavelength	$I_F = 10 \text{ mA}$		λ_d	581		594	nm
Peak wavelength	$I_F = 10 \text{ mA}$		λ_p		585		nm
Angle of half intensity	$I_F = 10 \text{ mA}$		ϕ		± 30		deg
Forward voltage	$I_F = 20 \text{ mA}$		V_F		2.4	3	V
Reverse voltage	$I_R = 10 \mu\text{A}$		V_R	6	15		V
Junction capacitance	$V_R = 0$, $f = 1 \text{ MHz}$		C_j		50		pF

Green (TLHG44..)

Parameter	Test Conditions	Type	Symbol	Min	Typ	Max	Unit
Luminous intensity	$I_F = 10 \text{ mA}$, $I_{Vmin}/I_{Vmax} \geq 0.5$	TLHG4400	I_V	2.5	4		mcd
		TLHG4401	I_V	4	6		mcd
		TLHG4405	I_V	6.3	12		mcd
Dominant wavelength	$I_F = 10 \text{ mA}$		λ_d	562		575	nm
Peak wavelength	$I_F = 10 \text{ mA}$		λ_p		565		nm
Angle of half intensity	$I_F = 10 \text{ mA}$		ϕ		± 30		deg
Forward voltage	$I_F = 20 \text{ mA}$		V_F		2.4	3	V
Reverse voltage	$I_R = 10 \mu\text{A}$		V_R	6	15		V
Junction capacitance	$V_R = 0$, $f = 1 \text{ MHz}$		C_j		50		pF

Pure green (TLHP44..)

Parameter	Test Conditions	Type	Symbol	Min	Typ	Max	Unit
Luminous intensity	$I_F = 10 \text{ mA}$, $I_{Vmin}/I_{Vmax} \geq 0.5$	TLHP4400	I_V	0.63	2		mcd
		TLHP4401	I_V	1	3		mcd
		TLHP4405	I_V	1.6	3.5		mcd
Dominant wavelength	$I_F = 10 \text{ mA}$		λ_d	555		565	nm
Peak wavelength	$I_F = 10 \text{ mA}$		λ_p		555		nm
Angle of half intensity	$I_F = 10 \text{ mA}$		ϕ		± 30		deg
Forward voltage	$I_F = 20 \text{ mA}$		V_F		2.4	3	V
Reverse voltage	$I_R = 10 \mu\text{A}$		V_R	6	15		V
Junction capacitance	$V_R = 0$, $f = 1 \text{ MHz}$		C_j		50		pF



Typical Characteristics ($T_{amb} = 25^{\circ}\text{C}$, unless otherwise specified)

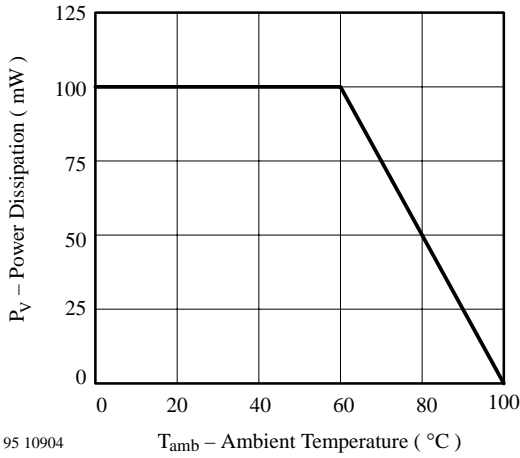

Figure 1 Power Dissipation vs. Ambient Temperature

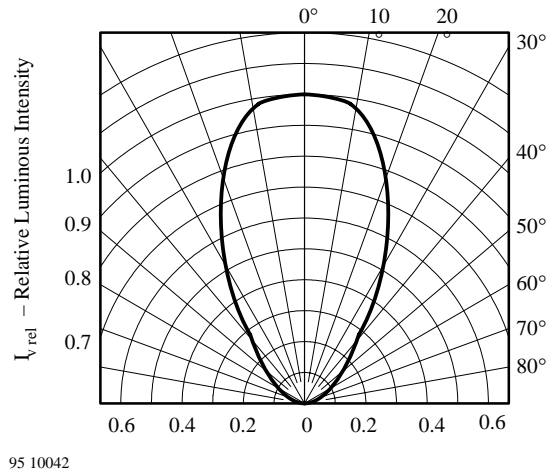

Figure 4 Rel. Luminous Intensity vs. Angular Displacement

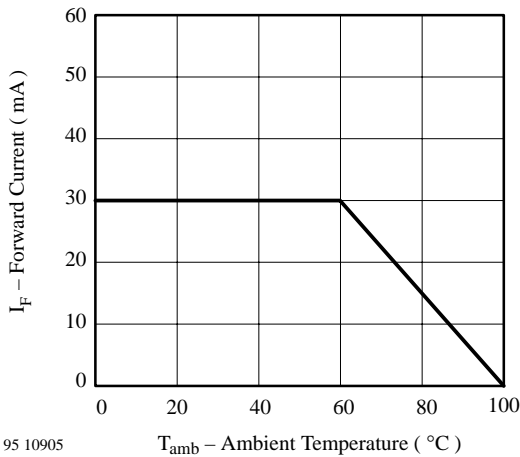

Figure 2 Forward Current vs. Ambient Temperature

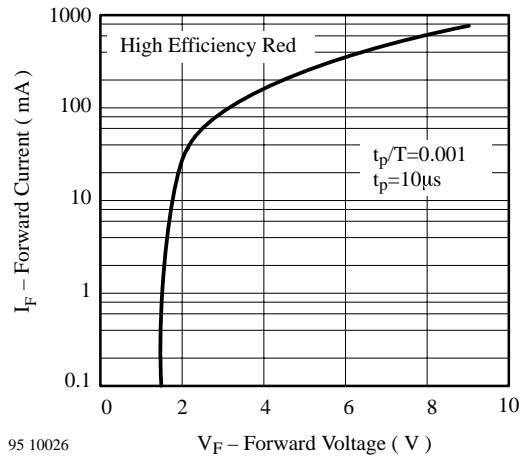

Figure 5 Forward Current vs. Forward Voltage

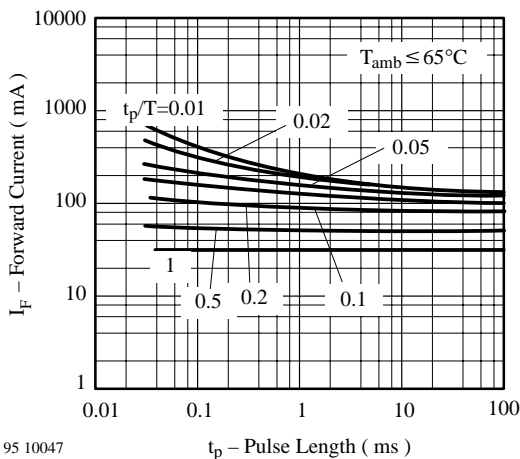

Figure 3 Forward Current vs. Pulse Length

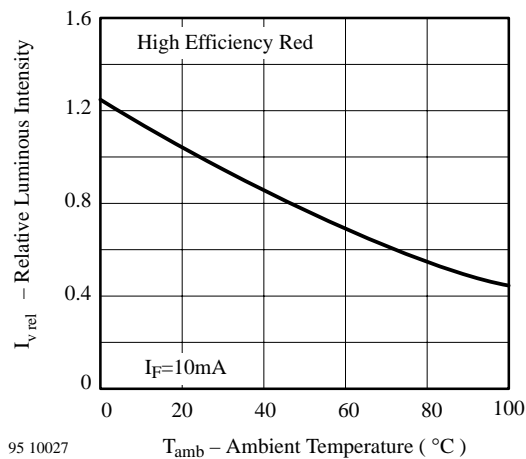

Figure 6 Rel. Luminous Intensity vs. Ambient Temperature

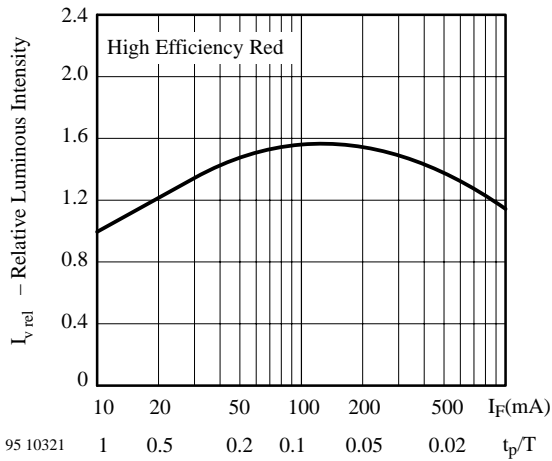

Figure 7 Rel. Lumin. Intensity vs. Forw. Current/Duty Cycle

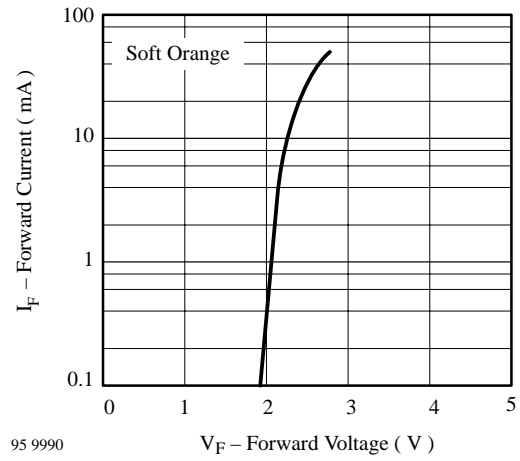

Figure 10 Forward Current vs. Forward Voltage

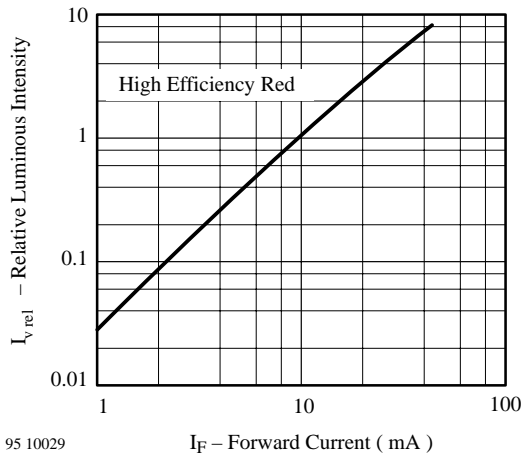

Figure 8 Relative Luminous Intensity vs. Forward Current

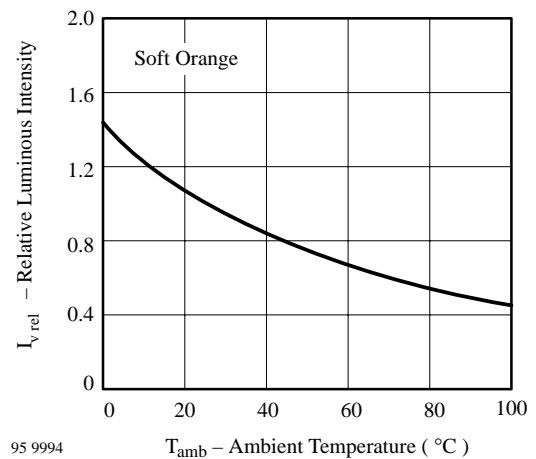

Figure 11 Rel. Luminous Intensity vs. Ambient Temperature

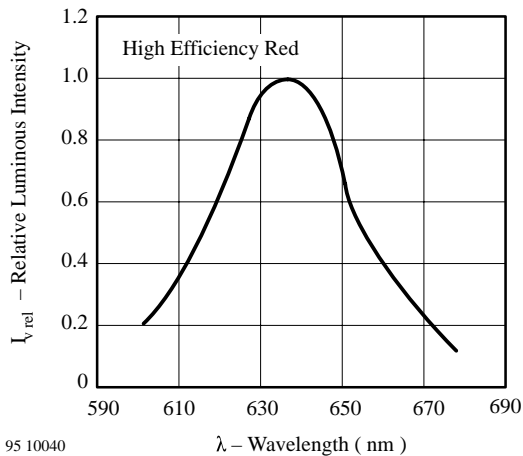

Figure 9 Relative Luminous Intensity vs. Wavelength

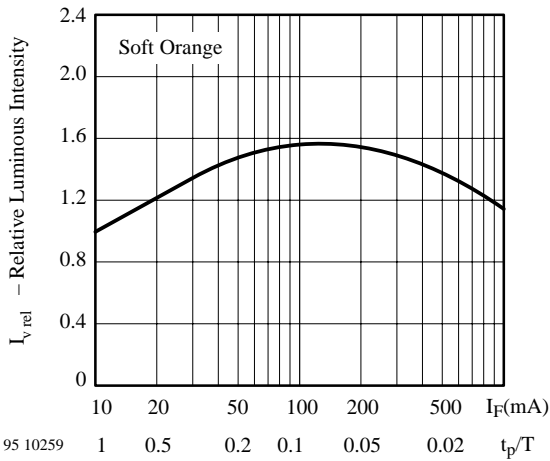

Figure 12 Rel. Lumin. Intensity vs. Forw. Current/Duty Cycle

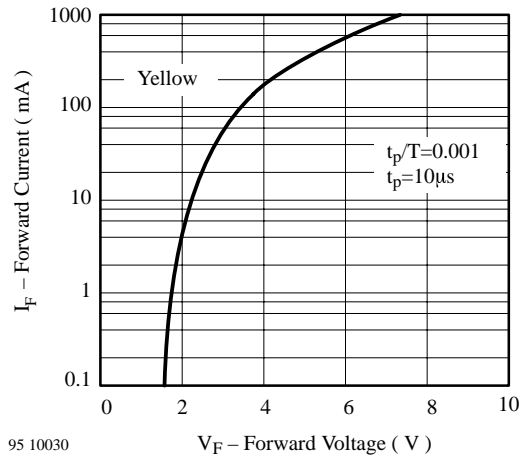

Figure 15 Rel. Luminous Intensity vs. Ambient Temperature

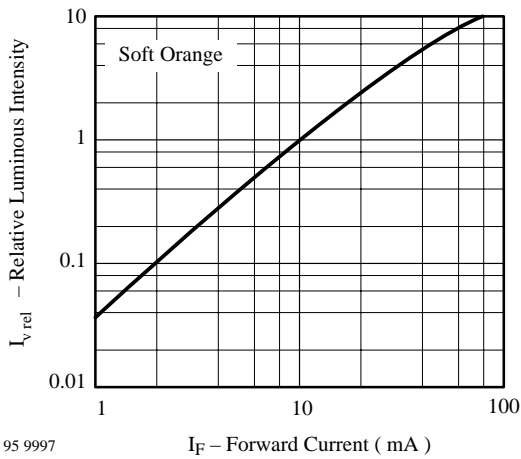

Figure 13 Relative Luminous Intensity vs. Forward Current

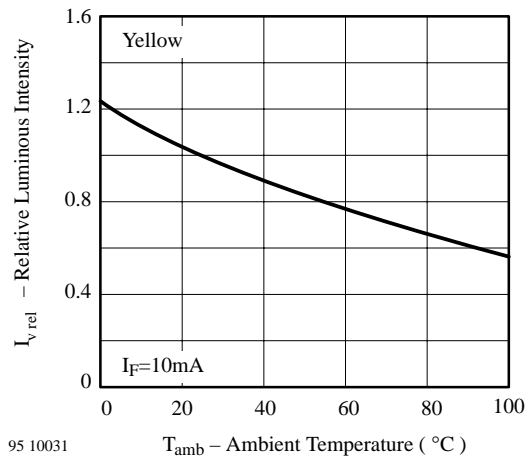

Figure 16 Rel. Luminous Intensity vs. Ambient Temperature

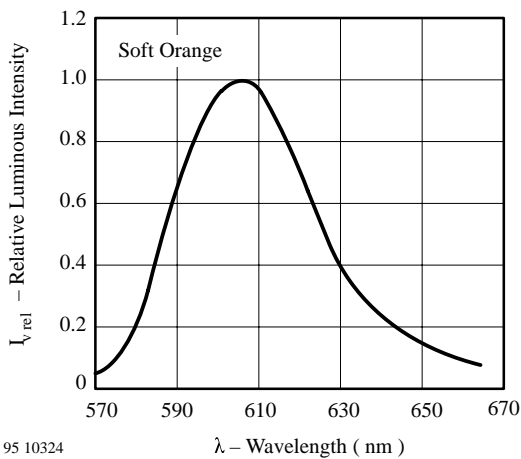

Figure 14 Relative Luminous Intensity vs. Wavelength

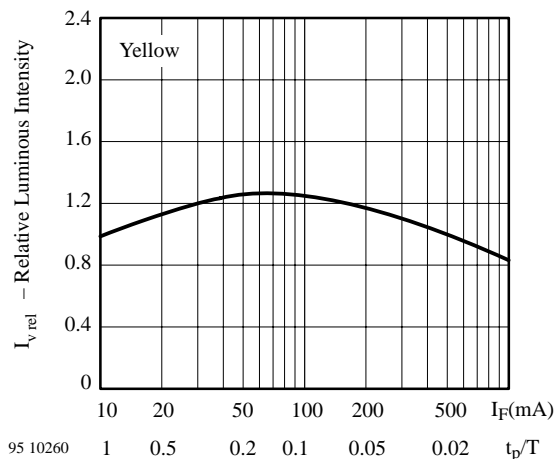
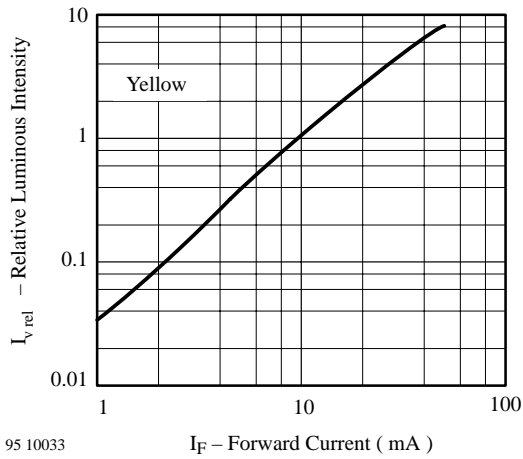
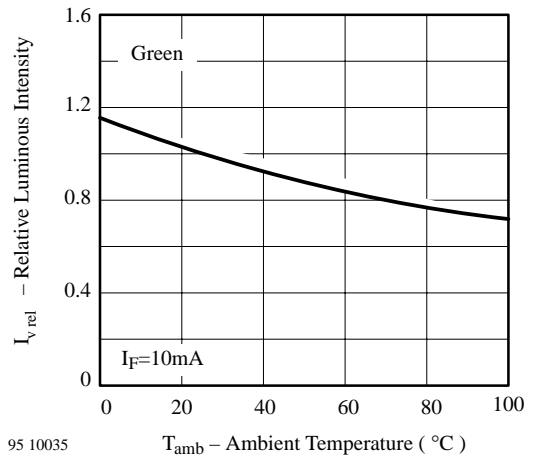

Figure 17 Rel. Lumin. Intensity vs. Forw. Current/Duty Cycle



95 10033
Figure 18 Relative Luminous Intensity vs. Forward Current



95 10035
Figure 21 Rel. Luminous Intensity vs. Ambient Temperature

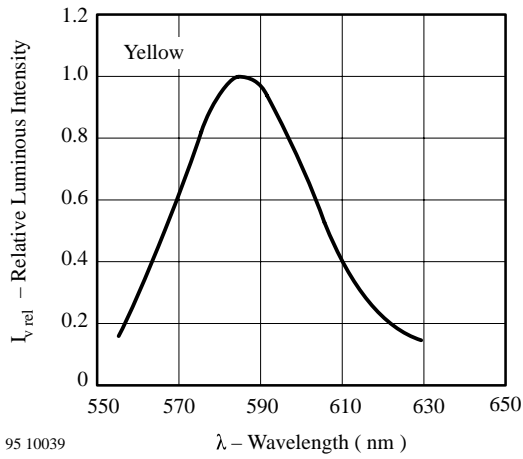

95 10039
Figure 19 Relative Luminous Intensity vs. Wavelength

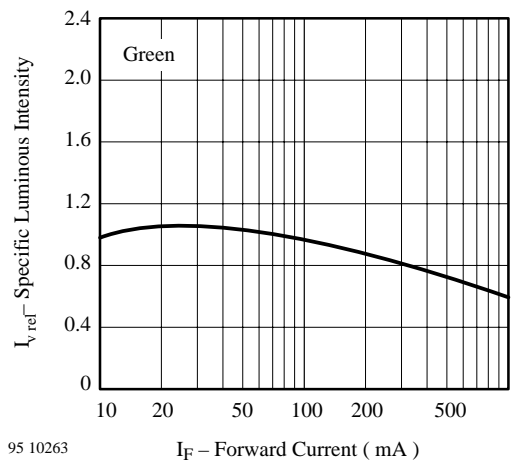

95 10263
Figure 22 Specific Luminous Intensity vs. Forward Current

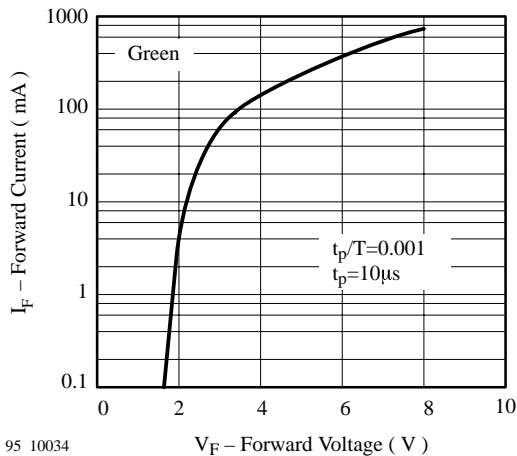

95 10034
Figure 20 Forward Current vs. Forward Voltage

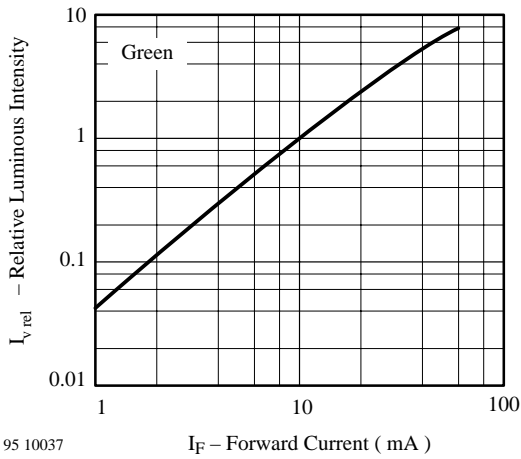

Figure 23 Relative Luminous Intensity vs. Forward Current

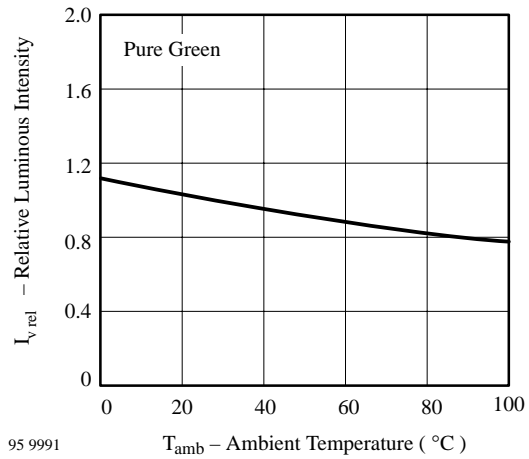

Figure 26 Rel. Luminous Intensity vs. Ambient Temperature

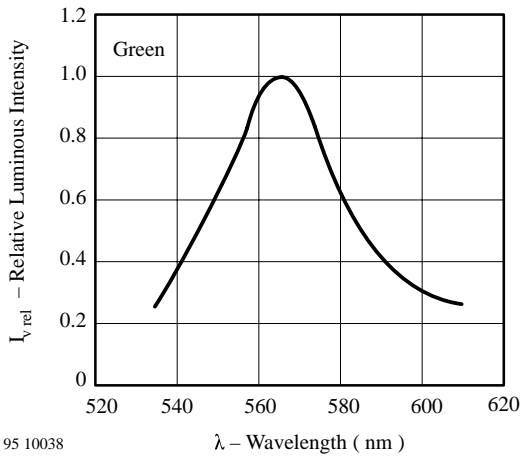

Figure 24 Relative Luminous Intensity vs. Wavelength

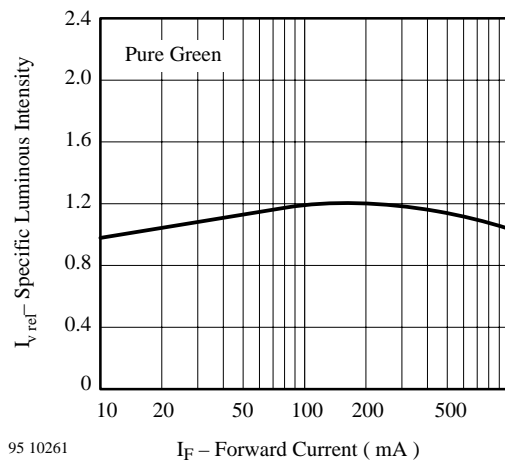

Figure 27 Specific Luminous Intensity vs. Forward Current

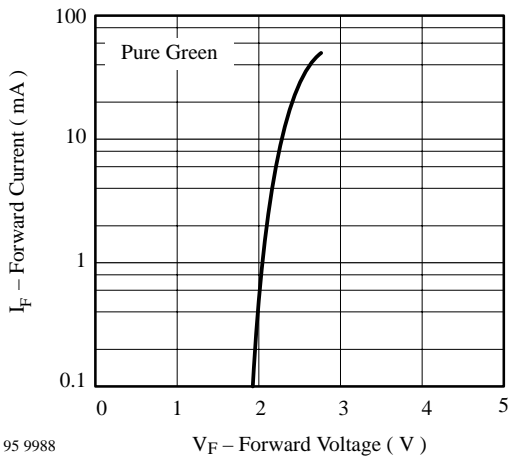

Figure 25 Forward Current vs. Forward Voltage

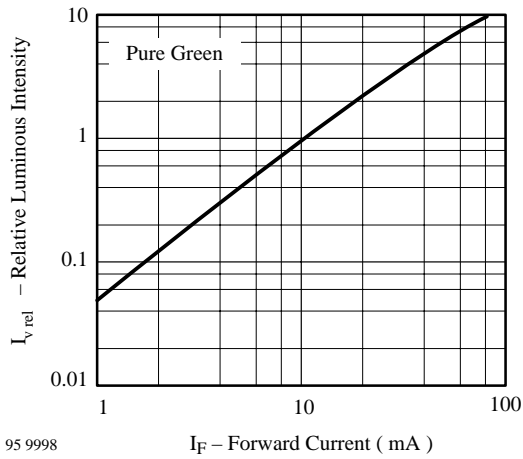

Figure 28 Relative Luminous Intensity vs. Forward Current

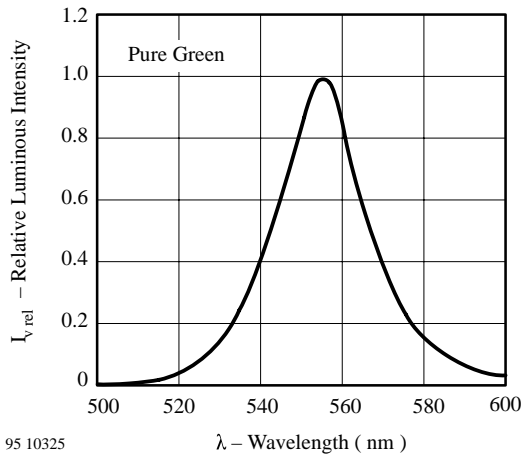
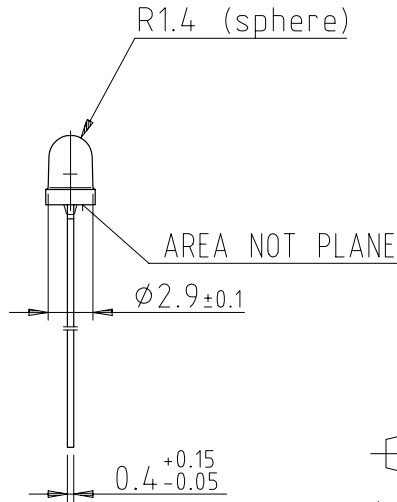
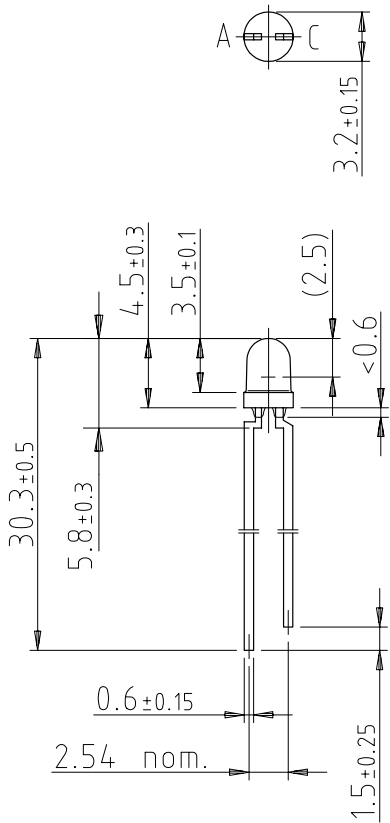

Figure 29 Relative Luminous Intensity vs. Wavelength

Dimensions in mm



95 10913

technical drawings
according to DIN
specifications



Ozone Depleting Substances Policy Statement

It is the policy of **Vishay Semiconductor GmbH** to

1. Meet all present and future national and international statutory requirements.
2. Regularly and continuously improve the performance of our products, processes, distribution and operating systems with respect to their impact on the health and safety of our employees and the public, as well as their impact on the environment.

It is particular concern to control or eliminate releases of those substances into the atmosphere which are known as ozone depleting substances (ODSs).

The Montreal Protocol (1987) and its London Amendments (1990) intend to severely restrict the use of ODSs and forbid their use within the next ten years. Various national and international initiatives are pressing for an earlier ban on these substances.

Vishay Semiconductor GmbH has been able to use its policy of continuous improvements to eliminate the use of ODSs listed in the following documents.

1. Annex A, B and list of transitional substances of the Montreal Protocol and the London Amendments respectively
2. Class I and II ozone depleting substances in the Clean Air Act Amendments of 1990 by the Environmental Protection Agency (EPA) in the USA
3. Council Decision 88/540/EEC and 91/690/EEC Annex A, B and C (transitional substances) respectively.

Vishay Semiconductor GmbH can certify that our semiconductors are not manufactured with ozone depleting substances and do not contain such substances.

We reserve the right to make changes to improve technical design and may do so without further notice.

Parameters can vary in different applications. All operating parameters must be validated for each customer application by the customer. Should the buyer use Vishay-Telefunken products for any unintended or unauthorized application, the buyer shall indemnify Vishay-Telefunken against all claims, costs, damages, and expenses, arising out of, directly or indirectly, any claim of personal damage, injury or death associated with such unintended or unauthorized use.

Vishay Semiconductor GmbH, P.O.B. 3535, D-74025 Heilbronn, Germany
Telephone: 49 (0)7131 67 2831, Fax number: 49 (0)7131 67 2423