

Product Data Sheet **9293510726**  
VWCE119PJGNS  
4314 N/2H3PU

**ebmpapst**

engineering a better life



4314 N/2H3PU

INDEX

**1 General ..... 3**

**2 Mechanics ..... 3**

2.1 General ..... 3

2.2 Connections ..... 3

**3 Operating Data ..... 4**

3.1 Electrical Interface - Input ..... 4

3.2 Electrical Operating Data ..... 5

3.3 Electrical Interface - Output ..... 6

3.4 Electrical Features ..... 7

3.5 Aerodynamics ..... 8

3.6 Sound Data ..... 9

**4 Environment ..... 9**

4.1 General ..... 9

4.2 Climatic Requirements ..... 10

4.3 Mechanical Requirements ..... 11

4.4 EMC ..... 11

**5 Safety ..... 13**

5.1 Electrical Safety ..... 13

5.2 Approval Tests ..... 13

**6 Reliability ..... 13**

6.1 General ..... 13

1 General

Fan type	Axial	
Rotating direction looking at rotor	Clockwise	
Airflow direction	Air outlet over struts	
Bearing system	Ball bearing	
Mounting position - shaft	Any	

2 Mechanics

2.1 General

Width	119,0 mm	
Height	119,0 mm	
Depth	32 mm	
Mass	0,26 kg	
Housing material	Plastic	
Impeller material	Plastic	
Max. torque when mounted across both mounting flanges	Wire outlet corner: 80 Ncm Remaining corners: 80 Ncm	
Screw size	ISO 4762 - M4 degreased, without an additional brace and without washer	
Rotor protrusion max.	0,4 mm	

2.2 Connections

Electrical connection	Wires	
Lead wire length	L = 310 mm	
Tolerance	+ - 10,0 mm	
Wire size (AWG)	24	
Insulation diameter	1,5 mm	

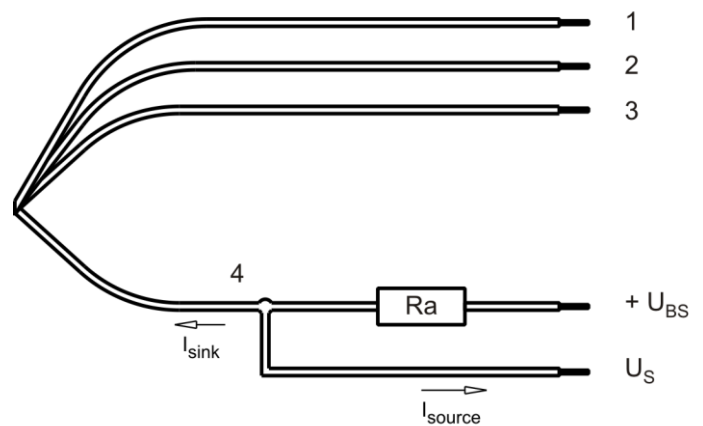

Wire	Color	Operation
1	red	+ UB
2	blue	- GND
3	violet	PWM
4	white	Tacho

The auxiliaries shown on the schematic diagram (which are required for the intended use) are not part of our delivery.

3 Operating Data

3.1 Electrical Interface - Input

Control input	PWM
---------------	-----

Features

Input type	Open collector	
PWM - Frequency		1 kHz - 30 kHz typical: 25 kHz
Max. voltage for logic "Low"		0,2 V
Maximum source current	short circuit current	$\leq 1$ mA
Typical time until warm restart	After shutdown by PWM	$\leq 9$ s

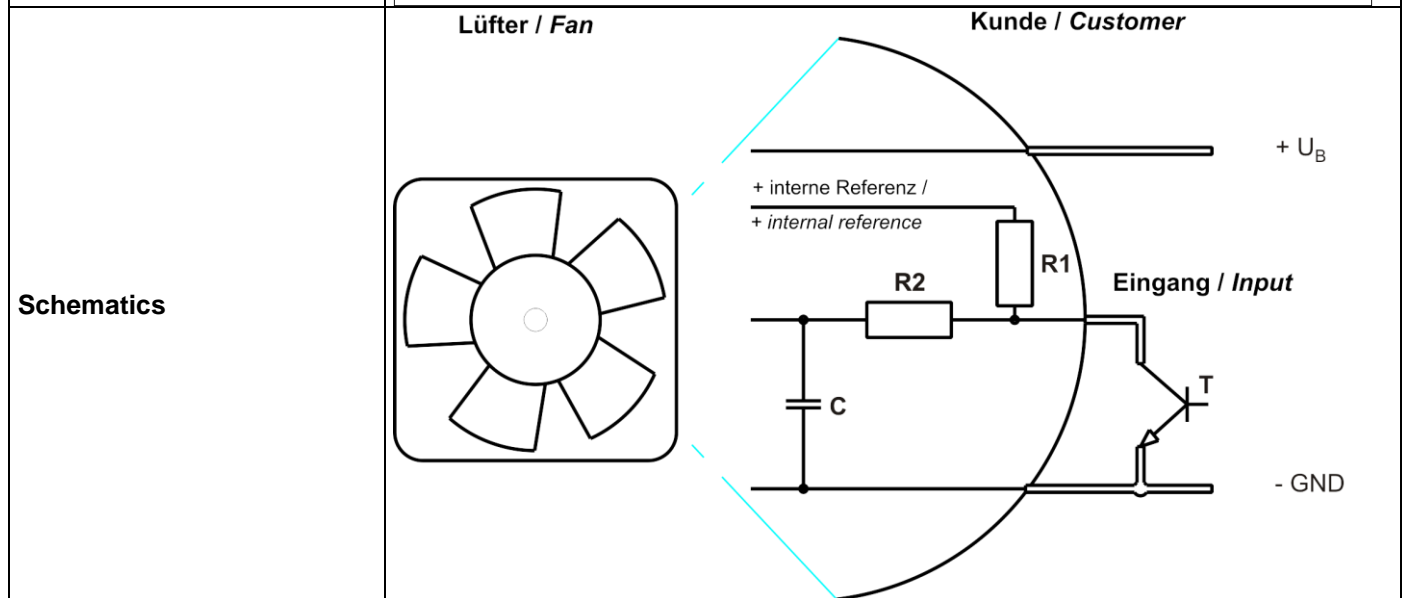
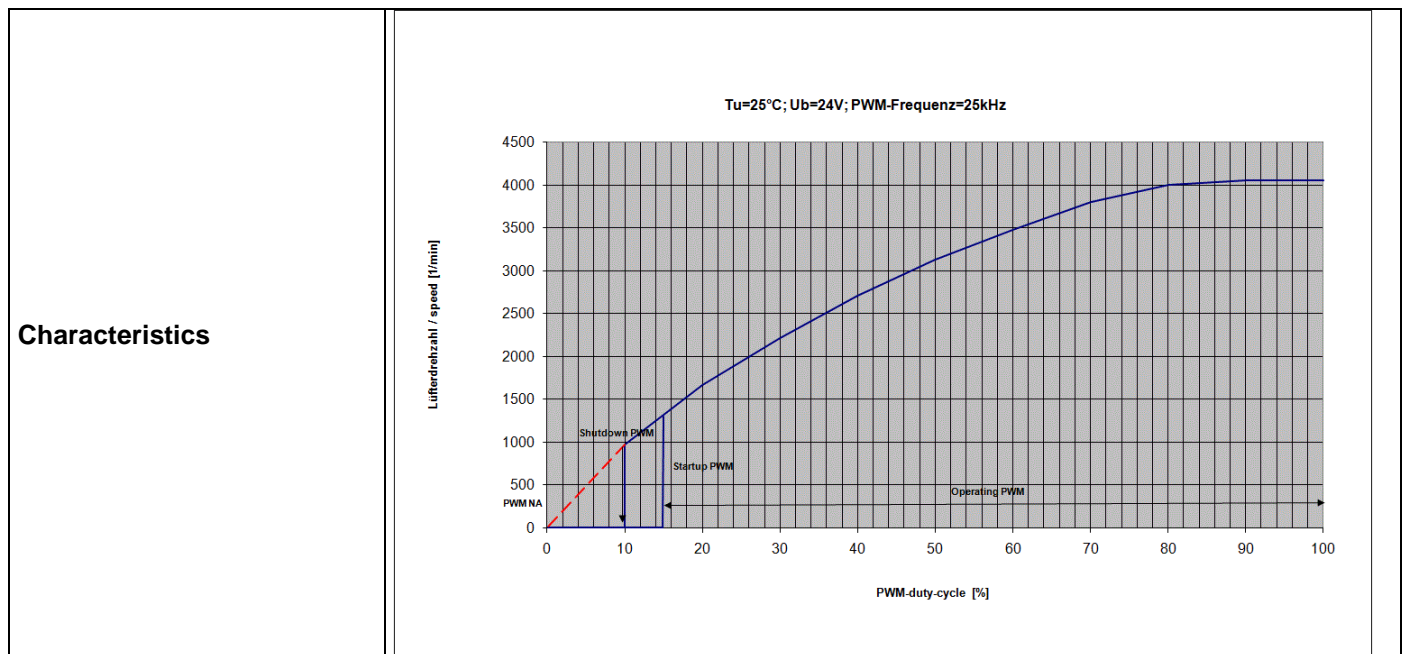

### 3.2 Electrical Operating Data

Measurement conditions: Normal air density = 1,2 kg/m<sup>3</sup>; Temperature 23°C +/- 3°C; Motor axis horizontal; warm-up time before measuring 5 minutes (unless otherwise specified). In the intake and outlet area should not be any solid obstruction within 0,5 m.

$\Delta p = 0$ : corresp. to free air flow (see chapter aerodynamics)

I: corresp. to arithm. mean current value

Name	Condition
PWM 0001	PWM: 100 %; f: 25 kHz

Features	Condition	Symbol	Values		
Voltage range		U	14 V		26,4 V
Nominal voltage		U <sub>N</sub>		24 V	
Power consumption	$\Delta p = 0$	P	3,5 W	11 W	13,2 W
Tolerance	PWM 0010		+/- 17,5 %	+/- 12,5 %	+/- 15 %
Current consumption	$\Delta p = 0$	I	250 mA	460 mA	500 mA
Tolerance	PWM 0010		+/- 17,5 %	+/- 12,5 %	+/- 15 %
Speed	$\Delta p = 0$	n	2.700 1/min	4.050 1/min	4.260 1/min
Tolerance	PWM 0010		+/- 12,5 %	+/- 7,5 %	+/- 10 %
Starting current consumption				750 mA	

3.3 Electrical Interface - Output

Tacho type	/2 (open collector)
------------	---------------------

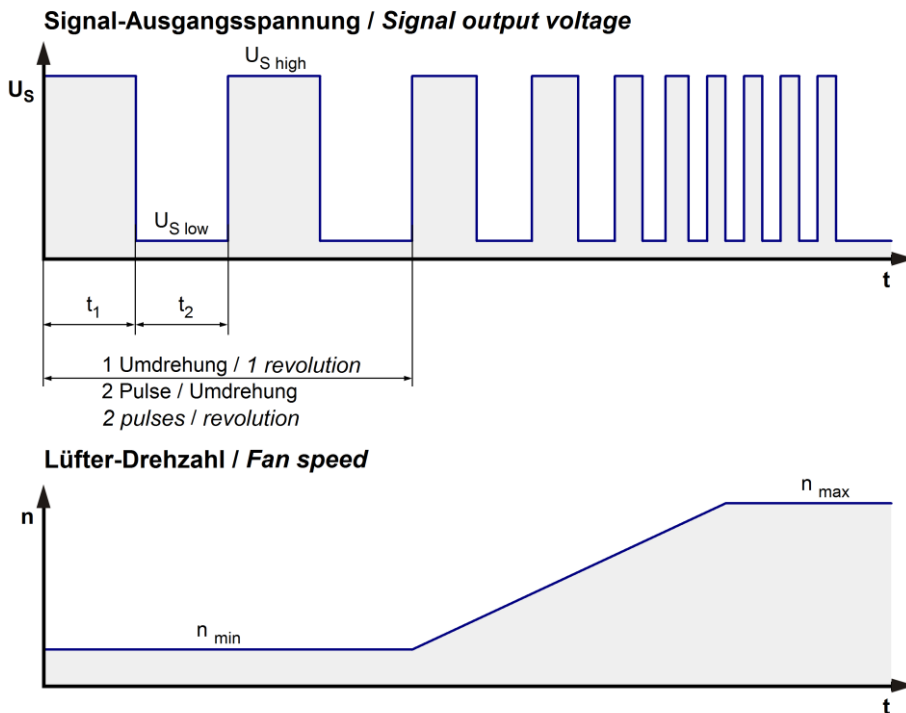

$$R_a = \frac{U_{BS} - U_{S\ low}}{I_{sink}}$$

Lüfter / Fan      Kunde / Customer

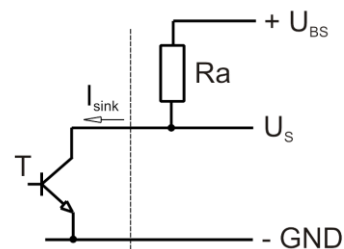

Features	Note	Values
Tacho operating voltage	$U_{BS}$	$\leq 60\ V$
Tacho signal Low	$U_{S\ low}$	$\leq 0,4\ V$
Tacho signal High	$U_{S\ high}$	$60\ V$
Maximum sink current	$I_{sink}$	$\leq 4\ mA$
External resistor	All voltages measured to GND.	
Tacho frequency	$(2 \times n) / 60$	
Tacho isolated from motor	No	
Slew rate		$\Rightarrow 0,5\ V/\mu s$

n = revolutions per minute (1/min)

3.4 Electrical Features

Electronic function	None	
Reversed polarity protection	Rectifying diode	
Max. residual current at $U_N$	$I_F < 100 \mu A$	
Locked rotor protection	Auto restart	
Locked rotor current at $U_N$	$I_{block}$ approx. 1.000 mA	
Clock signal at locked rotor	$t_3 / t_4$ typical: 1 s / 9 s	

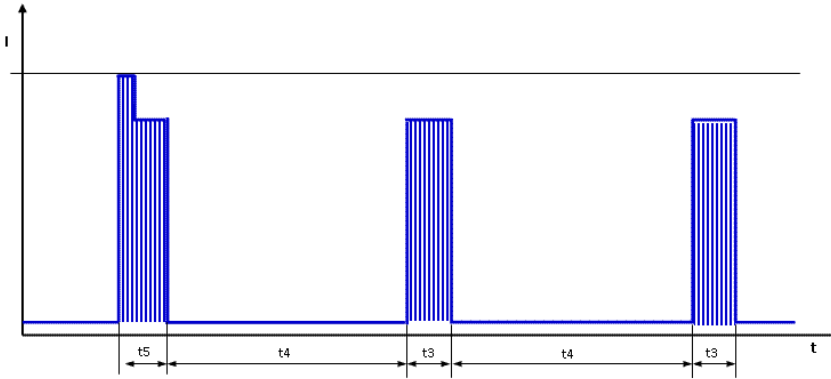

First pulse  $t_5$  typical 1,6s (1,3 .. 1,9s) followed by  $t_4$ . Afterwards cyclical  $t_3/t_4$ .

### 3.5 Aerodynamics

Measurement conditions: Measured with a double chamber intake rig acc. to DIN EN ISO 5801. Normal air density = 1,2 kg/m<sup>3</sup>; Temperature 23°C +/- 3°C; In the intake and outlet area should not be any solid obstruction within 0,5 m. Motor shaft horizontal.

The information is only valid under the specified test conditions and may be changed by the installation conditions. If there are deviations from the standard test conditions, the characteristic values must be checked under the installed conditions. Power consumption of the fan motor when operating at normal voltage is shown. Depending on the operating conditions of the application, the power input may be higher.

a.) Operation condition:

4.050 1/min at free air flow	PWM 100 %; f: 25 kHz		
------------------------------	----------------------	--	--

Max. free-air flow ( $\Delta p = 0 / \dot{V} = \text{max.}$ )	285 m <sup>3</sup> /h	
Max. static pressure ( $\Delta p = \text{max.} / \dot{V} = 0$ )	146 Pa	

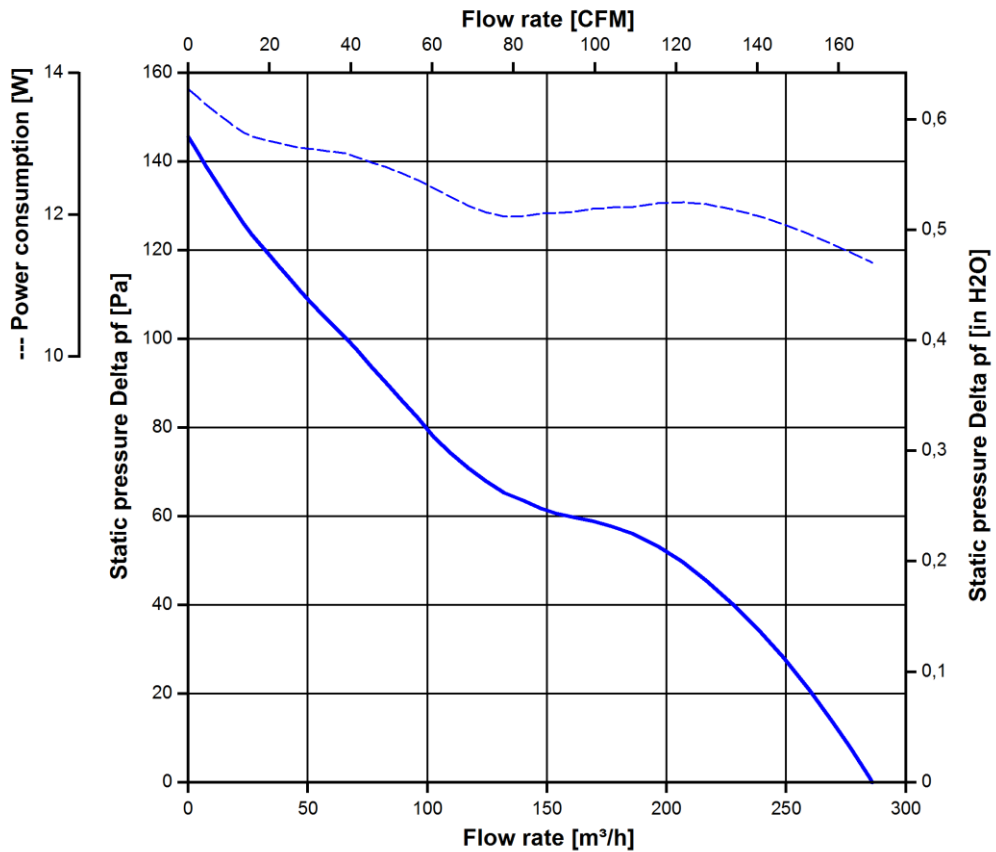



**3.6 Sound Data**

Measurement conditions: Sound pressure level: 1 meter distance between microphone and the air intake.  
 Sound power level: Acc. to DIN 45635 part 38 (ISO 10302)  
 Measured in a semianechoic chamber with a background noise level of  $L_p(A) < 5 \text{ dB(A)}$   
 For further measurement conditions see chapter aerodynamics.

a.) Operation condition:

4.050 1/min at free air flow	PWM 100 %; f: 25 kHz		
------------------------------	----------------------	--	--

Optimal operating point	208 m <sup>3</sup> /h @ 49 Pa		
Sound power level at the optimal operating point	6,6 bel(A)		
Sound pressure level at free air flow, measured in rubber bands	55 dB(A)		

**4 Environment**

**4.1 General**

Min. permitted ambient temperature TU min.	-20 °C		
Max. permitted ambient temperature TU max.	75 °C		
Min. permitted storage temperature TL min.	-40 °C		
Max. permitted storage temperature TL max.	80 °C		

## 4.2 Climatic Requirements

IP-protection type (certified)	IP 68 (for fan only, not for connector if applicable) **)	
Humidity requirements	humid temperature, cyclic; according to DIN EN 60068-2-38, 10 cycle and condensation water check; according to DIN EN ISO 6270-2, 14 days	
Salt fog requirements	Salt fog, cyclic, in operation; according to DIN EN 60068-2-52; 10 cycles	

Permitted application area:

The product is for the use in open and unsheltered areas. Direct exposure to water as well as saline ambient conditions are allowed provided that this does not prevent the normal operation.

Pollution degree 4 (according DIN EN 60664-1)

It occurs permanent conductivity caused by conductive dust, rain or moisture.

\*\*) The specification of the IP protection refers to the conditions mentioned in certification of the fan. The above mentioned short description of the protection scope is not final. For detailed information of the respective protection scope and definitions, see certification as well as DIN EN 60529 (protection by housings) and ISO 20653 (for vehicles) with the letter K.

### **Short description of the IP-protection type:**

Solid particle Protection: Dust tight.

Protection against deliberate contact: Protected against contact to hazardous parts with a wire.

Protection against water: The fan test according to IP68 (Based on IEC 60529), is conducted in non-operating mode. The fan is tested by a complete immersion in water for a period of 2h at a water-level of 1,2m. Electrical connections are not immersed since they are customer specific.

4.3 Mechanical Requirements

severity level	Vibration (sinusoidal)	
0,5 G	Vibration (sinusoidal) in use IEC 60068-2-6 Displacement / frequency range Acceleration / frequency range Sweep rate Sweep cycles Duration Axes of vibration	Vibration (sinusoidal) 0,035 mm / 10-60, 60-10 Hz 0,5 G / 60-500-60 Hz 1 Oct./min 10 2 hrs. 3

severity level	stationary use		
1	storage / transportation	Random vibration not in use IEC 60068-2-64 Frequency range / ASD  G <sub>RMS</sub> Axes of vibration Test duration	Random vibration 5 - 20 Hz : 1,0 m <sup>2</sup> / s <sup>3</sup> 20 - 500 Hz : - 3 dB / Oct 0,91 G 3 3 x 5 h
	storage / transportation	Bump not in use IEC 60068-2-29 Shock spectrum Acceleration Duration Number of bumps (+X, -X, -Y, +Y, -Z, +Z) Total bumps	Bump half sine 18 G 6 ms 100 in each direction 600
	stationary use	Random vibration in use IEC 60068-2-64 Frequency range / ASD  G <sub>RMS</sub> Axes of vibration Test duration	Random vibration 5 - 20 Hz : 2,0 m <sup>2</sup> / s <sup>3</sup> 20- 150 Hz : - 3 dB / Oct 0,83 G 3 3 x 5 h
	stationary use	Bump in use IEC 60068-2-29 Shock spectrum Acceleration Duration Number of bumps (+X, -X, -Y, +Y, -Z, +Z) Total bumps	Bump half sine 5 G 11 ms 100 in each direction 600

4.4 EMC

<b>Kind</b>	<b>Radiated Emission; 30 MHz - 1000 MHz</b>
According	DIN EN 55032:2016-02
Check accuracy / Limit	Class B
Result	Below limit Class B

<b>Kind</b>	<b>Electrical Fast Transient / Burst Immunity Test</b>
According	DIN EN 61000-4-4:2005-07
Check accuracy / Limit	+/- 2 kV on Power Lines; Coupling: POS, NEG, {PE}, ALL, 5 kHz and 100 kHz; 1 min
Result	A: The monitored function operates as designed during and after exposure to a disturbance.

**5 Safety****5.1 Electrical Safety**

Dielectric strength DIN EN 62368 and DIN EN 60335 A.) Type test Measuring conditions: After 48h of storage at 95% R.H. and 25°C. No arcing or breakdown is allowed! All connections together to ground. B.) Routine test Measuring conditions: At indoor climate. No arcing or breakdown is allowed! All connections together to ground.	500 VAC / 1 Min.  Not applicable	
Isolation resistance Measuring conditions: After 48h of storage at 95% R.H. and 25°C measured with U=500 VDC for 1 min.	RI > 10 MOhm	
Clearance / creepage distance	1,0 mm / 1,2 mm	
Protection class	III	

**5.2 Approval Tests**

CE	EC Declaration of Conformity	Yes
EAC	Eurasian Conformity	Yes
UL	Underwriters Laboratories	Yes / UL507, Electric Fans E38324
VDE	Association for Electrical, Electronic and Information Technologies	Yes / Approval acc. to EN 62368 - Audio/video, information and communication technology equipment
CSA	Canadian Standards Association	Yes / C22.2 No. 113 Fans and Ventilators
CCC	China Compulsory Certification	Not applicable

**6 Reliability****6.1 General**

Life expectancy L10 at TU = 40 °C	60.000 h	
Life expectancy L10 at TU max.	25.000 h	
Life expectancy L10 acc. to IPC 9591 at TU = 40 °C	102.500 h	

The reproduction, distribution and utilization of this document as well as the communication of its contents to others without express authorization is prohibited. Offenders will be held liable for the payment of damages. All rights reserved in the event of a patent, utility model or design. Refer to protection notice ISO 18016.  
 Note: in case of multilingual information in this document and in the applicable documents referred to in this document, only the English version shall be authoritative and legally binding in the event of contradictions in content.

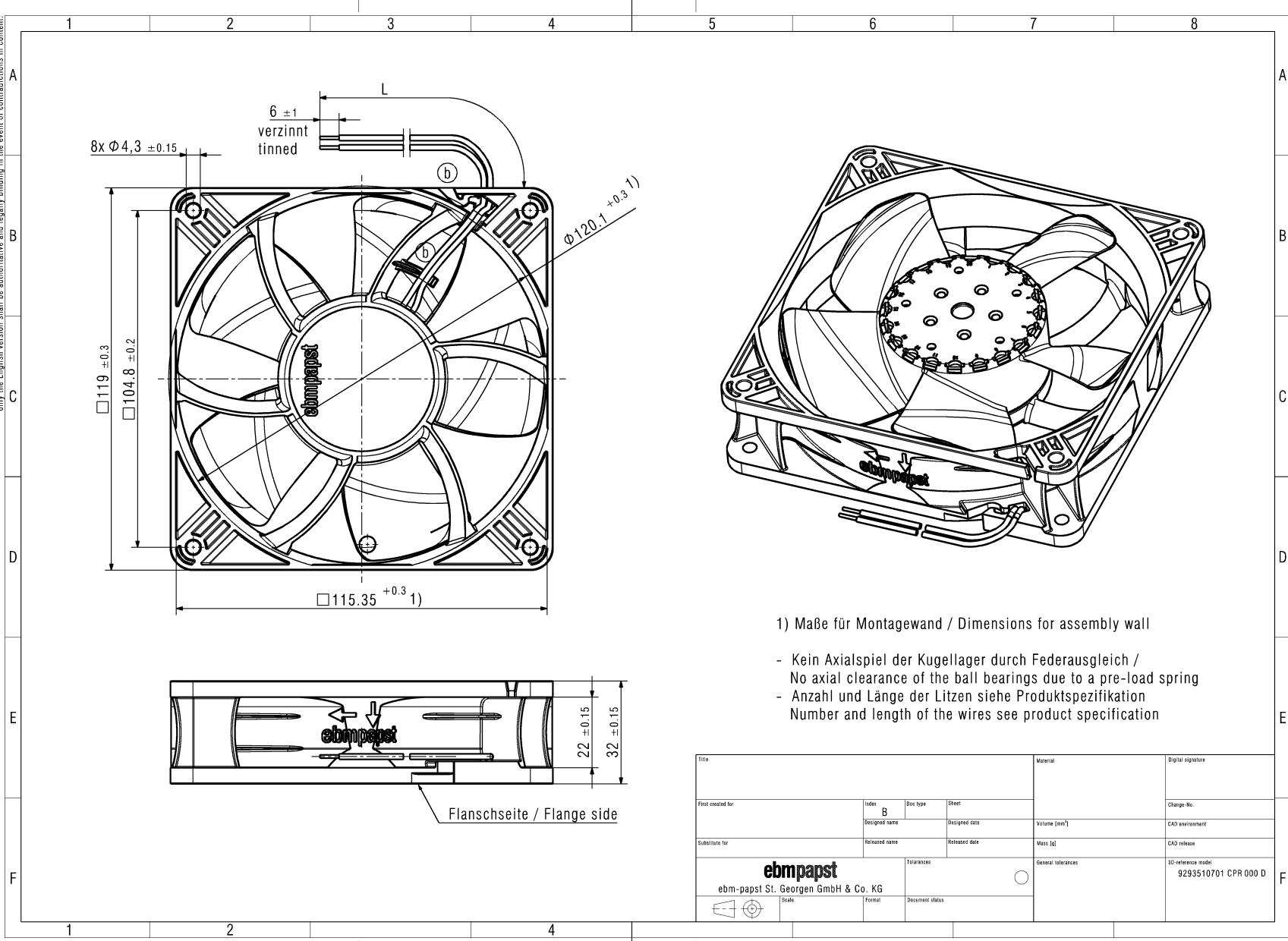

1) Maße für Montagewand / Dimensions for assembly wall

- Kein Axialspiel der Kugellager durch Federausgleich / No axial clearance of the ball bearings due to a pre-load spring
- Anzahl und Länge der Litzen siehe Produktspezifikation  
Number and length of the wires see product specification

Title				Material		Digital signature	
First created for		Index	Doc type	Sheet		Change-No.	
		B				CAD environment	
Substitute for		Designed name	Designed date		Volume (mm <sup>3</sup> )		CAD release
		Released name	Released date		Mass (g)		
<b>ebmpapst</b>				Tolerances		General tolerances	
ebm-papst St. Georgen GmbH & Co. KG						3D-reference model 9293510701 CPR 000 D	
Scale		Format		Document status			