

## Customer Part:



### Description

- Standard 2 x 1.6mm crystal oscillator in a hermetically sealed ceramic package with a seam sealed metal lid
- Model IQXO-542
- Model Issue number 4

### Frequency Parameters

- Frequency 24.0MHz
- Frequency Stability  $\pm 25.00\text{ppm}$
- Operating Temperature Range  $-20.00$  to  $70.00^\circ\text{C}$
- Ageing  $\pm 5\text{ppm}$  max per year @  $25^\circ\text{C}$

### Electrical Parameters

- Supply Voltage  $1.8\text{V} \pm 10\%$
- Current Draw  $5.000\text{mA}$

### Output Details

- Output Compatibility CMOS
- Drive Capability  $15\text{pF}$  max
- Rise and Fall Time  $5.0\text{ns}$  max
- Duty Cycle  $45/55\%$
- Start up Time:  $10\text{ms}$  max.  
 $1.1\text{ms}$  typ to 90% of final amplitude (Under ideal conditions @  $25^\circ\text{C}$ )

### Output Control

- Standby Operation: Logic '1' ( $\geq 70\%V_s$ ) to pad 1 enables oscillator output  
Logic '0' ( $\leq 30\%V_s$ ) to pad 1 disables oscillator output; when disabled the oscillator output goes to the high impedance state  
No connection to pad 1 enables oscillator output
- Standby Current:  $10\mu\text{A}$  max,  $0.6\mu\text{A}$  typ @  $25^\circ\text{C}$

### Output Levels

- Output High (VoH): 90% of  $V_s$  min  
Output Low (VoL): 10% of  $V_s$  max

### Environmental Parameters

- Impact: Weight of 10g dropped to centre of part from a height of 6mm
- Vibration: IEC 60068-2-6: 1.5mm amplitude, 10Hz-55Hz, 1min in 3 mutually perpendicular planes, duration 2hrs each plane (total 6hrs)
- Storage Temperature Range:  $-40$  to  $85^\circ\text{C}$
- RoHS Terminations
- RoHS Reflow Temp  $250^\circ\text{C}$  max for 10s max

### Compliance

- RoHS Status (2015/863/EU) Compliant
- REACH Status Compliant
- MSL Rating (JDEC-STD-033): Not Applicable

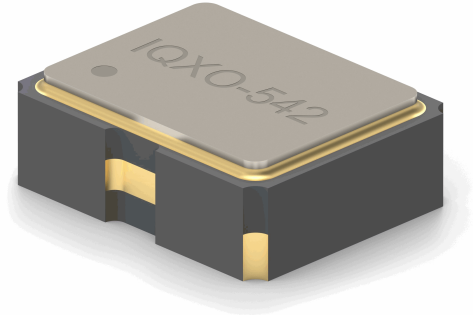

### Outline (mm)

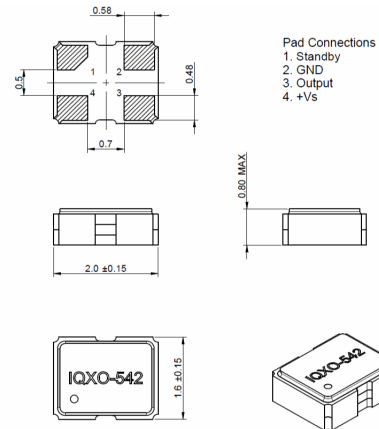

### Test Circuit

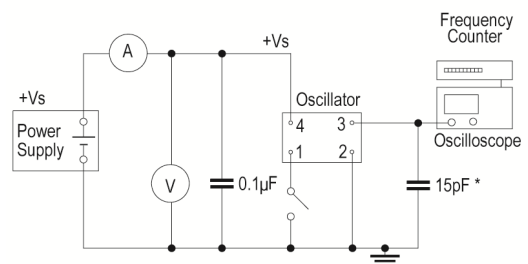

\* Inclusive of jigging and equipment capacitance

### Sales Office Contact Details:

UK: +44 (0)1460 270200

USA: +1.760 668 8935

Email: [info@iqdfrequencyproducts.com](mailto:info@iqdfrequencyproducts.com)

Web: [www.iqdfrequencyproducts.com](http://www.iqdfrequencyproducts.com)

**Customer Part:**

**Packaging Details**

- Tape & reel in accordance with EIA-481  
Quantities below the standard reel size to be supplied on cut tape.  
Standard Quantity: 3,000 Pieces

**Test Circuit**

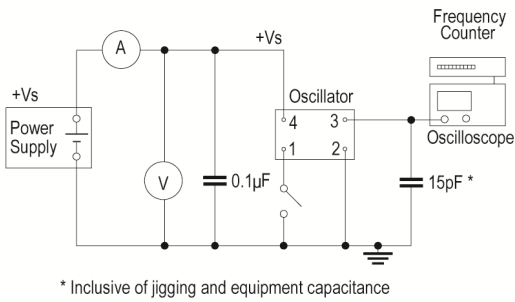

**Wave Form**

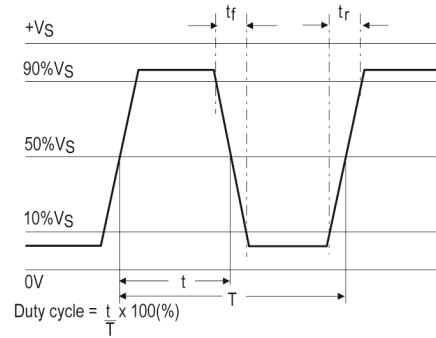

**Sales Office Contact Details:**

UK: +44 (0)1460 270200

USA: +1.760 668 8935

Email: [info@iqdfrequencyproducts.com](mailto:info@iqdfrequencyproducts.com)

Web: [www.iqdfrequencyproducts.com](http://www.iqdfrequencyproducts.com)