

ROCKER

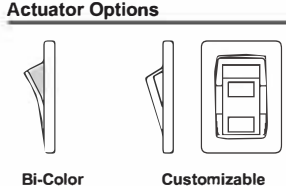
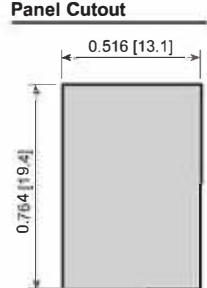
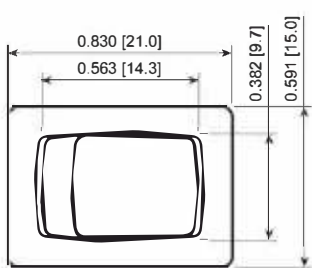

FEATURES:

- High Rating
- Snap in with Multiple terminal options
- Many Functions Available
- PVC Cap for Dust and Water Protection

SPECIFICATIONS:
RATING: RATING OPTION C:
16A 125VAC [cULus]

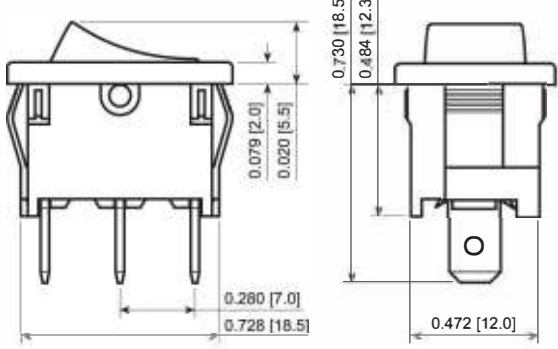

Rating Option 3:
11A 125VAC [cULus]
5.5A 250VAC [cULus]

Ratings of Illuminated Switches May Vary

TEMPERATURE: -20°C to 55°C
ELECTRICAL LIFE: 10,000 Cycles
CONTACT RESISTANCE: 30mΩ Max.
INSULATION RESISTANCE: 500MΩ Min. at 500VDC
DIELECTRIC STRENGTH: 1,000VAC for 1 Minute
INGRESS PROTECTION: IP54 with PVC Cap

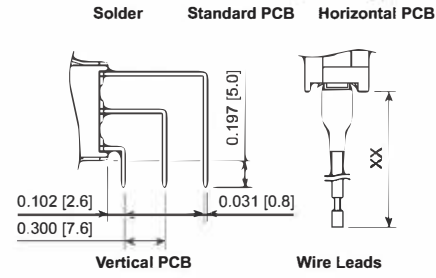

Water Protection Option

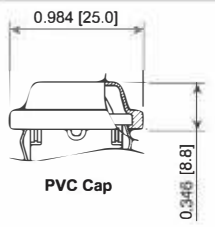

Illumination Options

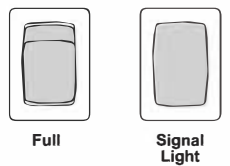

Dimensions of Illuminated Switches May Vary From Above

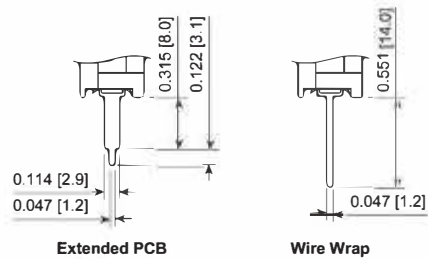

RA111C1A00



RA111C1021-116



RA111C1213

RA113C1100 ACC-P01

| Series | Terminal | Function | Rating | Body Color | Actuator Color | Marking Color | Marking Type | Lens Style | Lens Color | Lamp Voltage |
|-----------------------|--------------------------------|---|--|------------------------------------|---|---|--|-------------------|--|---|
| RA1 - Curved Actuator | 0 - Blank 1 - 4.8mm Tab (*) | 0 - Signal / Blank 1 - Off-On (*) 3 - On-On 4 - Off.(On) 5 - On-Off-On A - On-(Off) C - On-Off-(On) | 0 - Signal / Blank 3 - 11A 125V C - 16A 125V | 1 - Black 2 - White 4 - Grey | 0 - Illuminated 1 - Black 2 - White 4 - Grey 7 - Blue 8 - Green 9 - Red | 0 - None 1 - Black 2 - White 8 - Red | 0 - None 1 - I/O Vert. 2 - ON/OFF/ON Vert. 3 - ON/OFF Vert. 4 - ON/OFF Horiz. 9 - I/O/II Horiz. S - I/O/II Vert. R - I/O Horiz. | 1 - Full / Signal | 0 - Clear 1 - Red 2 - Amber 3 - Green 4 - Blue 5 - Yellow | 3 - 6V 4 - 12V 6 - 125V 7 - 250V |

Notes:
Not All Combinations are Available, Please Check with Sales.
* = Options Available with Illuminated Switches

EXAMPLE PART NUMBERS:

| | |
|----------------|---|
| RA11131100 | 1P Off-On Black Body/Actuator, No Marking |
| RA11131121 | 1P Off-On Black Body/Actuator, I/O Vert. |
| RA111C1100 | 1P Off-On Black Body/Actuator, No Marking |
| RA111C1121 | 1P Off-On Black Body/Actuator, I/O Vert. |
| RA111C1021-116 | 1P Off-On Red Illum. Actuator, Black Body, I/O Vert. |
| RA11331100 | 1P On-On Black Body/Actuator, No Marking |
| RA11531100 | 1P On-Off-On Black Body/Actuator, No Marking |
| RA11531122 | 1P On-Off-On Black Body/Actuator, ON/OFF/ON Vert. |
| RA13131100 | 1P Off-On Black Body/Actuator, PCB Pins, No Marking |
| RA1H331100 | 1P On-On Black Body/Actuator, Right Angle PCB Pins |

Custom Colors and Markings Available Upon Request For Illuminated Switches Only

SPECIFICATIONS SUBJECT TO CHANGE WITHOUT NOTICE 2022