

800U SERIES PUSHBUTTON SWITCH

ANTI-VANDAL SWITCHES
DETECTOR SWITCHES
DIP SWITCHES
KEYLOCK SWITCHES
NAVIGATION SWITCHES
PUSHBUTTON SWITCHES
ROCKER SWITCHES
ROTARY SWITCHES
SLIDE SWITCHES
SNAP ACTION SWITCHES
TACTILE SWITCHES
TOGGLE SWITCHES
CAP OPTIONS

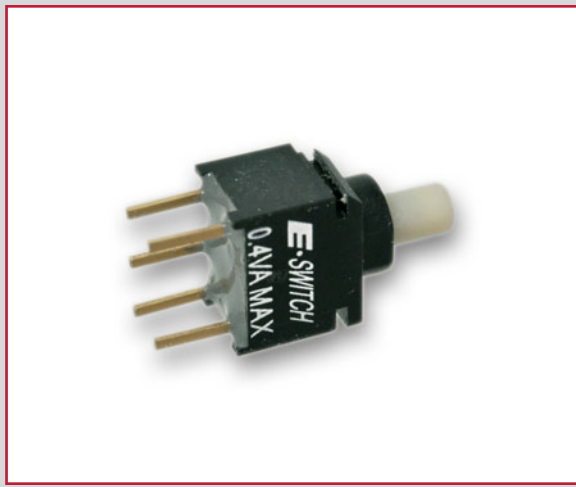

APPLICATIONS / MARKETS

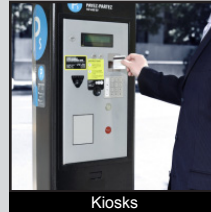
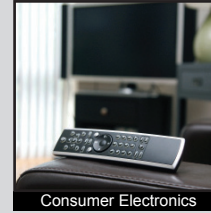
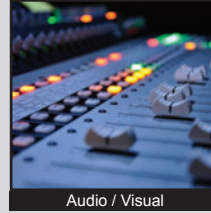

RoHS

SPECIFICATIONS

Electrical Rating: 0.4VA @ 20V Max (AC or DC)
Mechanical Life: 40,000 Cycles
Electrical Life: 6,000 Cycles
Contact Resistance: 100mΩ initial
Insulation Resistance: 500 MΩ Min.
Dielectric Strength: 500VAC
Operating/Storage Temperature: -30°C to 85°C
Travel: 1.0mm
Circuit Function: SPDT, DPDT
Actuation Force: 250 gf

FEATURES & BENEFITS

- Ultra-miniature in size
- IP67 rated
- Multiple termination options
- Multiple cap colors
- Single or double pole

PART NUMBER CONFIGURATOR

Series	Circuit	Function	Actuator	Bushing	Terminal	Contact Material	Seal	Cap	Cap Color
800U	SP - Single Pole DP - Double Pole	8 - ON - (ON)*	P1 - 3.30 High	A1 - 1.6 High	M2 - PC thru-hole M6 - Right Angle, PC thru-hole M7 - Vertical right angle, PC thru-hole	R - Gold	E - Epoxy	None R1 - 4.0 dia. round	None BLK - Black RED - Red WHT - White

CAP CONFIGURATOR*

Series	Cap Style	Cap Color
800U	R1	BLK - Black RED - Red WHT - White

* () denotes momentary

*You can order just the switch with or without the cap using the first ordering code above, or you can order the cap as a separate part number using the smaller ordering code directly above.

Specifications subject to change without notice



E-SWITCH®

www.e-switch.com

800.867.2717

2

800U SERIES PUSHBUTTON SWITCH

SPDT DIMENSIONS

M2 Termination

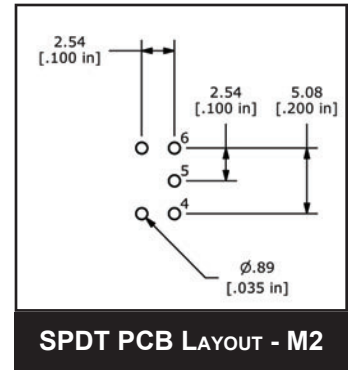
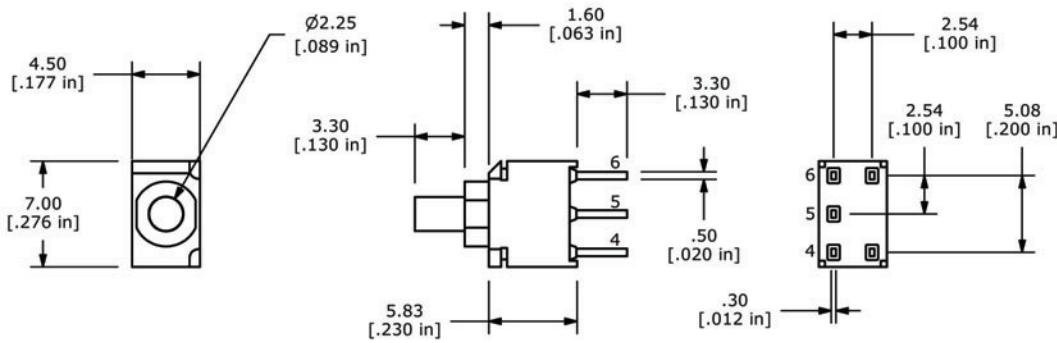

SPDT PCB LAYOUT - M2

M6 Termination

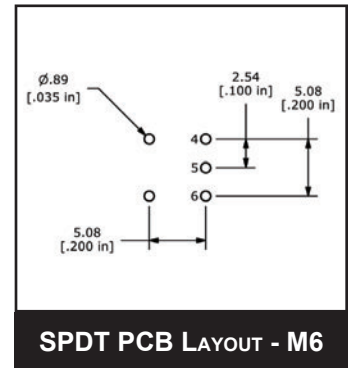
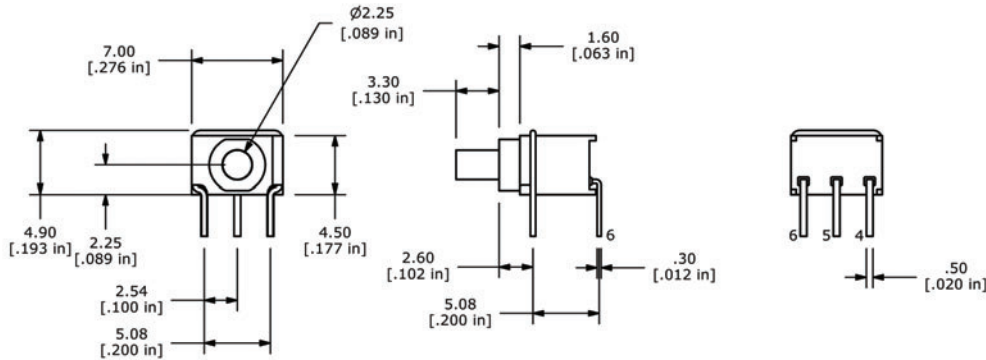

SPDT PCB LAYOUT - M6

M7 Termination

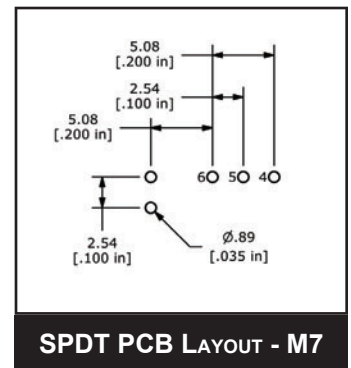
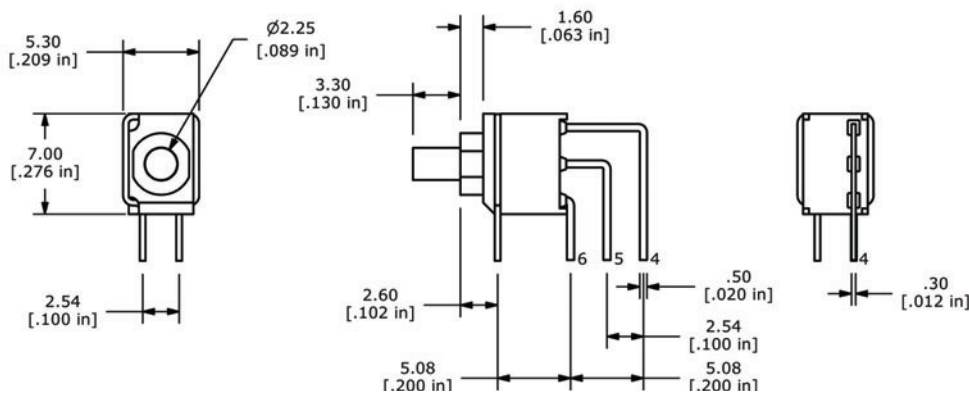

SPDT PCB LAYOUT - M7

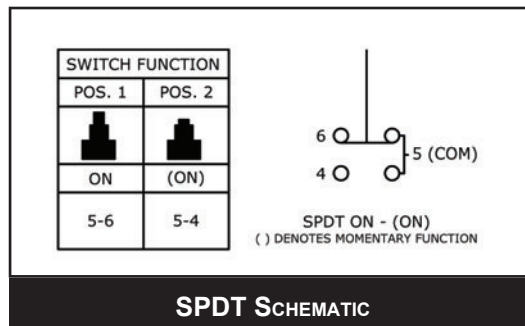

SPDT SCHEMATIC



ANTI-VANDAL SWITCHES
DETECTOR SWITCHES
DIP SWITCHES
KEYLOCK SWITCHES
NAVIGATION SWITCHES
PUSHBUTTON SWITCHES
ROCKER SWITCHES
ROTARY SWITCHES
SLIDE SWITCHES
SNAP ACTION SWITCHES
TACTILE SWITCHES
TOGGLE SWITCHES
CAP OPTIONS

800U SERIES PUSHBUTTON SWITCH

DPDT DIMENSIONS

M2 Termination

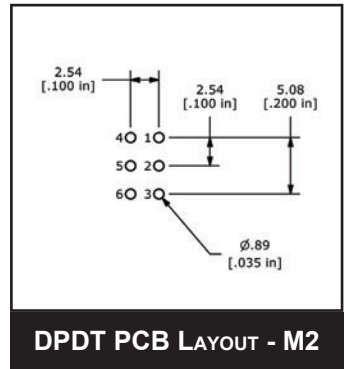
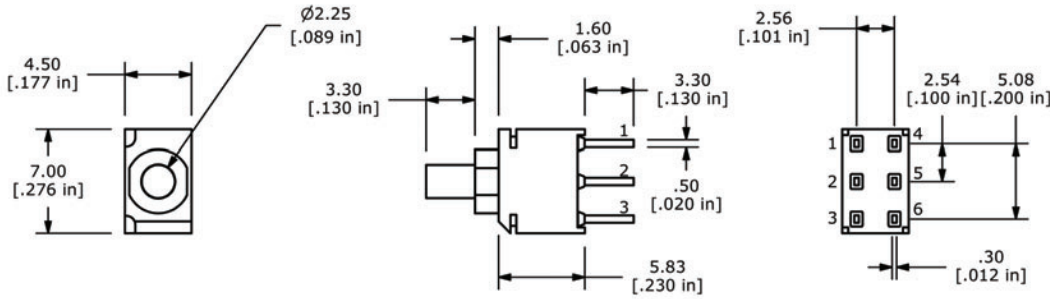

M6 Termination

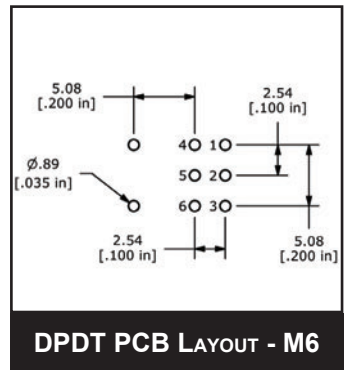
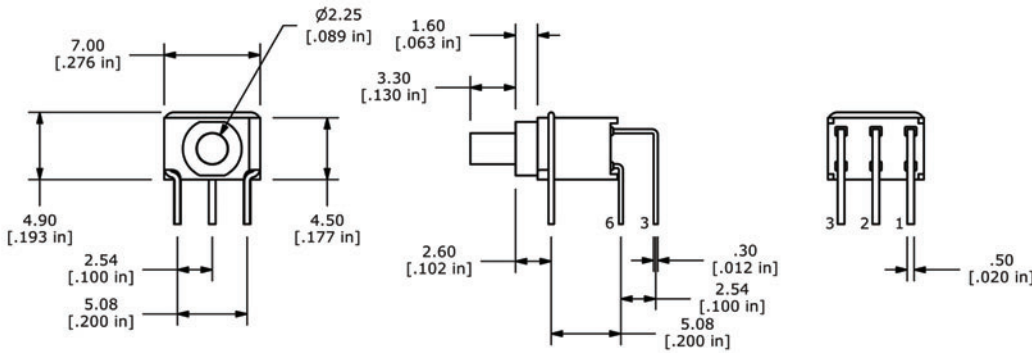

M7 Termination

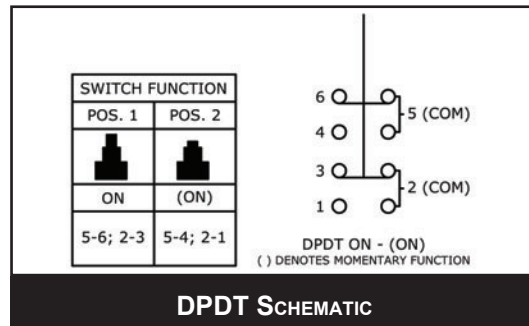
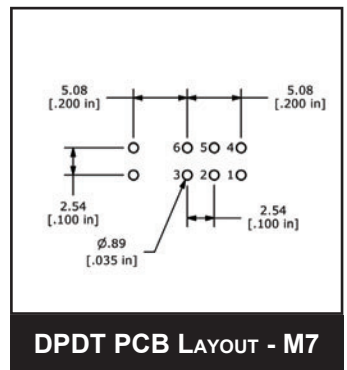
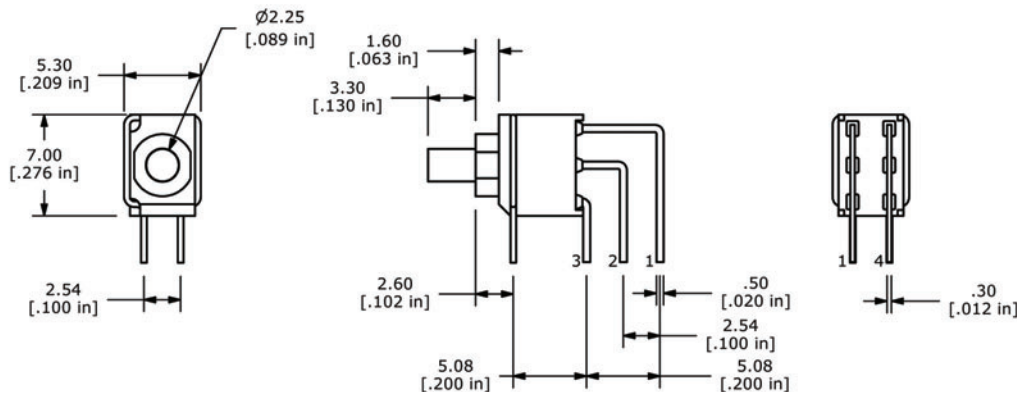

800U SERIES PUSHBUTTON SWITCH

BUTTON POSITIONING

For specifications, please refer to the dimensions on previous pages.

M2 Button

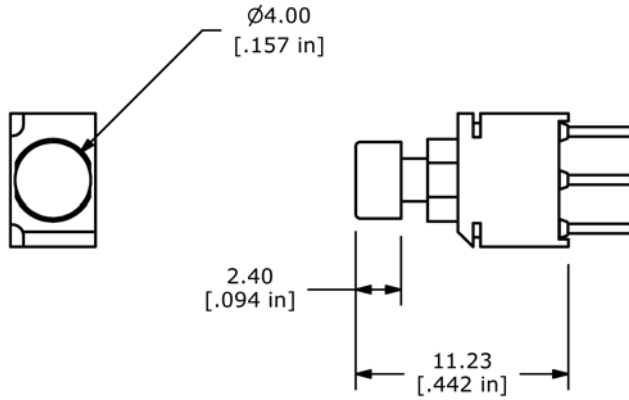

M6 Button

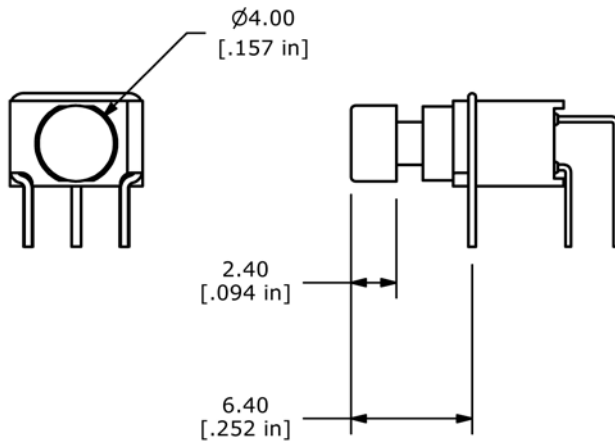

M7 Button

