

### An Integrated Male/ Female Half-pitch Stacking Connector with Board Space Adjustable from 5 to 11 mm.

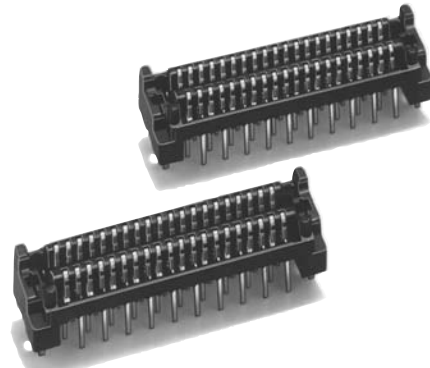

- Board space can be adjusted from 5 to 11 mm in 1-mm increments. (Surface-mounted Connectors can be adjusted from 5 to 9 mm in 1-mm increments.)
- The product line includes DIP and SMT Connectors.
- Integrated male/female Connectors.
- All models incorporate fastening pins to secure the terminals, thus preventing floating or falling over during soldering.
- The leaf contact construction resists bending.
- The XH4A conforms to UL standards (file no. E103202). (SMT Connectors not included)
- Not mated with XH2 and XH3 Half-pitch Connectors.



\* Excluding SMT connectors

#### RoHS Compliant

### Terminology

#### • SMT

The abbreviation of Surface Mount Technology.

#### • Integrated male/female Connectors

The male (plug) and female (socket) have the same shape.

### Ratings and Characteristics

Rated current	0.5 A
Rated voltage	125 VAC
Contact resistance (See note.)	30 mΩ max. (20 mV max., 100 mA max.)
Insulation resistance	1,000 MΩ min. (at 500 VDC)
Dielectric strength	650 VAC for 1 min (leakage current: 1 mA max.)
Total insertion force	1.47 N max. per contact
Total removal force	0.15 N min. per contact
Insertion durability	50 times
Ambient operating temperature	-55 to 105°C (with no condensation or icing)

**Note:** The contact resistance depends on which XH4A-□□31 Connectors are mated to each other.

### Materials and Finish

Housing	PPS (UL94 V-0)/black	
Locator	PBT (UL94 V-0)/black	
Contacts	Mating end	Phosphor bronze/nickel base, gold plating
	Terminal	Phosphor bronze/nickel base, gold flash plating
Fastening pins	Copper alloy/tin plating	

# XH4A Straight DIP Terminals

## ■ Dimensions

(unit: mm)

XH4A-□□31  
(Straight DIP Terminals)

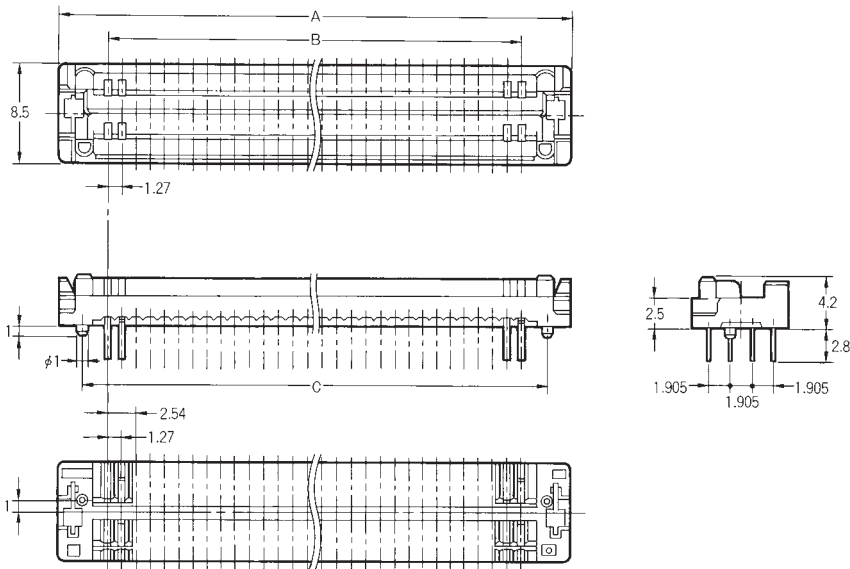
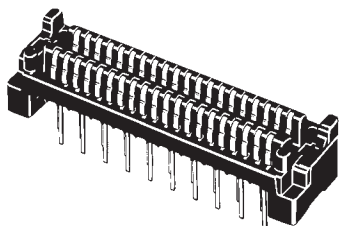

### Dimensions

Dimensions (mm)	A	B	C
No. of contacts			
40	32.73	24.13	28.63
50	39.08	30.48	34.98
60	45.43	36.83	41.33
80	58.13	49.53	54.03
100	70.83	62.23	66.73

Reference  
**Mounting holes**  
(bottom view)  
40, 60, 80, 100 contacts

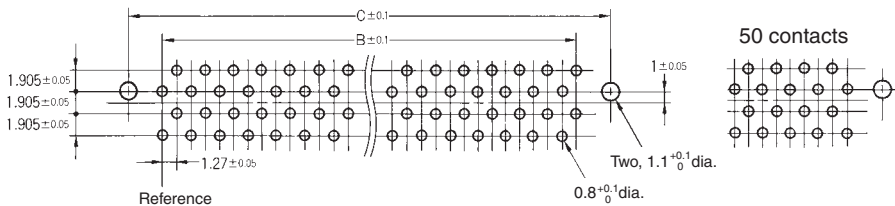

## ■ Ordering Information

Model	Straight DIP Terminals
No. of contacts	
40	XH4A-4031
50	XH4A-5031
60	XH4A-6031
80	XH4A-8031
100	XH4A-0131

# XH4A Straight DIP Terminals

## Stacking Space Adjustable in Standard Size and 1-, 2-, or 3-mm Increments

### Dimensions

(unit: mm)

- XH4A-□□31-A (Standard)
  - XH4A-□□31-1A (1-mm Increment)
  - XH4A-□□31-2A (2-mm Increments)
  - XH4A-□□31-3A (3-mm Increments)
- (Straight DIP Terminals with Fastening Pins)

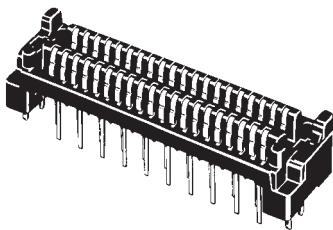

#### Dimensions

Dimensions (mm)	A	B	C
No. of contacts			
40	32.73	24.13	30.23
50	39.08	30.48	36.58
60	45.43	36.83	42.93
80	58.13	49.53	55.63
100	70.83	62.23	68.33

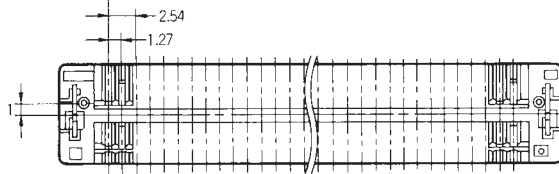
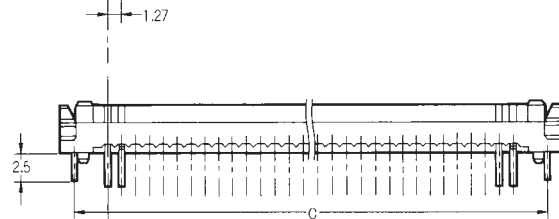
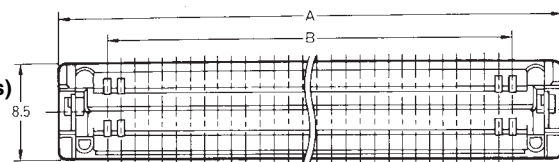

Reference

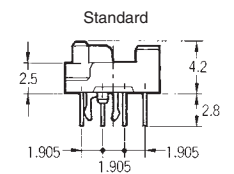
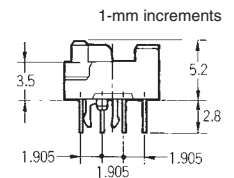
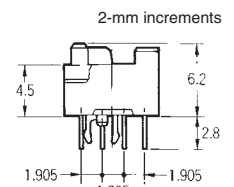
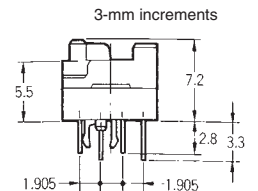

Mounting holes  
(bottom view)  
40, 60, 80, 100 contacts

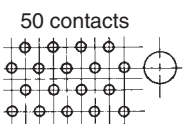
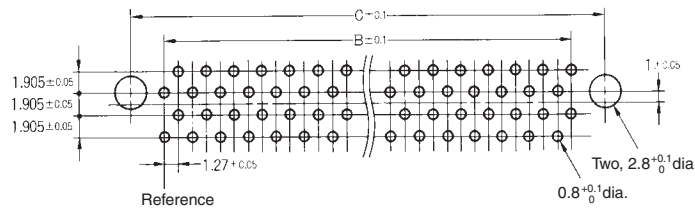

### Ordering Information

Model	Straight DIP Terminals with fastening pins (See note.) (Standard)	Straight DIP Terminals with fastening pins (See note.) (1-mm increment)	Straight DIP Terminals with fastening pins (See note.) (2-mm increments)	Straight DIP Terminals with fastening pins (See note.) (3-mm increments)
No. of contacts				
40	XH4A-4031-A	XH4A-4031-1A	XH4A-4031-2A	XH4A-4031-3A
50	XH4A-5031-A	XH4A-5031-1A	XH4A-5031-2A	XH4A-5031-3A
60	XH4A-6031-A	XH4A-6031-1A	XH4A-6031-2A	XH4A-6031-3A
80	XH4A-8031-A	XH4A-8031-1A	XH4A-8031-2A	XH4A-8031-3A
100	XH4A-0131-A	XH4A-0131-1A	XH4A-0131-2A	XH4A-0131-3A

Note: Applicable board thickness is 1.6 mm.

# XH4A SMT Terminals

## Stacking Space Adjustable in Standard Size and 1- or 2-mm Increments

### ■ Dimensions

XH4A-□□35-A (Standard)  
 XH4A-□□35-1A (1-mm Increment)  
 XH4A-□□35-2A (2-mm Increments)  
 (SMT Terminals with Fastening Pins)

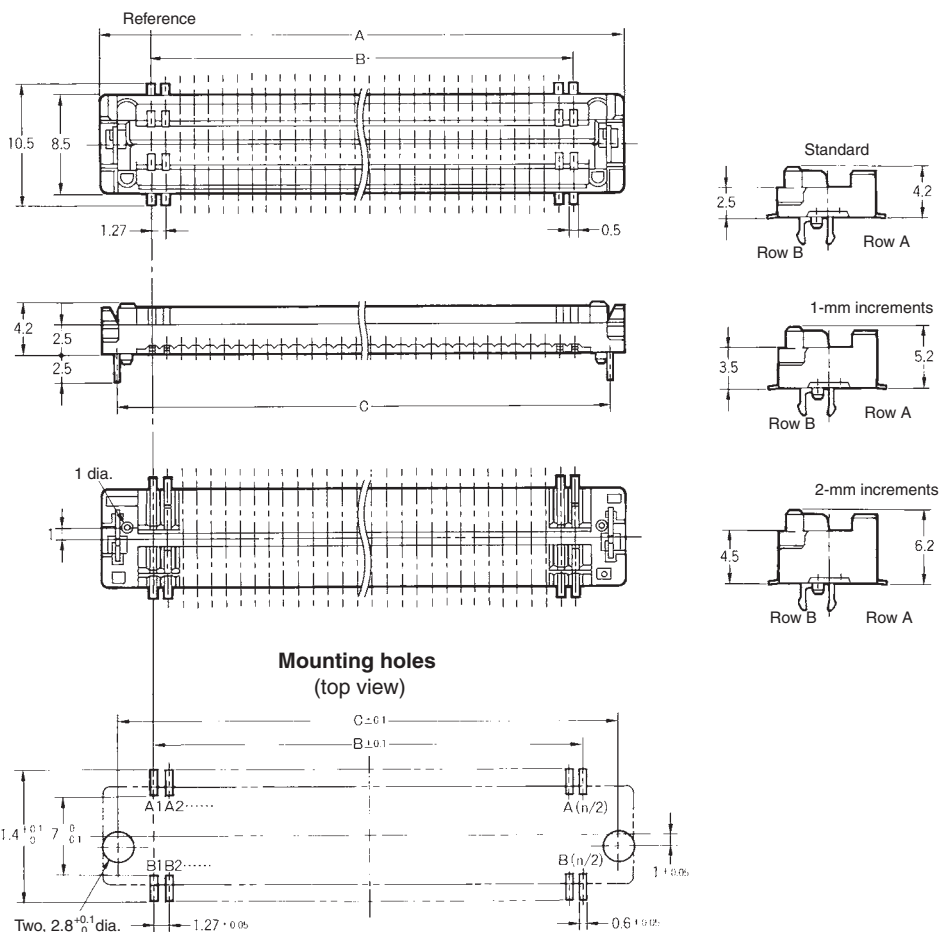
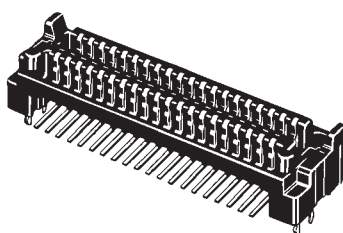

Dimensions

Dimensions (mm)	A	B	C
No. of contacts			
40	32.73	24.13	30.23
50	39.08	30.48	36.58
60	45.43	36.83	42.93
80	58.13	49.53	55.63
100	70.83	62.23	68.33

### ■ Ordering Information

Model	SMT Terminals with fastening pins (See note.) (Standard)	SMT Terminals with fastening pins (See note.) (1-mm increment)	SMT Terminals with fastening pins (See note.) (2-mm increments)
No. of contacts			
40	XH4A-4035-A	XH4A-4035-1A	XH4A-4035-2A
50	XH4A-5035-A	XH4A-5035-1A	XH4A-5035-2A
60	XH4A-6035-A	XH4A-6035-1A	XH4A-6035-2A
80	XH4A-8035-A	XH4A-8035-1A	XH4A-8035-2A
100	XH4A-0135-A	XH4A-0135-1A	XH4A-0135-2A

Note: Applicable board thickness is 1.6 mm.

■ Mating Diagram (unit: mm)

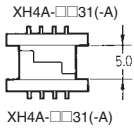
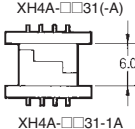
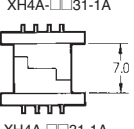
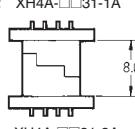
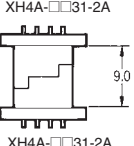
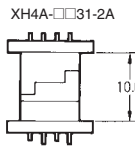
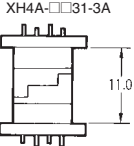

Stacked DIP Terminals

Stacking space	5 mm	6 mm	7 mm	8 mm
Mating diagram				
Stacking space	9 mm	10 mm	11 mm	
Mating diagram				

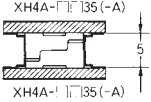
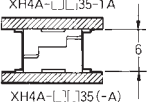
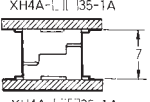
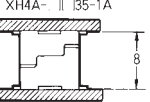
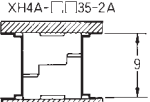
Stacked SMT Terminals

Stacking space	5 mm	6 mm	7 mm	8 mm	9 mm
Mating diagram					

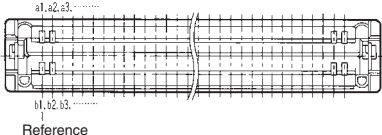
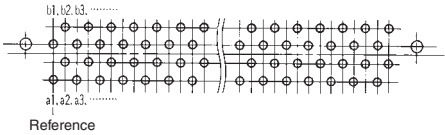
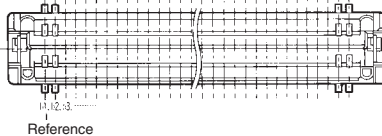
■ Contact Numbers

Item	Mated Diagram	Mounting holes
DIP Terminals		(bottom view) 
SMT Terminals		(top view) 

• The triangular mark (▼) and contact numbers are not printed on the connectors. Use the raised reference point used to prevent reverse insertion as a guide when designing boards.

• On the mating side, the row of terminals on the raised reference point side are called row a, and the row on the other side is called row b. The numbers are in the order shown.

• XH4A Half-pitch Connectors are integrated male/female connectors. The contact numbers on row a correspond to the contact numbers on row b. Be careful when using these connectors because they function slightly differently from separate male and female connectors (i.e., Plugs and Sockets).

■ Precautions

Correct Use

PCB settings

XH4A Half-pitch Connectors are male/female connectors with integrated plugs and sockets.

Refer to **Contact Numbers** above when designing boards.

Mating Compatibility

XH4 Half-pitch Connectors do not mate with XH2 or XH3 Half-pitch Connectors.

Soldering Conditions

Straight DIP Terminals (Automated Soldering)

- (1) Soldering temperature: 250±5°C
- (2) Continuous soldering time: Within 5±1 s

Be sure to wash the board after automated soldering is completed.

SMT Terminals

Recommended reflow conditions

- Pre-heat temperature: 150±10°C
- Pre-heat time: 60 to 120 s
- Soldering temperature: 200 to 240°C
- Soldering time: Within 30 s
- (Within 10 s at the maximum temperature of 240°C)

- Application examples provided in this document are for reference only. In actual applications, confirm equipment functions and safety before using the product.
- Consult your OMRON representative before using the product under conditions which are not described in the manual or applying the product to nuclear control systems, railroad systems, aviation systems, vehicles, combustion systems, medical equipment, amusement machines, safety equipment, and other systems or equipment that may have a serious influence on lives and property if used improperly. Make sure that the ratings and performance characteristics of the product provide a margin of safety for the system or equipment, and be sure to provide the system or equipment with double safety mechanisms.

**Note: Do not use this document to operate the Unit.**