

Electroformed Probe Pins

XP3B

Highly Reliable Electroformed Probe Pins. Outer spring type.

- Plunger structure to ensure stable contact.
- Highly durability due to the smooth end surfaces achieved with electroforming.

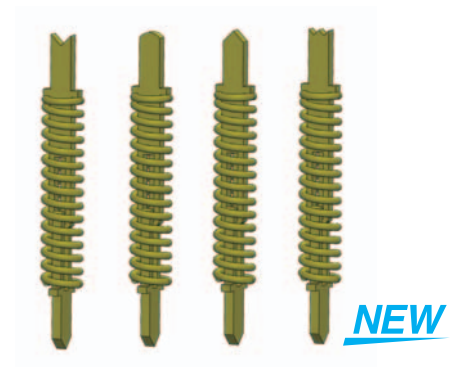

Feature

●Plunger structure to ensure stable contact.

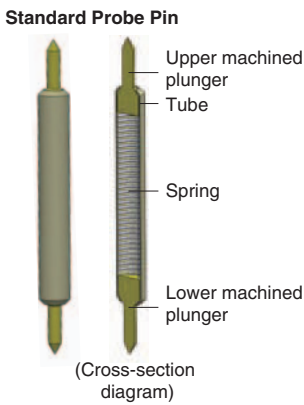

Conductive Path
 Upper plunger
 ⇒ Tube
 ⇒ Lower plunger

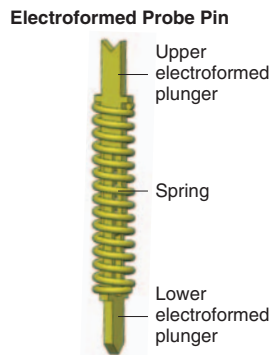

Conductive Path
 Upper plunger
 ⇒ Lower plunger

●Stable contact achieved with structure that ensures constant plunger contact.

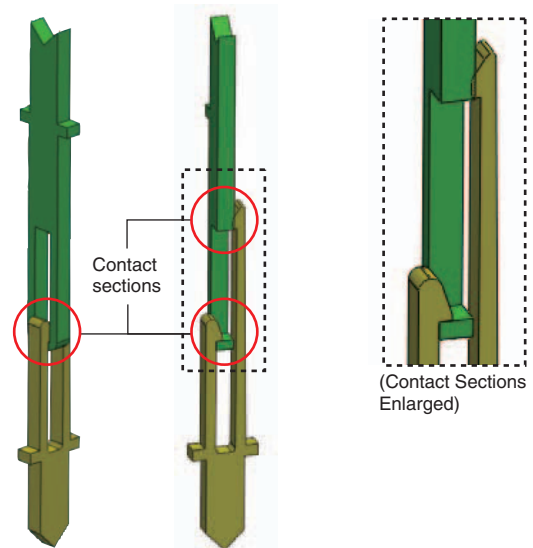

●Plunger Tip Shapes.

Plunger tip shapes other than those shown below can also be manufactured.

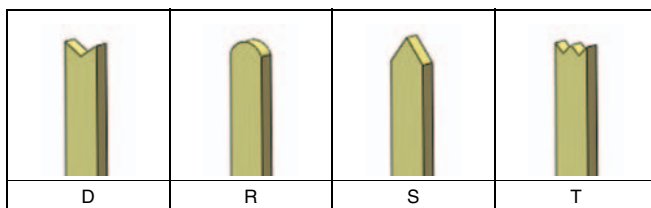

Usage Example

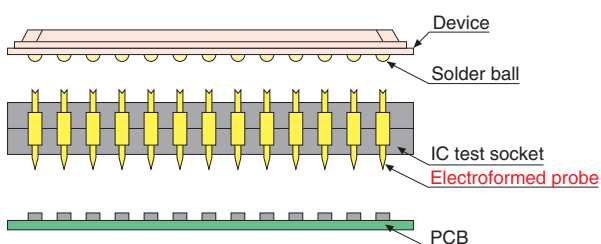

XP3B

Model Number List

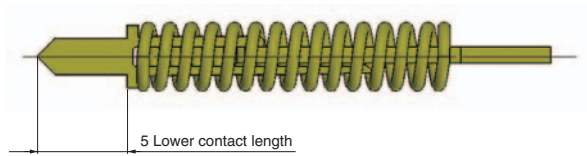
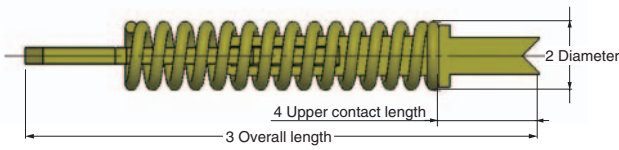

XP3B-□□□□-□□□□-□-□/□
 1 2 3 4 5 6 7 8

1	2		3		4		5		6		7		8	
Series	Diameter		Overall length		Upper contact length		Lower contact length		Plating specification		Upper contact shape		Lower contact shape	
XP3B	38	0.38 dia.	29	2.85 mm	50	0.5 mm	50	0.5 mm	1	Gold	D		D	
	30	0.30 dia.									R		R	
	23	0.23 dia.	S								S			
	20	0.20 dia.	23	2.3 mm							T		T	

Ratings and Specifications

Diameter	0.38 dia.	0.30 dia.	0.23 dia.	0.20 dia.
Model	XP3B-38□□-□□□□-□-□/□	XP3B-30□□-□□□□-□-□/□	XP3B-23□□-□□□□-□-□/□	XP3B-20□□-□□□□-□-□/□
Rated current	2A			
Contact force	30 gf min.	25 gf min.	10 gf min.	
Stroke	0.5 mm	0.5 mm	0.4 mm	0.35 mm
Contact resistance	50 mΩ max.	60 mΩ max.	80 mΩ max.	
Durability	1,000,000 operations min.			

Materials and Finish

Plunger	Nickel alloy/gold plating
Spring	SWP/gold plating

XP3B-38 0.38 Diameter for 0.5-mm Pitch

■Dimensions

(Unit: mm)

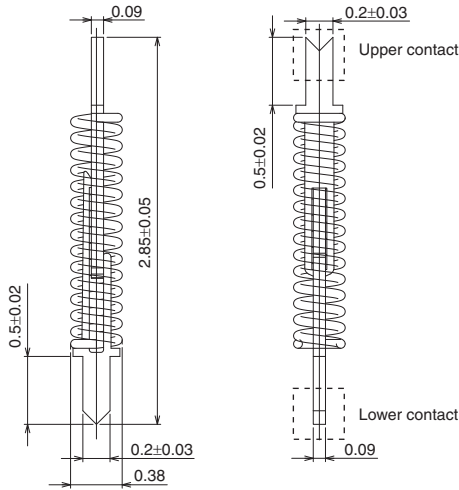

■Recommended Mounting Dimensions

(Unit: mm)

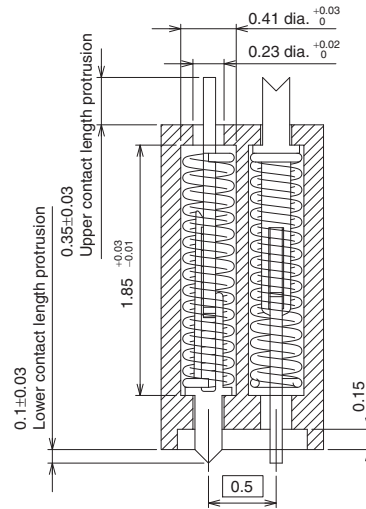

■Ordering Information

Upper contact shape	Lower contact shape	Model	Minimum ordering quantity (pieces)
D	D	XP3B-3829-5050-1-D/D	50
	R	XP3B-3829-5050-1-D/R	
	S	XP3B-3829-5050-1-D/S	
	T	XP3B-3829-5050-1-D/T	
R	D	XP3B-3829-5050-1-R/D	
	R	XP3B-3829-5050-1-R/R	
	S	XP3B-3829-5050-1-R/S	
	T	XP3B-3829-5050-1-R/T	
S	D	XP3B-3829-5050-1-S/D	
	R	XP3B-3829-5050-1-S/R	
	S	XP3B-3829-5050-1-S/S	
	T	XP3B-3829-5050-1-S/T	
T	D	XP3B-3829-5050-1-T/D	
	R	XP3B-3829-5050-1-T/R	
	S	XP3B-3829-5050-1-T/S	
	T	XP3B-3829-5050-1-T/T	

XP3B

XP3B-30 0.30 Diameter for 0.4-mm Pitch

■Dimensions

(Unit: mm)

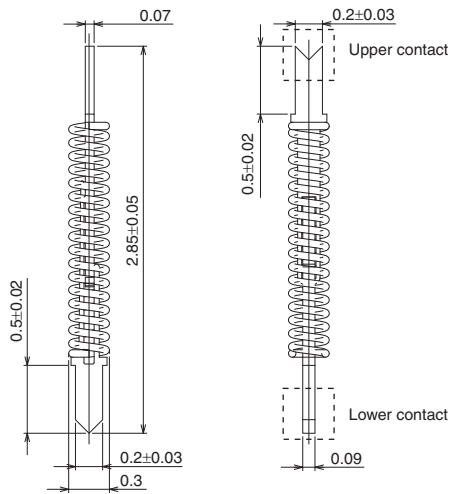





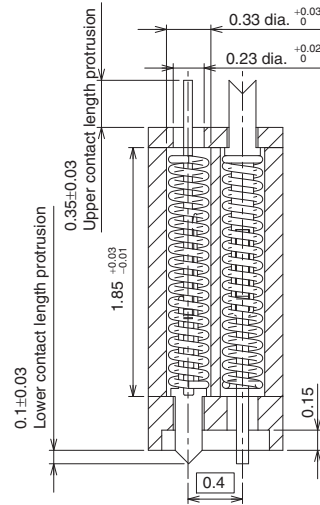















■Recommended Mounting Dimensions

(Unit: mm)



■Ordering Information

Upper contact shape	Lower contact shape	Model	Minimum ordering quantity (pieces)
	D 	XP3B-3029-5050-1-D/D	50
	R 	XP3B-3029-5050-1-D/R	
	S 	XP3B-3029-5050-1-D/S	
	T 	XP3B-3029-5050-1-D/T	
	D 	XP3B-3029-5050-1-R/D	
	R 	XP3B-3029-5050-1-R/R	
	S 	XP3B-3029-5050-1-R/S	
	T 	XP3B-3029-5050-1-R/T	
	D 	XP3B-3029-5050-1-S/D	
	R 	XP3B-3029-5050-1-S/R	
	S 	XP3B-3029-5050-1-S/S	
	T 	XP3B-3029-5050-1-S/T	
	D 	XP3B-3029-5050-1-T/D	
	R 	XP3B-3029-5050-1-T/R	
	S 	XP3B-3029-5050-1-T/S	
	T 	XP3B-3029-5050-1-T/T	

XP3B-23 0.23 Diameter for 0.35-mm Pitch

Available soon.

■Dimensions

(Unit: mm)

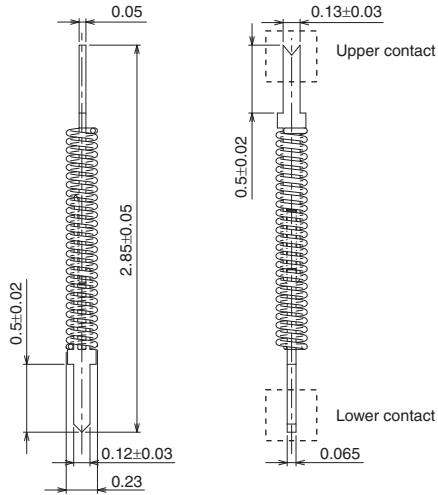

■Recommended Mounting Dimensions

(Unit: mm)

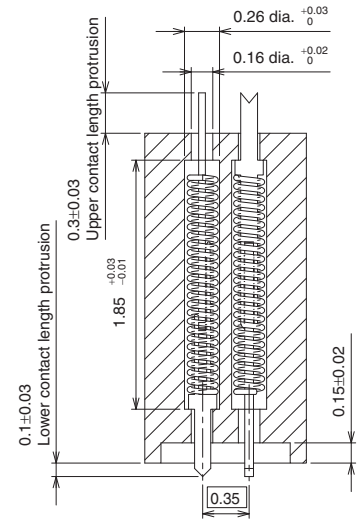

■Ordering Information

(Available soon)

Upper contact shape	Lower contact shape	Model	Minimum ordering quantity (pieces)
D	D	XP3B-2329-5050-1-D/D	50
	R	XP3B-2329-5050-1-D/R	
	S	XP3B-2329-5050-1-D/S	
	T	XP3B-2329-5050-1-D/T	
R	D	XP3B-2329-5050-1-R/D	
	R	XP3B-2329-5050-1-R/R	
	S	XP3B-2329-5050-1-R/S	
	T	XP3B-2329-5050-1-R/T	
S	D	XP3B-2329-5050-1-S/D	
	R	XP3B-2329-5050-1-S/R	
	S	XP3B-2329-5050-1-S/S	
	T	XP3B-2329-5050-1-S/T	
T	D	XP3B-2329-5050-1-T/D	
	R	XP3B-2329-5050-1-T/R	
	S	XP3B-2329-5050-1-T/S	
	T	XP3B-2329-5050-1-T/T	

XP3B

XP3B-20 0.20 Diameter for 0.3-mm Pitch

Available soon.

■Dimensions

(Unit: mm)

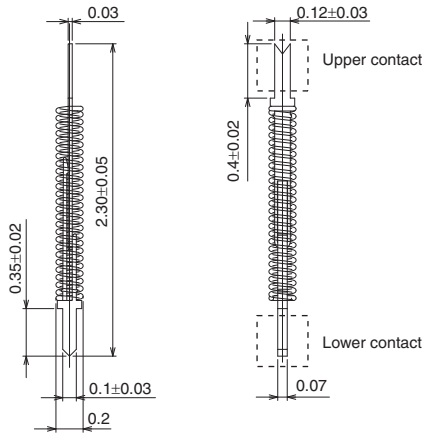

■Recommended Mounting Dimensions (Unit: mm)

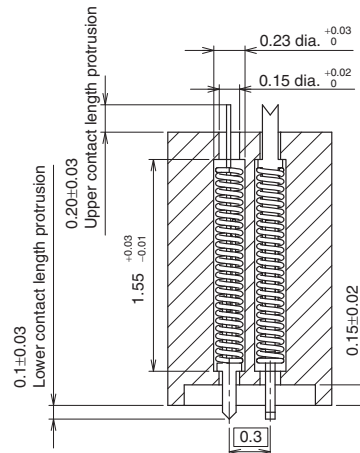

■Ordering Information (Available soon)

Upper contact shape		Lower contact shape		Model	Minimum ordering quantity (pieces)
D		D		XP3B-2023-5050-1-D/D	50
		R		XP3B-2023-5050-1-D/R	
		S		XP3B-2023-5050-1-D/S	
		T		XP3B-2023-5050-1-D/T	
R		D		XP3B-2023-5050-1-R/D	
		R		XP3B-2023-5050-1-R/R	
		S		XP3B-2023-5050-1-R/S	
		T		XP3B-2023-5050-1-R/T	
S		D		XP3B-2023-5050-1-S/D	
		R		XP3B-2023-5050-1-S/R	
		S		XP3B-2023-5050-1-S/S	
		T		XP3B-2023-5050-1-S/T	
T		D		XP3B-2023-5050-1-T/D	
		R		XP3B-2023-5050-1-T/R	
		S		XP3B-2023-5050-1-T/S	
		T		XP3B-2023-5050-1-T/T	

■ Safety Precautions

Precautions for Correct Use

● General Environmental Conditions

- (1) Use the Probe Pins in an ambient atmosphere that does not contain dust, dirt, corrosive gas, or oil so that the Probe Pins do not become contaminated.

● Stroke Conditions

- (1) Apply a load to the Probe Pins only in the axial direction. Never apply a lateral load.
- (2) The life of the Probe Pins will be drastically reduced if the recommended stroke is exceeded.

● Current Application Conditions

- (1) Apply a current when the Probe Pins are stationary after they have come into contact with the target at the recommended stroke position.
- (2) If a current is applied during the stroke, at a position other than the recommended stroke, or when the Probe Pins are not in contact with the target, the life of the Probe Pins will be drastically reduced.
- (3) The catalog value of the carrying capacity may not be met due to Probe Pin deterioration or other factors. Allow sufficient leeway when you design the actual application.

● Voltage Application Conditions

- (1) Apply a voltage when the Probe Pins are stationary after they have come into contact with the target at the recommended stroke position.
- (2) Do not apply a voltage when the Probe Pins are not in contact with the target. The Probe Pins will be damaged due to discharge immediately before they come into contact.
- (3) When a high voltage is applied to the contact probe, strictly observe the current and voltage application conditions. Also, take measures to prevent discharge or other large instantaneous currents.

● Carrying Capacity

- (1) The rated current that is given in the catalog is the maximum continuous current for 1 minute under the above conditions (general environment, stroke, current application, and voltage application).

● Resistance

- (1) If a large current is applied, the resistance may increase due to deterioration of the contacts and internal components.
- (2) As the number of strokes increases, the resistance may increase due to deterioration of the contacts and internal components.

● Durability

- (1) The durability specification that is given in the catalog is a guideline for the number of times that the Probe Pins can be used without problems at 10 mA.
- (2) Depending on the operating environment and conditions, the Probe Pins may need to be replaced sooner than given in the specifications due to increased resistance, reduced contact force, or other factors. Replace the Probe Pins as required by the actual application.

● Contact Force

- (1) If the current is increased, heat generated by the Probe Pins will reduce the contact force.

● Recommended Mounting Dimensions

- (1) The dimensions are reference values. Actual values will depend on the material and thickness of the resin plate.

Terms and Conditions Agreement

Read and understand this catalog.

Please read and understand this catalog before purchasing the products. Please consult your OMRON representative if you have any questions or comments.

Warranties.

- (a) Exclusive Warranty. Omron's exclusive warranty is that the Products will be free from defects in materials and workmanship for a period of twelve months from the date of sale by Omron (or such other period expressed in writing by Omron). Omron disclaims all other warranties, express or implied.
- (b) Limitations. OMRON MAKES NO WARRANTY OR REPRESENTATION, EXPRESS OR IMPLIED, ABOUT NON-INFRINGEMENT, MERCHANTABILITY OR FITNESS FOR A PARTICULAR PURPOSE OF THE PRODUCTS. BUYER ACKNOWLEDGES THAT IT ALONE HAS DETERMINED THAT THE PRODUCTS WILL SUITABLY MEET THE REQUIREMENTS OF THEIR INTENDED USE.

Omron further disclaims all warranties and responsibility of any type for claims or expenses based on infringement by the Products or otherwise of any intellectual property right. (c) Buyer Remedy. Omron's sole obligation hereunder shall be, at Omron's election, to (i) replace (in the form originally shipped with Buyer responsible for labor charges for removal or replacement thereof) the non-complying Product, (ii) repair the non-complying Product, or (iii) repay or credit Buyer an amount equal to the purchase price of the non-complying Product; provided that in no event shall Omron be responsible for warranty, repair, indemnity or any other claims or expenses regarding the Products unless Omron's analysis confirms that the Products were properly handled, stored, installed and maintained and not subject to contamination, abuse, misuse or inappropriate modification. Return of any Products by Buyer must be approved in writing by Omron before shipment. Omron Companies shall not be liable for the suitability or unsuitability or the results from the use of Products in combination with any electrical or electronic components, circuits, system assemblies or any other materials or substances or environments. Any advice, recommendations or information given orally or in writing, are not to be construed as an amendment or addition to the above warranty.

See <http://www.omron.com/global/> or contact your Omron representative for published information.

Limitation on Liability; Etc.

OMRON COMPANIES SHALL NOT BE LIABLE FOR SPECIAL, INDIRECT, INCIDENTAL, OR CONSEQUENTIAL DAMAGES, LOSS OF PROFITS OR PRODUCTION OR COMMERCIAL LOSS IN ANY WAY CONNECTED WITH THE PRODUCTS, WHETHER SUCH CLAIM IS BASED IN CONTRACT, WARRANTY, NEGLIGENCE OR STRICT LIABILITY.

Further, in no event shall liability of Omron Companies exceed the individual price of the Product on which liability is asserted.

Suitability of Use.

Omron Companies shall not be responsible for conformity with any standards, codes or regulations which apply to the combination of the Product in the Buyer's application or use of the Product. At Buyer's request, Omron will provide applicable third party certification documents identifying ratings and limitations of use which apply to the Product. This information by itself is not sufficient for a complete determination of the suitability of the Product in combination with the end product, machine, system, or other application or use. Buyer shall be solely responsible for determining appropriateness of the particular Product with respect to Buyer's application, product or system. Buyer shall take application responsibility in all cases.

NEVER USE THE PRODUCT FOR AN APPLICATION INVOLVING SERIOUS RISK TO LIFE OR PROPERTY OR IN LARGE QUANTITIES WITHOUT ENSURING THAT THE SYSTEM AS A WHOLE HAS BEEN DESIGNED TO ADDRESS THE RISKS, AND THAT THE OMRON PRODUCT(S) IS PROPERLY RATED AND INSTALLED FOR THE INTENDED USE WITHIN THE OVERALL EQUIPMENT OR SYSTEM.

Programmable Products.

Omron Companies shall not be responsible for the user's programming of a programmable Product, or any consequence thereof.

Performance Data.

Data presented in Omron Company websites, catalogs and other materials is provided as a guide for the user in determining suitability and does not constitute a warranty. It may represent the result of Omron's test conditions, and the user must correlate it to actual application requirements. Actual performance is subject to the Omron's Warranty and Limitations of Liability.

Change in Specifications.

Product specifications and accessories may be changed at any time based on improvements and other reasons. It is our practice to change part numbers when published ratings or features are changed, or when significant construction changes are made. However, some specifications of the Product may be changed without any notice. When in doubt, special part numbers may be assigned to fix or establish key specifications for your application. Please consult with your Omron's representative at any time to confirm actual specifications of purchased Product.

Errors and Omissions.

Information presented by Omron Companies has been checked and is believed to be accurate; however, no responsibility is assumed for clerical, typographical or proofreading errors or omissions.

- Application examples provided in this document are for reference only. In actual applications, confirm equipment functions and safety before using the product.
- Consult your OMRON representative before using the product under conditions which are not described in the manual or applying the product to nuclear control systems, railroad systems, aviation systems, vehicles, combustion systems, medical equipment, amusement machines, safety equipment, and other systems or equipment that may have a serious influence on lives and property if used improperly. Make sure that the ratings and performance characteristics of the product provide a margin of safety for the system or equipment, and be sure to provide the system or equipment with double safety mechanisms.

Note: Do not use this document to operate the Unit.