





### Omron's Next Generation of Miniature Photoelectric Sensors

- Utilizes Omron's "Hyper LED" technology to achieve the industry's smallest visible red beam
- Self-contained sensor ideal for compact applications
- "Pin-point" beam for detecting extremely small objects
- Offered in both flat and rectangular body styles
- Retroreflective model employs Omron's Free-Angle Optics technology (FAO) to detect objects as small as 2 mm dia
- Convergent-beam model spot diameter is 0.15 mm
- Through-beam model is capable of sensing distances of 1 meter with a 2 mm target diameter
- CE conformance



## Ordering Information

### ■ PHOTOELECTRIC SENSORS

Sensor type		Sensing method						
		Through-beam		Retroreflective	Diffuse reflective	Convergent-beam		
Appearance		Side-view 	Flat 	Side-view 	Flat 	Side-view 		
Sensing distance		1 m	500 mm	10 to 200 mm	5 to 30 mm	5 to 15 mm	5 to 30 mm	
Part number	Light-ON	NPN	<b>E3T-ST11</b>	<b>E3T-FT11</b>	<b>E3T-SR11</b>	<b>E3T-FD11N</b>	<b>E3T-SL11</b>	<b>E3T-SL21</b>
		PNP	<b>E3T-ST13</b>	<b>E3T-FT13</b>	<b>E3T-SR13</b>	<b>E3T-FD13N</b>	<b>E3T-SL13</b>	<b>E3T-SL23</b>
	Dark-ON	NPN	<b>E3T-ST12</b>	<b>E3T-FT12</b>	<b>E3T-SR12</b>	<b>E3T-FD12N</b>	<b>E3T-SL12</b>	<b>E3T-SL22</b>
		PNP	<b>E3T-ST14</b>	<b>E3T-FT14</b>	<b>E3T-SR14</b>	<b>E3T-FD14N</b>	<b>E3T-SL14</b>	<b>E3T-SL24</b>

Note: All through-beam models are packaged and sold as pairs (one transmitter and one receiver).

## ■ ACCESSORIES (ORDER SEPARATELY)

### Slits (Apertures)

Slits for sensor models	Slit width	Sensing distance	Minimum sensing object (typical)	Comments	Part number
E3T-ST1□	0.5 dia.	50 mm	0.5 mm wide	One each for Emitter and Receiver	E39-S63
	1 dia.	100 mm	1 mm wide		

Slits for sensor models	Slit width	Sensing distance	Minimum sensing object (typical)	Comments	Part number
E3T-FT1□	0.5 dia.	50 mm	0.5 mm wide	One each for Emitter and Receiver	E39-S64
	1 dia.	100 mm	1 mm wide		

### Reflectors



Item	Sensing distance	Minimum sensing object (typical)	Part number
Compact retroreflective model	10 to 200 mm	2 mm wide	E39-R4 (See Note.)
	10 to 100 mm		E39-R37

Note: E39-R4 reflector included with the E3T-SR1□ (can also be ordered separately).

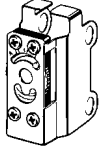
### Adjustable Aperture

For sensor models	Appearance	Part number
E3T-ST1□		E39-E10

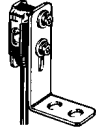
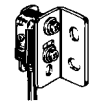
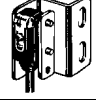
### Mounting Brackets

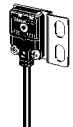
For sensor models	Appearance	Comments	Part number
E3T-S□		Two mounting brackets are required for through-beam models.	E39-L116
			E39-L117
			E39-L118
E3T-F□		E39-L119	
		E39-L120	

# Specifications

## ■ RATINGS/CHARACTERISTICS

Sensing method		Through-beam				Retroreflective		Convergent beam				Diffuse reflective	
Shape		Side-view		Flat		Side-view						Flat	
Output type		NPN	PNP	NPN	PNP	NPN	PNP	NPN	PNP	NPN	PNP	NPN	PNP
Part number	Light-ON	-ST11	-ST13	-FT11	-FT13	-SR11	-SR13	-SL11	-SL13	-SL21	-SL23	-FD11N	-FD13N
	Dark-ON	-ST12	-ST14	-FT12	-FT14	-SR12	-SR14	-SL12	-SL14	-SL22	-SL24	-FD12N	-FD14N
Sensing distance		1 m (adjustable aperture is available)		500 mm		10 to 200 mm (with the E39-R4)		5 to 15 mm (50 x 50 mm Kodak white card)		5 to 30 mm (50 x 50 mm Kodak white card)		5 to 30 mm (50 x 50 mm Kodak white card)	
Standard sensing target		2 mm dia. min.				10 mm dia. min.		---					
Min. sensing target (typical)		2 mm dia. min.				2 mm dia. (sensing distance at 100 mm)		0.15 mm dia. (sensing distance at 10 mm)					
Differential travel		---						2 mm max.		6 mm max.		6 mm max.	
Optical angle	Emitter	3° to 10°		3° to 13°		2° to 5°		---					
	Receiver	3° to 70°		3° to 70°		---							
Light source (wave length)		Red LED ("Pin-point" LED) ( $\lambda=670$ nm)											
Power supply voltage		12 to 24 VDC $\pm 10\%$ , ripple (p-p) 10% max.											24 VDC $\pm 10\%$
Current consumption		12 mA max. emitter/receiver				20 mA max.							
Output		Open collector, load current: 50 mA max. at 24 VDC, residual voltage: 1 V max., operation mode: Light-ON or Dark-ON (separate models)											
Circuit protection (See Precautions Section.)		Protection from reversed and output short-circuit				Protection from reversed polarity, output short-circuit, and mutual interference							
Response time		1 ms max. each for on and off											
Ambient light immunity	Incandescent lamp	5,000 lx max.											
	Sunlight	10,000 lx max.											
Ambient temperature	Operating	-25°C to 55°C (-13°F to 131°F)											
	Storage	-40°C to 70°C (-40°F to 158°F) with no icing or condensation											
Ambient humidity	Operating	35% to 85% RH											
	Storage	35% to 95% RH (with no condensation)											
Insulation resistance		20 M $\Omega$ min. (at 500 VDC)											
Dielectric strength		1,000 VAC, 50/60 Hz for 1 min											
Vibration resistance		10 to 2,000 Hz, 1.5-mm double amplitude or 300 m/s <sup>2</sup> (approx. 30G) for 0.5 hrs each in X, Y, and Z axis											
Shock resistance		1,000 m/s <sup>2</sup> (approx. 100G) 3 times each in X, Y, and Z axis											
Enclosure rating		IEC60529: IP67											
Connection method		Pre-leaded (standard length: 2 m)											
Weight (with packaging)		Approx. 40 g				Approx. 20 g							
Materials	Case	PBT											
	Lens and cover	Polycarbonate											
Accessories included		Two each of M2 mounting screws, spring washers, and flat washers, and reflector (E39-R4: retroreflective model only)											

# Engineering Data

## ■ EXCESS GAIN VS. SET DISTANCE (TYPICAL)

**E3T-ST1** □ (Through-beam)

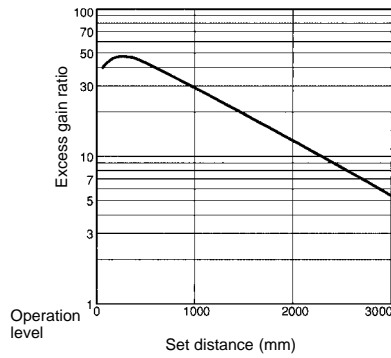

**E3T-FT1** □ (Through-beam)

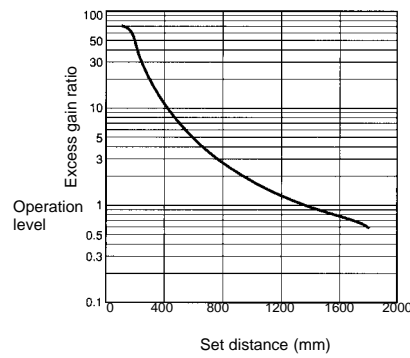

**E3T-SR1** □ with E39-R4 (Retroreflective)

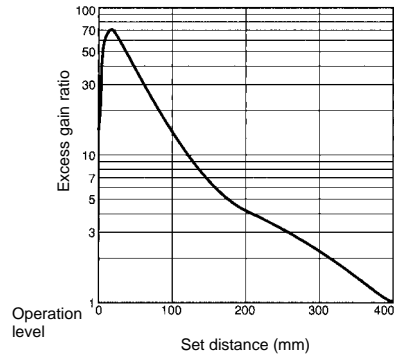

**E3T-FD1** □ (Diffuse Reflective)

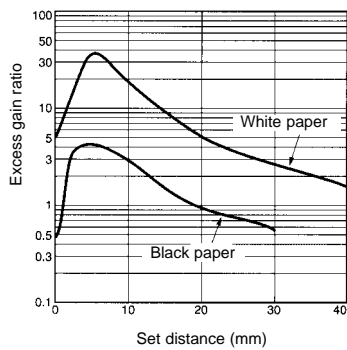

**E3T-SL1** □ (Convergent Beam)

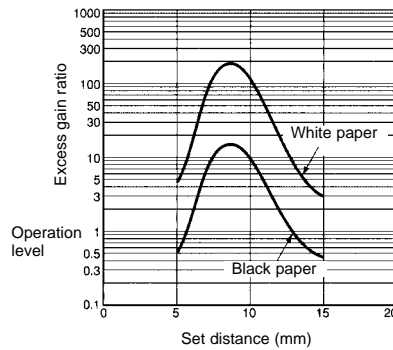

**E3T-SL2** □ (Convergent Beam)

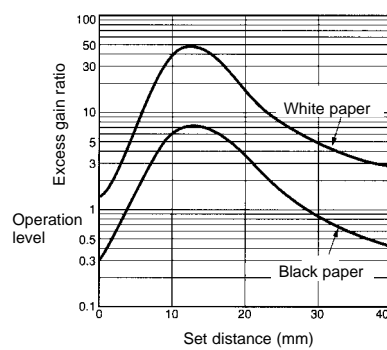

■ PARALLEL OPERATING RANGE (TYPICAL)

E3T-ST1□ with Slit (Aperture)  
(Through-beam)

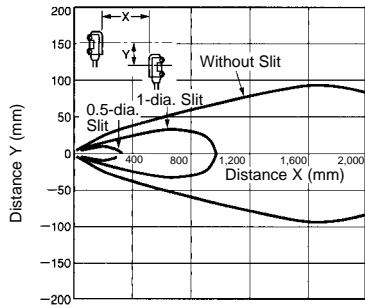

E3T-ST1□ with Slit (Enlarged graph)  
(Through-beam)

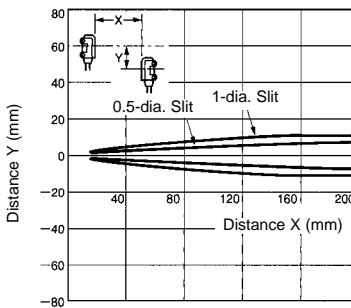

E3T-SR1□ with E39-R4  
(Retroreflective)

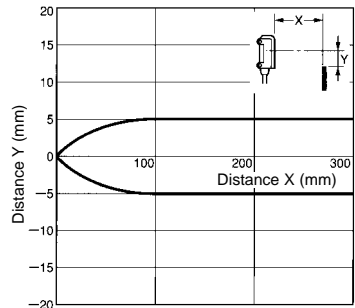

E3T-FT1□ with Slit (Through-beam)

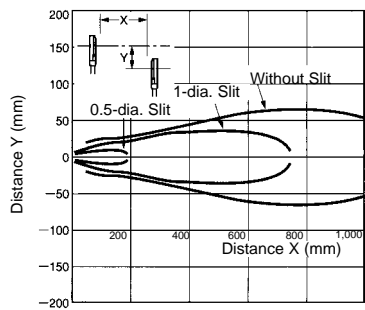

E3T-FT1□ with Slit (Enlarged graph)  
(Through-beam)

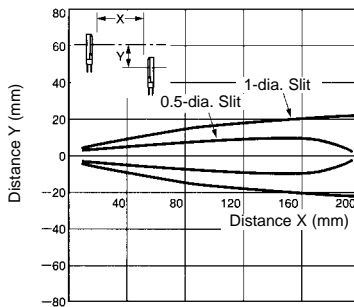

■ ANGLE CHARACTERISTICS (TYPICAL)

E3T-SL1□  
(Up and Down)

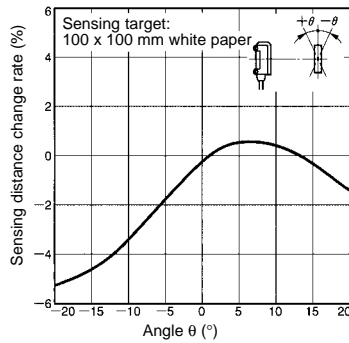

E3T-SL1□  
(Left and Right)

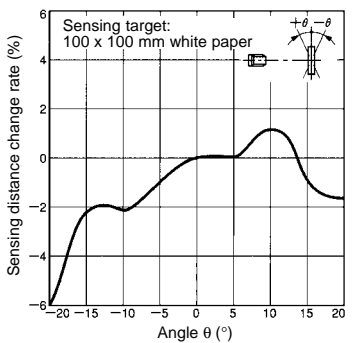

**■ CLOSE-DISTANCE SENSING CAPABILITY (TYPICAL)**

E3T-SL1□, E3T-SL2□, E3T-FD1□

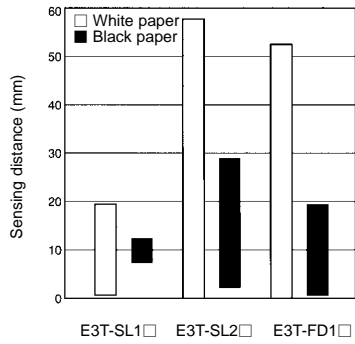

**■ SENSING TARGET SIZE VS. SENSING DISTANCE (TYPICAL)**

E3T-SL1□

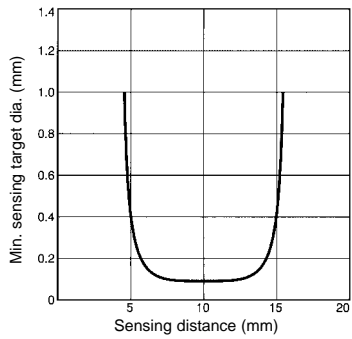

E3T-FD1□, E3T-SL2□

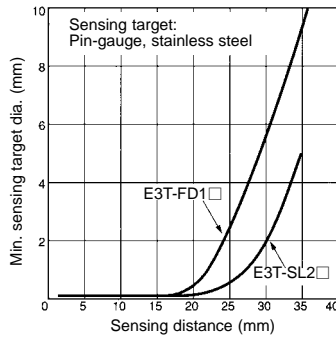

**■ OPERATION RANGE (TYPICAL)**

E3T-FD1□ (Diffuse Reflective)

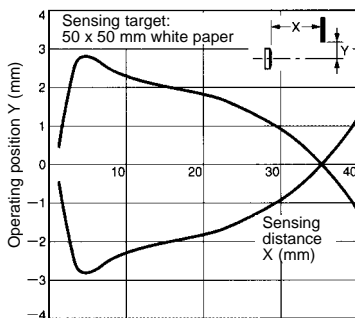

E3T-SL1□ (Convergent Beam)

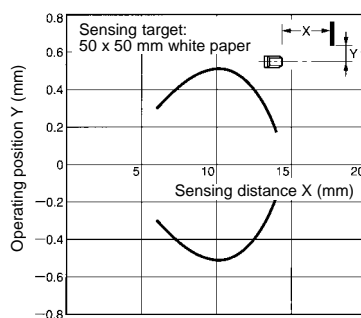

E3T-SL2□ (Convergent Beam)

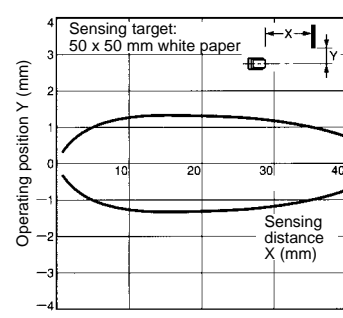

■ SENSING DISTANCE CHARACTERISTICS OF ADJUSTABLE APERTURE (WHEN COMPLETING OPTICAL AXIS ADJUSTMENT)

E3T-SL1□ with E39-E10

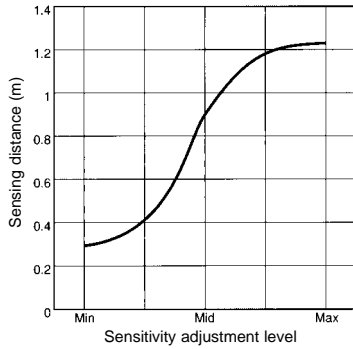

Operation

■ OUTPUT CIRCUITS

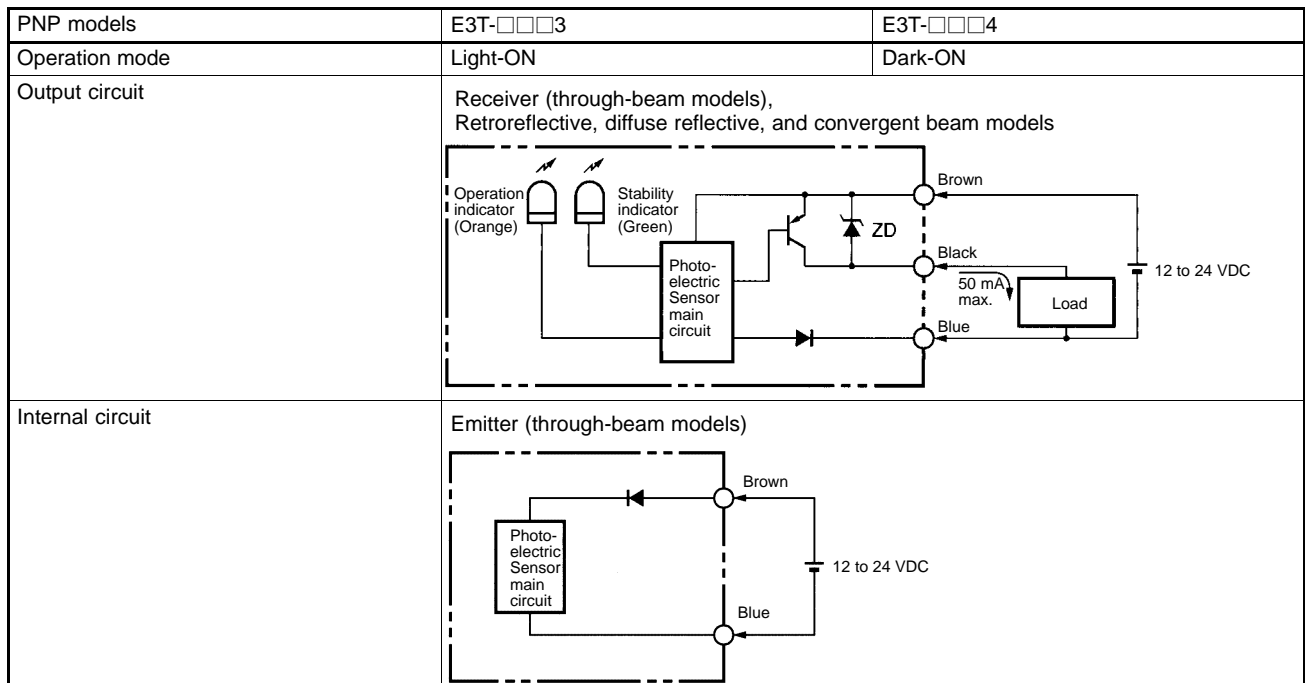
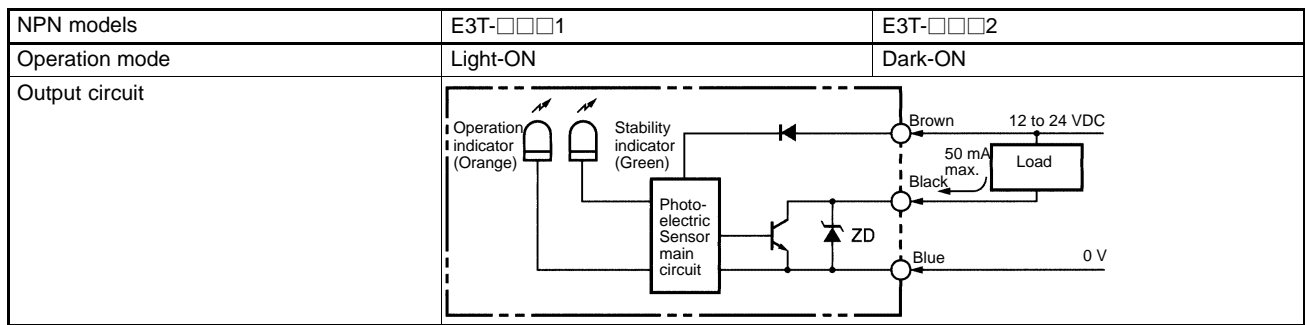

**■ TIMING CHART**

Diffuse and convergent beam	<b>Light-ON</b>		<b>Dark-ON</b>	
	Target present		Target present	
	Target not present		Target not present	
	Operation indicator (orange)	ON OFF	Operation indicator (orange)	ON OFF
	Output transistor	ON OFF	Output transistor	ON OFF
	Load	Energized De-energized	Load	Energized De-energized
Retroreflective/through-beam	<b>Light-ON</b>		<b>Dark-ON</b>	
	Target present		Target present	
	Target not present		Target not present	
	Operation indicator (orange)	ON OFF	Operation indicator (orange)	ON OFF
	Output transistor	ON OFF	Output transistor	ON OFF
	Load	Energized De-energized	Load	Energized De-energized

**Dimensions**

Unit: mm (inch)

**■ SIDE-VIEW SENSORS**

(Through-beam Models)

- E3T-ST11
- E3T-ST12
- E3T-ST13
- E3T-ST14

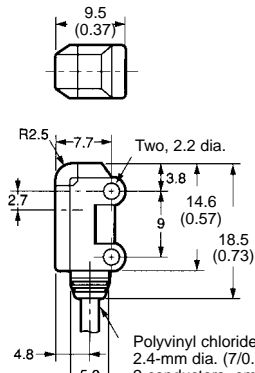
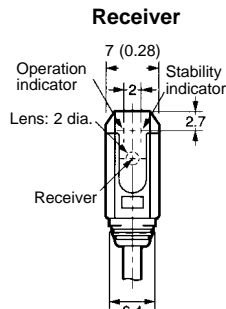
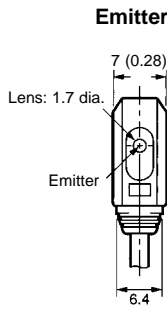
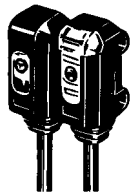

Polyvinyl chloride-covered cable,  
2.4-mm dia. (7/0.127 dia.),  
2 conductors, emitter  
3 conductors, receivers  
Standard length: 2m

**Mounting Holes**

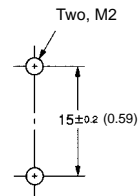



**Retroreflective Models**

- E3T-SR11
- E3T-SR12
- E3T-SR13
- E3T-SR14

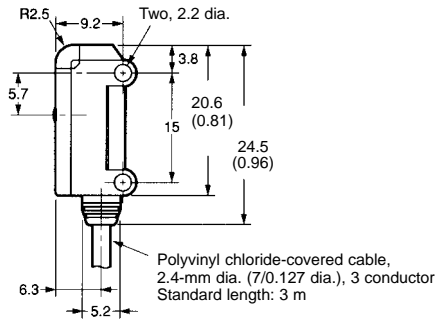
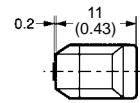
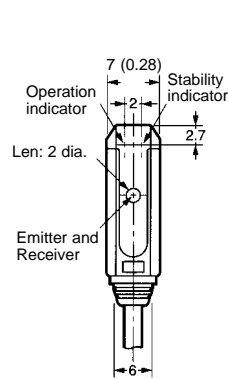

**Mounting Holes**

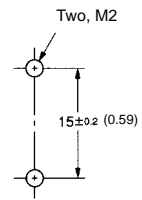

**Convergent-beam Models**

- E3T-SL11
- E3T-SL12
- E3T-SL13
- E3T-SL14
- E3T-SL21
- E3T-SL22
- E3T-SL23
- E3T-SL24

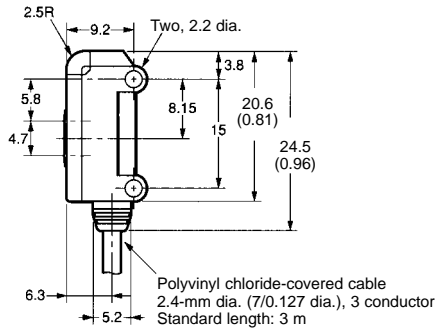
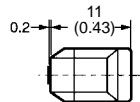
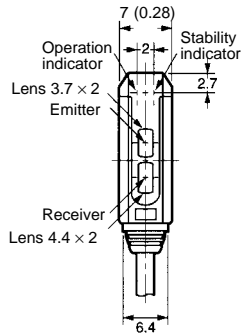

**Mounting Holes**

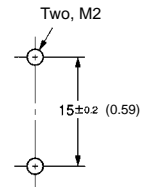

Unit: mm (inch)

■ FLAT THIN SENSORS

Through-beam Emitter and Receiver Models

E3T-FT11  
E3T-FT12  
E3T-FT13  
E3T-FT14

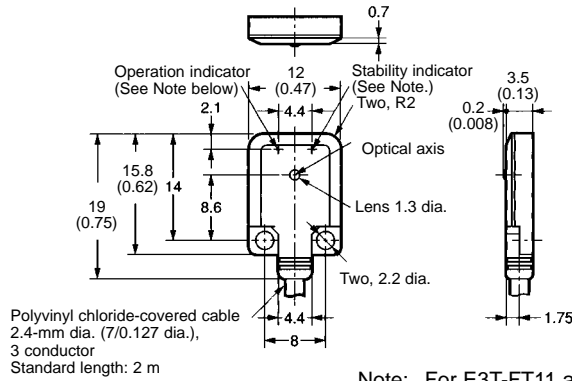
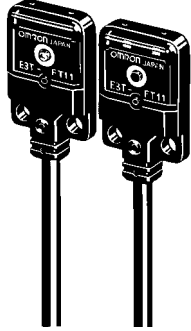

Mounting Holes

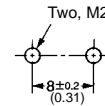

Note: For E3T-FT11 and E3T-FT12 Receivers only.

Diffuse Reflective Models

E3T-FD11-N  
E3T-FD12-N  
E3T-FD13-N  
E3T-FD14-N

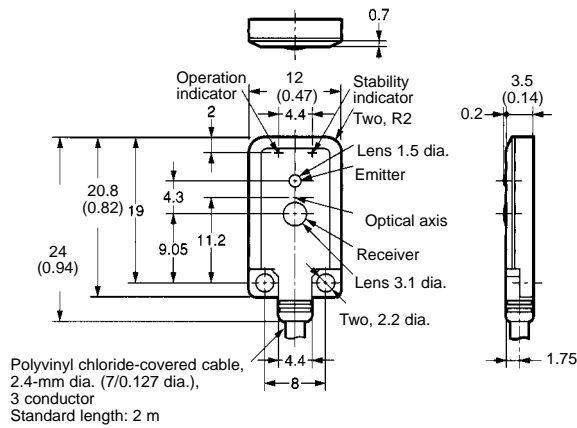
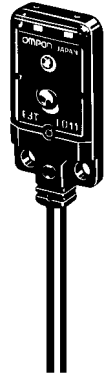

Mounting Holes

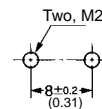

■ REFLECTORS

Retroreflector

E39-R4 (Provided with the E3T-SR1□)

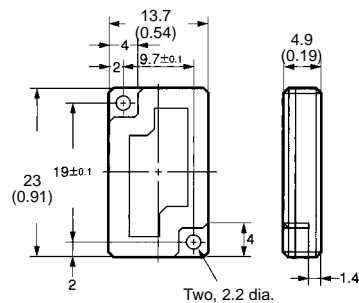
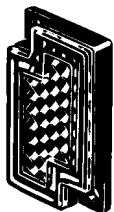

## E39-R37 Reflector

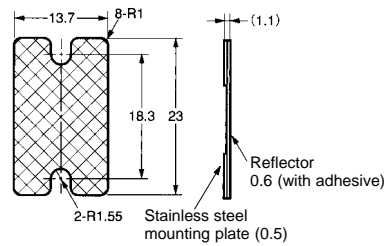
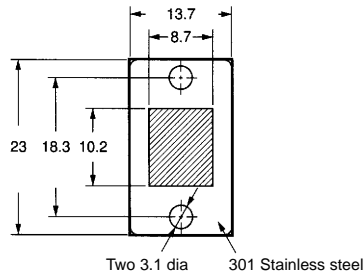
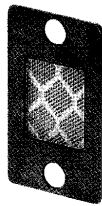

Note: A reflector and a stainless steel mounting plate are supplied together as a set.

## ■ SLITS/APERTURES (ORDER SEPARATELY)

## E39-S63 (use with E3T-ST1□)

## Shown with Sensor

## E39-S64 (use with E3T-FT1□)

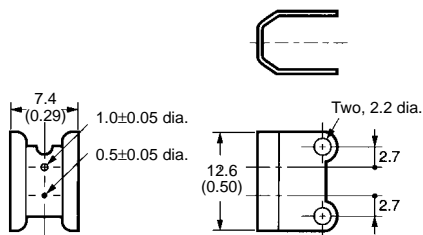

Material:  
0.2-mm-thick stainless steel  
(301 Stainless)

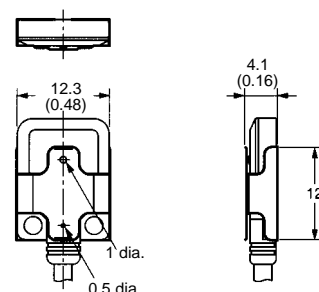
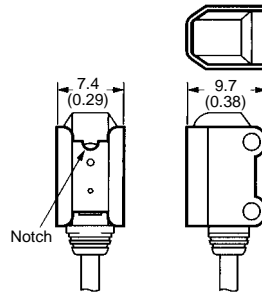

Note: Align the notch direction of the slit when installing on the Emitter and Receiver.

## Adjustable Aperture

## E39-E10 (use with E3T-ST1□)

With the Adjustable Aperture Unit in place

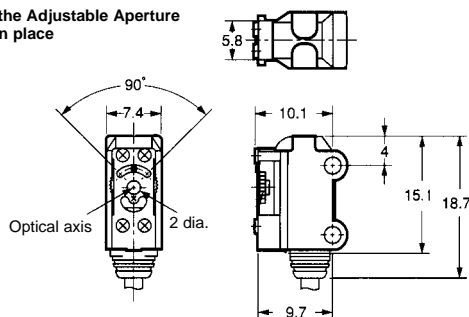

### Use of E39-E10 Adjustable Aperture (Example Dark-ON: E3T-ST12/ST14)

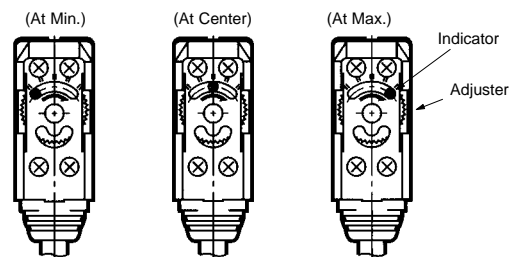

For Dark-ON:

1. Mount the unit on the receiver.
2. Set the adjuster of the Unit to Max (factory setting is at Max).
3. Adjust the optical axis (align) and tighten mounting hardware.
4. Place a target between emitter and receiver and gradually turn the adjuster counterclockwise toward the Min side. Stop turning the adjuster when the operation indicator and stability indicator (green) turn ON.
5. Remove the target and confirm that the operation indicator is OFF and the stability indicator (green) is ON.

Note: For Light-ON, adjustment is similar, except that indicators would operate in opposite manner as with Dark-ON.

Unit: mm (inch)

**■ MOUNTING BRACKETS**

**E39-L116 (use with E3T-S□□□) Order Separately**

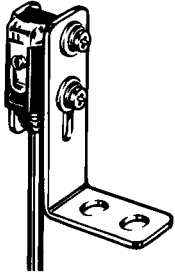

Material: 1.2-mm-thick stainless steel (SS 304)

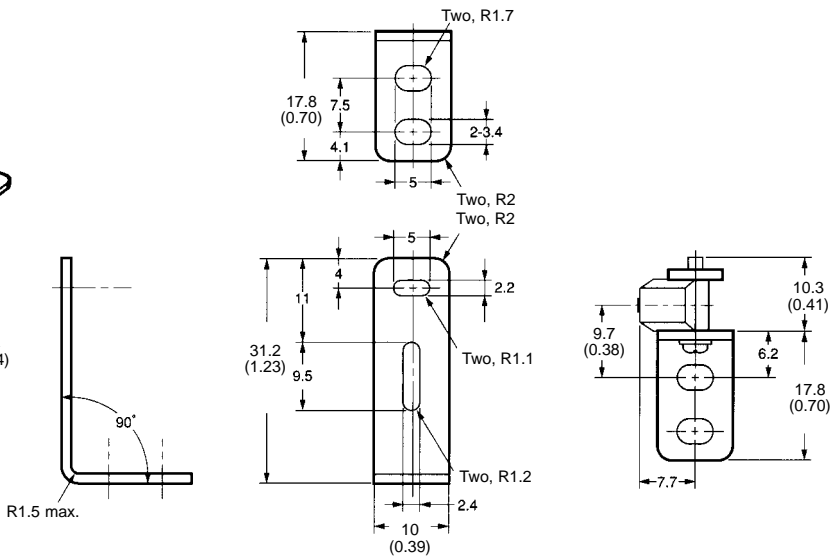

**E39-L116 (use with E3T-ST1□)**

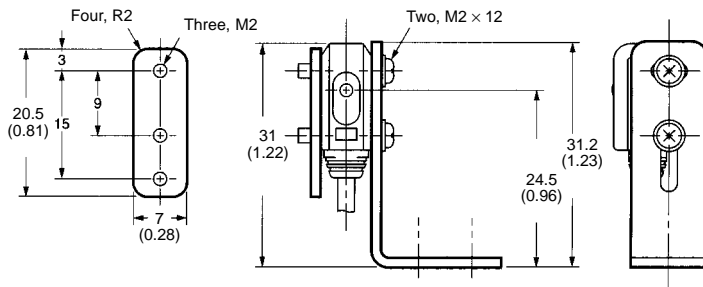

Order brackets separately.

E39-L117 (use with E3T-S□□□)

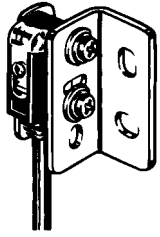

Material: 1.2-mm-thick stainless steel (SS 304)

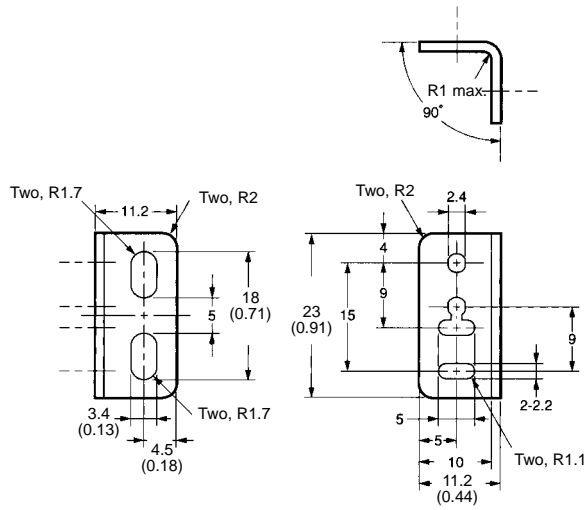

E39-L117 (shown with E3T-ST1□)

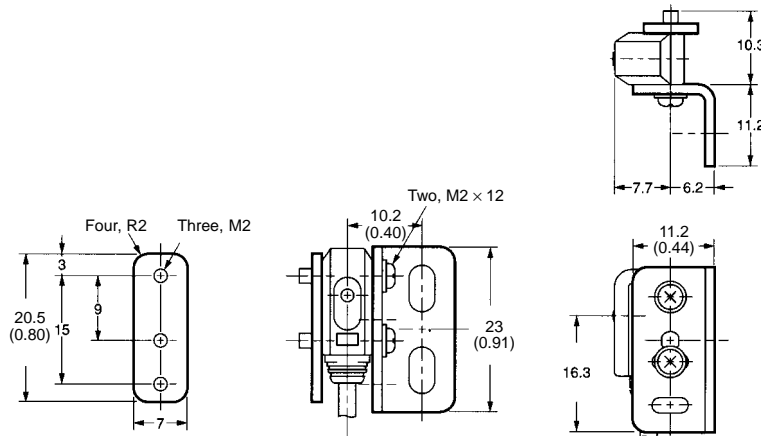

Unit: mm (inch)

Order brackets separately.

**E39-L118 (use with E3T-S□□□)**

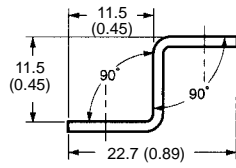
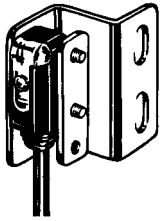

Material: 1.2-mm-thick stainless steel (SS 304)

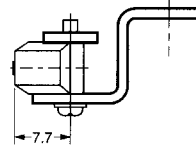
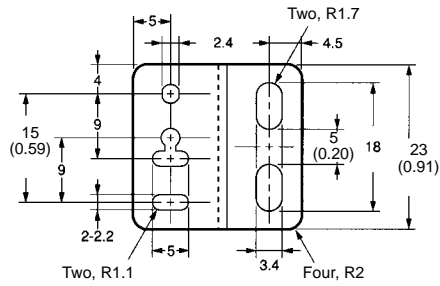

**E39-L118 (shown with E3T-ST1□)**

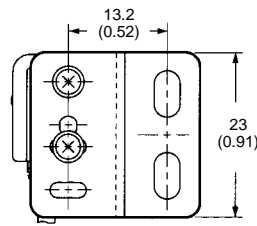
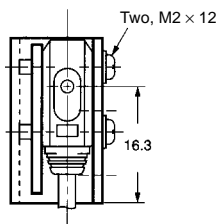
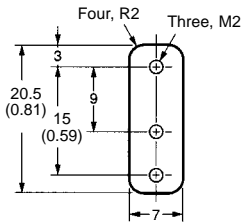

## Mounting Brackets for E3T-FT1□/E3T-FD1□N

### E39-L119

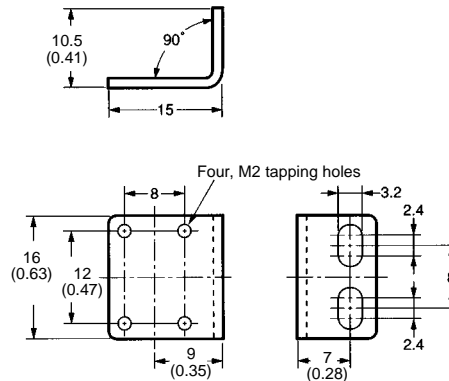
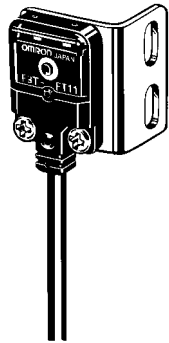

### E39-L119 shown with E3T-F□1□

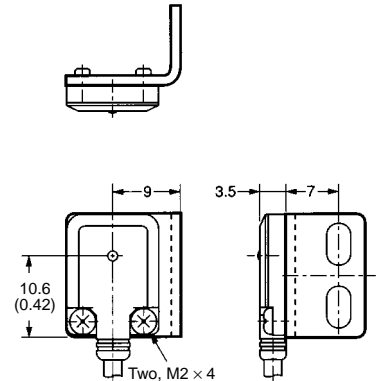

### E39-L120

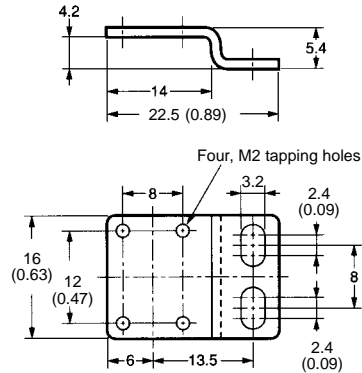
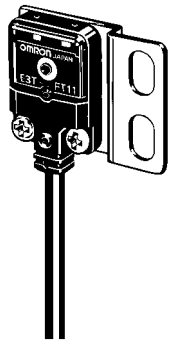

### E39-L120 shown with E3T-F□1□

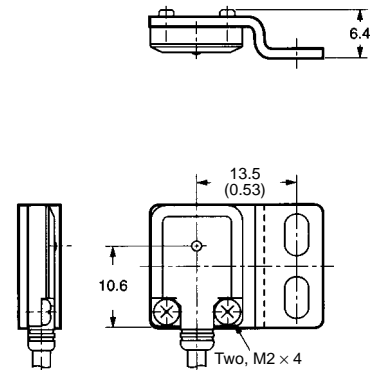

## Precautions



### Caution

Avoid damage to the E3T: NEVER apply AC power to the E3T.

### ■ AVOID DAMAGE TO THE E3T

- Do not exceed the rated voltage on the E3T.
- Do not short-circuit the load connected to the E3T.
- When supplying power to the E3T, make sure that the polarity of the power is correct.

### ■ OPERATING ENVIRONMENT

To avoid malfunction, DO NOT install the E3T in the following environments:

- Locations where the E3T is exposed to intense sunlight.
- Locations with high humidity and where condensation may result.
- Locations with corrosive gas.
- Locations with vibration or shock affecting the E3T.

### ■ HIGH-TENSION LINES

To avoid Sensor damage or malfunctioning due to induction noise, do not place the power supply lines of the Photoelectric Sensor within the same conduit as power lines or high-tension lines.

### ■ CABLE

The cable can be extended up to 100 m provided that cable thickness does not exceed the 0.3 mm<sup>2</sup> maximum.

### ■ POWER SUPPLIES

If a switching regulator is connected to the E3T, you must ground the FG (frame ground) and G (ground) terminals, or the switching noise of the switching regulator may cause the E3T to malfunction.

## ■ WATER RESISTANCE

- Do not use the E3T underwater, outdoors, or in the rain.
- Use M2 screws and washers to mount the E3T. When mounting the E3T, NEVER strike the E3T with a hammer, or the E3T will lose its watertight properties.

## ■ LOAD SHORT-CIRCUIT PROTECTION

The E3T incorporates a load short-circuit protection function. If the load short-circuits, the output of the E3T will be turned OFF. Recheck the wiring and turn on the E3T again to reset the load short-circuit protection function. The load short-circuit protection function will work if there is a current flow that is 2.4 times larger than the rated load current.

When using an inductance load, be sure that the inrush current will not exceed 2.4 times larger than the rated current.

## ■ CLEANING

DO NOT apply paint thinner when cleaning the E3T. Paint thinner will damage the casing of the E3T.

## ■ INDICATORS

The following graphs indicate the status of each operation level.

Be sure to use the E3T within the stable operating range.

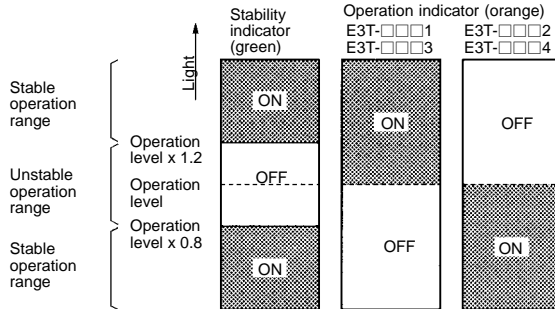

Note: When the E3T's operation level is set to the stable operation range, the E3T will be in its most reliable operation without being influenced by temperature, voltage fluctuation, dust, or mounting changes.

## ■ TURNING ON POWER SUPPLY

- The E3T will be ready for sensing 100 ms after the power is turned ON.
- If the E3T is connected to a power source different from one for loads, be sure to turn ON the power supply to the E3T first.

**NOTE: DIMENSIONS SHOWN ARE IN MILLIMETERS. To convert millimeters to inches divide by 25.4.**

# OMRON®

OMRON ELECTRONICS, INC.

One East Commerce Drive  
Schaumburg, IL 60173

1-800-55-OMRON

OMRON CANADA, INC.

885 Milner Avenue  
Scarborough, Ontario M1B 5V8

416-286-6465