

SD

D'Sub connectors - Stamped and Formed Contacts

RIGHT ANGLE BOARD MOUNT CONNECTORS

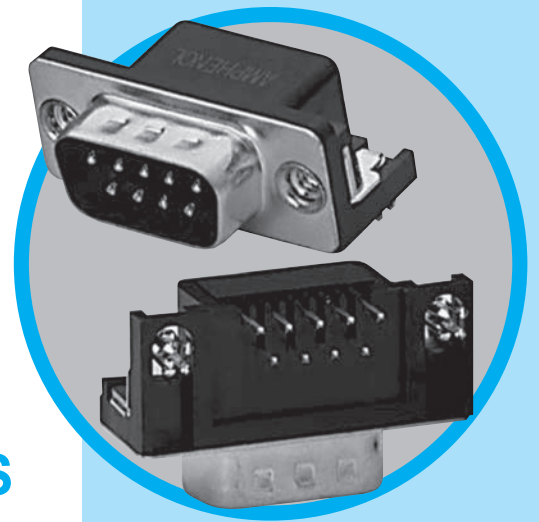

CHARACTERISTICS

Specifications

- Connectors according to: MIL C24308
- UL File: E149426

Materials and Platings	
Shells	Steel, tin over nickel plating
Insulator	Glass-filled thermoplastic, UL 94V-0
Contacts	Brass, selected gold in mating area; 2.54µm (100 µ") min. tin on termination area over 1.27µm (50µ") min. nickel
Rear insert	Brass, 2.54µm (100µ") min. nickel plated
Boardlock	Brass, 2.54µm (100µ") min. nickel plated
Screwlock	Brass, 2.54µm (100µ") min. nickel plated

Electrical Data	
Current rating	3A
Voltage rating	250V AC/ rms 50Hz
Withstanding voltage	1000V AC/rms 50Hz for one minute
Insulation resistance	1000MΩ at 500V DC
Contact resistance	20mΩ max

Climatic Data	
Operating temperature	-55°C to +125°C
Salt spray	24 hours

Mechanical Data				
Single contact insertion force	0.54kg (1.19lb) max			
Single contact withdrawal force	0.06kg (0.13lb) min			
Mating and unmating force				
Unit: kg (lb)				
	A4 Style		1A Style	
No. of Cts	Mate (max)	Unmate (min)	Mate (max)	Unmate (min)
9	3.05 (6.74)	0.36 (0.79)	4.6 (10.17)	0.4 (0.88)
15	5.09 (11.24)	0.46 (1.01)	7.7 (17.02)	0.5 (1.10)
25	8.44 (18.66)	0.81 (1.8)	12.7 (28.07)	0.8 (1.77)
37	12.51 (27.65)	1.1 (2.47)	17.7 (39.12)	1.2 (2.65)
Standard plating thickness				
<ul style="list-style-type: none"> • gold flash • 0.381µm (15µ") gold • 0.76 µm (30µ") gold 				

DESCRIPTION

The Amphenol "SD" series features precision formed contacts and boardlocks.

This series gives you Amphenol's high standards of quality and reliability to meet all of your commercial requirements.

*Economical
right angle PCB
mount
connectors*

APPLICATIONS

- Industrial
- Telecom
- Any industry standard I/O connections



Amphenol

SD / E7

A4 style (MIL Footprint)

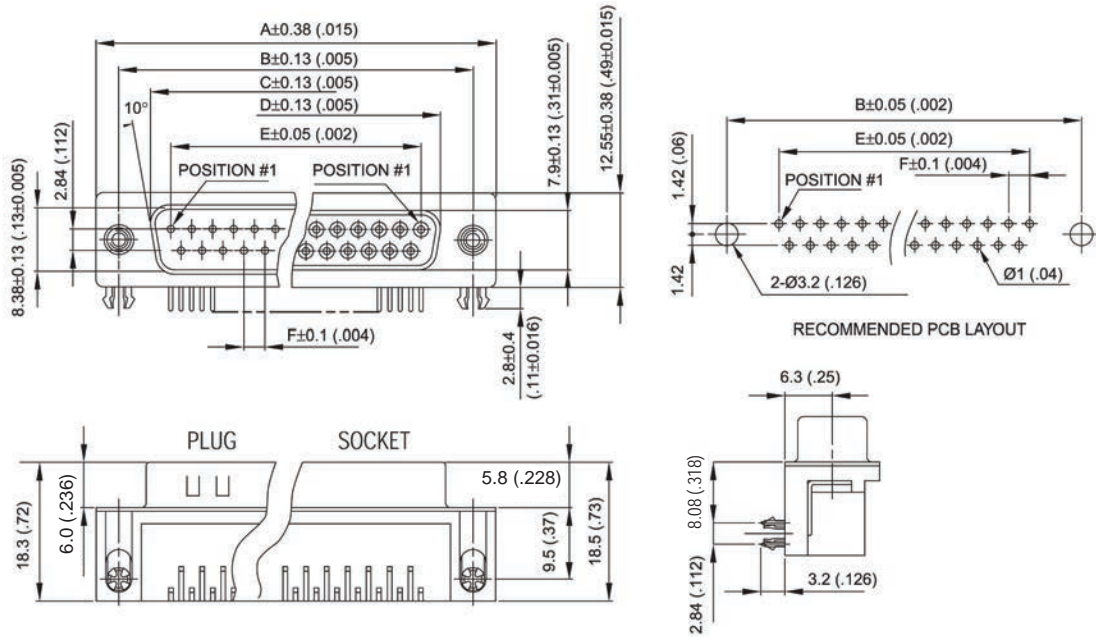

Nb OF CONTACTS	DIMENSIONS mm (inch)					
	A	B	C	D	E	F
9	30.84 (1.21)	24.99 (.98)	16.92 (.67)	16.24 (.64)	11.09 (.44)	2.77 (.109)
15	39.14 (1.54)	33.32 (1.31)	25.25 (.99)	24.56 (.97)	19.39 (.76)	2.77 (.109)
25	53.04 (2.09)	47.04 (1.85)	38.96 (1.53)	38.38 (1.51)	33.24 (1.31)	2.77 (.109)
37	69.32 (2.73)	63.50 (2.50)	55.42 (2.18)	54.76 (2.16)	49.86 (1.96)	2.77 (.109)

1A / 1B style (European Footprint)

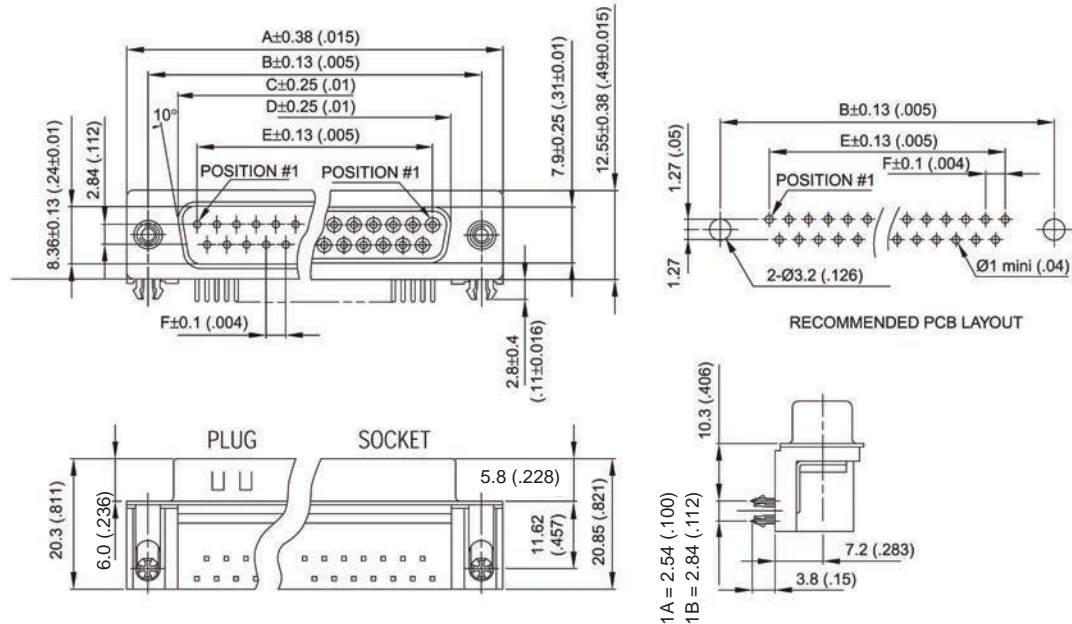

Nb OF CONTACTS	DIMENSIONS mm (inch)					
	A	B	C	D	E	F
9	30.84 (1.21)	24.99 (.98)	16.92 (.67)	16.24 (.64)	11.96 (.43)	2.77 (.109)
15	39.1 (1.54)	33.32 (1.31)	25.25 (.99)	24.66 (.97)	19.18 (.755)	2.77 (.109)
25	53.09 (2.09)	47.04 (1.85)	38.96 (1.53)	38.38 (1.51)	33.24 (1.31)	2.77 (.109)
37	69.4 (2.73)	63.50 (2.50)	55.42 (2.18)	54.84 (2.16)	49.86 (1.96)	2.77 (.109)

Panel mounting option

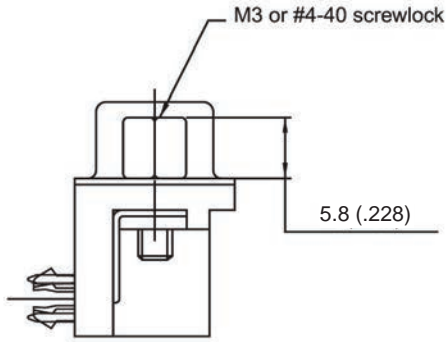

Front Female Screwlock
4F / 3F

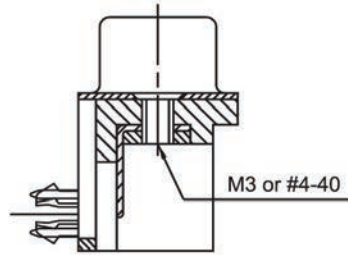

Threaded Rear Insert
4R / 3R

Example: L717 SD E 09 P A4 CH 4F
L77 SD B 25 S 1A CH 4R

How to order

L	...	SD	CH	...	C309
RoHS Compliant									
gold flash	77: tinned shell for receptable 717: tinned shell + dimples for plug								plating option: valid only for 0.76µm (30µ") part numbers to be written as follow: or 77 SD.....C309 717 SD.....C309
0.4µm (15µ")	177: tinned shell for receptable 777: tinned shell + dimples for plug								mounting options 4F = front screwlock 4-40 3F = front screwlock M3 4R = rear insert 4-40 3R = rear insert M3
shell size E, A, B, C									PCB locking type grounding tabs + board locks
configuration 09, 15, 25, 37									footprint 1A = European (10.3mm, 2.54mm pitch) 1B = European (10.3mm, 2.84mm pitch) A4 = MIL (8.08mm)
contact type P = plug S = socket									

For special request, please consult factory

