

# RPL-10 Series / Power Module

10Amp / 4-16VDC / 29 Pad LGA-M Package

## FEATURES

- High power density (10A in 7x7x4.4mm)
- Operating temperature of -40°C to +90°C at full load
- High efficiency 94%
- Wide 4-16VDC input voltage
- SCP, OCP, and UVLO protection
- Programmable 0.6-5.5V output
- Selectable operating frequency (600kHz - 1MHz)
- Constant on-time for fast transient load response
- Pulse skipping for optimal light load performance
- 3 year warranty



Dimensions (LxWxH): 7.0 x 7.0 x 4.4mm (0.276 x 0.276 x 0.173inch)  
0.1g (0.0002 lbs)

## APPLICATIONS

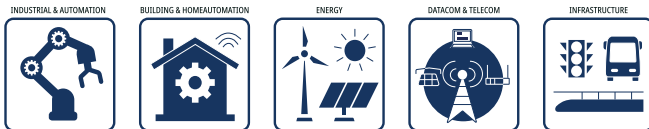

## SAFETY & EMC



## DESCRIPTION

The RPL-10 is a 10A buck converter with integrated inductor in a compact 7mm x 7mm x 4.4mm thermally-enhanced LGA package. The input range is from 4.0 to 16VDC, allowing both 5V and 12V supply rails to be used. The output voltage can be set with two resistors in the range from 0.6V up to 5.5V. The output is fully protected against continuous short-circuit, overload, under-voltage or over-temperature faults. A PG output and EN input allow easy power sequencing. Its high output current capability, small size, light load pulse skipping and fast transient regulation make the RPL-10 ideal for FPGAs, imaging systems, distributed power architectures, portable equipment in telecom as well as industrial applications.

## SELECTION GUIDE

| Part Number | Input Voltage Range [VDC] | Output Voltage Range [VDC] | Output Current max. [A] | Efficiency <sup>(1)</sup> typ. [%] |
|-------------|---------------------------|----------------------------|-------------------------|------------------------------------|
| RPL-10      | 4 - 16                    | 0.6 - 5.5                  | 10                      | 94                                 |

Note1: Efficiency is tested at  $V_{IN}= 12VDC$ ,  $V_{OUT}= 5VDC$  full load at +25°C ambient

## MODEL NUMBERING

**RPL-10-**  
 Output Current   Packaging <sup>(2)</sup>

Note2: Add suffix "-T" for tray packaging  
Add suffix "-CT" for bag packaging (refer to „Packaging Information“)

### ABSOLUTE MAXIMUM RATINGS

| Parameter                                      | Symbol   | Condition                | Min.    | Typ. | Max.   |
|--|----------|--------------------------|---------|------|--------|
| Absolute Maximum Voltage                       | $V_{IN}$ |                          | -0.3VDC |      | 18VDC  |
|  | $V_{SW}$ |                          | -0.3VDC |      | 0.3VDC |
|  | $V_{CC}$ |                          |         |      | 4.5VDC |
|  | others   |                          | -0.3VDC |      | 4.3VDC |
| Maximum Continuous Power Losses <sup>(3)</sup> |          | $T_{AMB} = +25^{\circ}C$ |         |      | 9W     |
| Junction Temperature                           | $T_J$    |                          |         |      | +170°C |
| Lead Temperature                               |          |                          |         |      | +260°C |

Note3: Exceeding maximum allowable power dissipation causes device to enter thermal shutdown which protects device from permanent damage.

Note4: Stressed beyond those listed under absolute maximum ratings can cause permanent damage to the device.

### BASIC CHARACTERISTICS (measured @ $T_{AMB} = 25^{\circ}C$ , nom. $V_{IN}$ , full load and after warm-up unless otherwise stated)

| Parameter                  | Symbol    | Condition                              | Min.    | Typ.    | Max.    |
|----------------------------|-----------|--|---------|---------|---------|
| Input Voltage Range        | $V_{IN}$  | refer to „Safe Operating Area“         | 4VDC    |         | 16VDC   |
| Vin-Vsw                    |           |  | -0.3VDC |         | 0.3VDC  |
| Vsw                        |           |  | -0.3VDC |         | 0.3VDC  |
| Under Voltage Lockout UVLO |           | rising, $V_{CC} = 3.3VDC$              | 2.1VDC  | 2.4VDC  | 2.7VDC  |
|                            |           | falling, $V_{CC} = 3.3VDC$             | 1.55VDC | 1.85VDC | 2.15VDC |
| Quiescent Current          | $I_Q$     | $V_{CTRL} = 2VDC, V_{FB} = 0.62VDC$    |         | 650µA   | 850µA   |
| Output Voltage Range       | $V_{OUT}$ | refer to „Safe Operating Area“         | 0.6VDC  |         | 5.5VDC  |
| Standby Current            | $I_S$     | $V_{CTRL} = 0VDC$                      |         | 10µA    |         |
| Feedback Voltage           | $V_{FB}$  | $T_J = -40^{\circ}C$ to $125^{\circ}C$ | 594mV   | 600mV   | 606mV   |
|                            |           | $T_J = 0^{\circ}C$ to $70^{\circ}C$    | 597mV   | 600mV   | 603mV   |
| Minimum On Time            |           | $V_{FB} = 500mV$                       |         |         | 50ns    |
| Minimum Off Time           |           | $V_{FB} = 500mV$                       |         |         | 180ns   |
| Soft Start                 |           | $C_{TRACK} = 100nF, T_J = 25^{\circ}C$ |         | 1.6ms   |         |

### Safe Operating Area

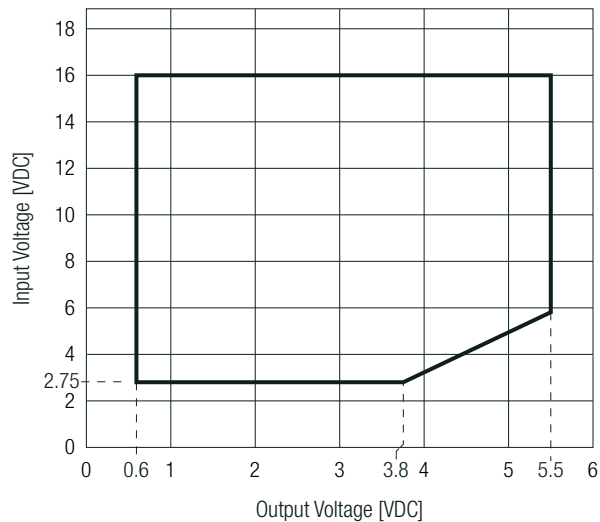

### CTRL OPERATING CONDITIONS

| Parameter                 | Symbol             | Condition | Min.    | Typ.    | Max.                |
|---------------------------|--------------------|-----------|---------|---------|---------------------|
| ON/OFF CTRL               |                    | DC-DC ON  |         |         | $V_{CTRL} > 1.6VDC$ |
|                           |                    | DC-DC OFF |         |         | $V_{CTRL} < 1.3VDC$ |
| CTRL Voltage              |                    |           |         | 3.6VDC  | 4.3VDC              |
| CTRL Rising Threshold     | $V_{CTRL\_RISING}$ |           | 1.19VDC | 1.22VDC | 1.25VDC             |
| CTRL Hysteresis Threshold |                    |           | 160mV   | 200mV   | 280mV               |
| CTRL Input Current        | $I_{CTRL}$         |           |         |         | 50µA                |

### CTRL OPERATING CONDITIONS

#### Typical Application

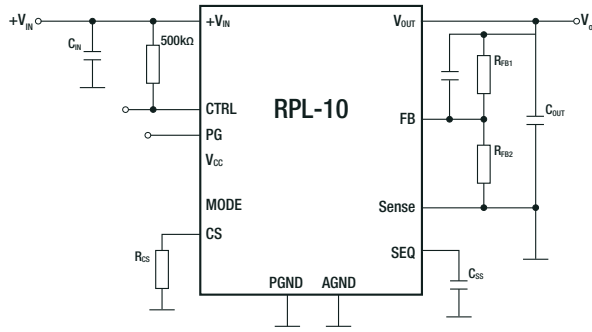

### POWER GOOD OPERATING CONDITIONS

| Parameter               | Symbol                   | Condition   | Min.                      | Typ.                      | Max.                      |
|-------------------------|--------------------------|---|---------------------------|---------------------------|---------------------------|
| high Threshold          | PG <sub>HIGH_RISE</sub>  | Pull FB from low to high                                      | 89.5% of V <sub>REF</sub> | 92.5% of V <sub>REF</sub> | 95.5% of V <sub>REF</sub> |
|                         | PG <sub>HIGH_FALL</sub>  | Pull FB from high to low                                      | 92% of V <sub>REF</sub>   | 101% of V <sub>REF</sub>  | 108% of V <sub>REF</sub>  |
| low Threshold           | PG <sub>LOW_RISE</sub>   | Pull FB from low to high                                      | 113% of V <sub>REF</sub>  | 116% of V <sub>REF</sub>  | 119% of V <sub>REF</sub>  |
|                         | PG <sub>LOW_FALL</sub>   | Pull FB from high to low                                      | 77% of V <sub>REF</sub>   | 80% of V <sub>REF</sub>   | 83% of V <sub>REF</sub>   |
| Rise Delay              |                          | T <sub>J</sub> = 25°C   |                           | 0.9ms                     |                           |
| Sink Current Capability | V <sub>PG</sub>          | I <sub>PG</sub> = 10mA  |                           |                           | 0.4VDC                    |
| Leakage Current         | I <sub>PG_LEAK</sub>     | V <sub>PG</sub> = 3.3VDC                                      |                           |                           | 3μA                       |
| Low Output Voltage      | V <sub>OUT_LOW_100</sub> | V <sub>IN</sub> = 0VDC, pull PG to 3.3VDC with 100kΩ resistor |                           | 650mV                     | 850mV                     |
|                         | V <sub>OUT_LOW_10</sub>  | V <sub>IN</sub> = 0VDC, pull PG to 3.3VDC with 10kΩ resistor  |                           | 800mV                     | 1000mV                    |

Note5: The PG pin is an open-drain signal. A 100kΩ pull-up resistor connected to V<sub>CC</sub> indicates high if V<sub>OUT</sub> is within regulation.

### SWITCHING CHARACTERISTICS

| Parameter           | Symbol          | Condition              | Min.   | Typ.    | Max.    |
|---------------------|-----------------|------------------------|--------|---------|---------|
| Switching Frequency | f <sub>sw</sub> | mode = V <sub>CC</sub> | 480kHz | 600kHz  | 720kHz  |
|                     |                 | mode = open            | 680kHz | 800kHz  | 920kHz  |
|                     |                 | mode = 243kΩ to GND    | 850kHz | 1000kHz | 1150kHz |

### VCC CONDITIONS

| Parameter                  | Symbol | Condition              | Min.    | Typ.    | Max.    |
|----------------------------|--------|------------------------|---------|---------|---------|
| VCC Regulator              |        |                        | 2.88VDC | 3VDC    | 3.12VDC |
| VCC Load Regulation        |        | I <sub>CC</sub> = 25mA |         | 0.5%    |         |
| VCC UVLO Rising Threshold  |        |                        | 2.65VDC | 2.81VDC | 2.95VDC |
| VCC UVLO Falling Threshold |        |                        | 2.35VDC | 2.5VDC  | 2.65VDC |
| External VCC bias          |        |                        | 3.12VDC |         | 3.6VDC  |

### OUTPUT VOLTAGE SETTING

The external resistor divider is used to set the output voltage. First, choose a value for R<sub>FB2</sub>. R<sub>FB2</sub> should be chosen reasonably, a small R<sub>FB2</sub> will lead to considerable quiescent current loss while too large R<sub>FB2</sub> makes the FB noise sensitive. It is recommended to choose a value between 100kΩ-500kΩ for R<sub>FB2</sub>. Typically, set the current through R<sub>FB2</sub> between 1-5μA will make a good balance between system stability and also the no load loss. Then R<sub>FB1</sub> is determined as followed. The values for trim resistors shown in trim tables below are according to standard E96 values; therefore, the specified voltage may slightly vary.

#### Feedback Network

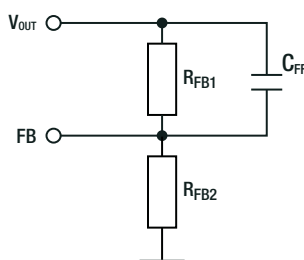

#### Calculation:

$$R_{FB2} = \frac{V_{ref}}{(V_{OUT} - V_{ref})} \times R_{FB1}$$

#### Practical example with V<sub>OUT</sub> = 1.8VDC

$$R_{FB2} = \frac{0.6V}{(1.8V - 0.6V)} \times 2k\Omega = 1k\Omega$$

Table below lists recommended resistor values for common V<sub>OUT</sub>:

| V <sub>OUTset</sub> [VDC] | C <sub>FF</sub> [nF] | R <sub>FB1</sub> [Ω] | R <sub>FB2</sub> [Ω] |
|---------------------------|----------------------|----------------------|----------------------|
| 1                         | 4.7                  | 2k                   | 3k                   |
| 1.2                       |                      |                      | 2k                   |
| 1.8                       |                      | 1k                   |                      |
| 3.3                       |                      | 10k2                 | 2k26                 |
| 5.5                       |                      | 7k5                  | 1k02                 |

# RPL-10 Series / Power Module

10Amp / 4-16VDC / 29 Pad LGA-M Package



## THERMAL OPERATING CONDITIONS

| Parameter                         | Symbol      | Condition                   | Min.  | Typ.    | Max.   |
|-----------------------------------|-------------|-----------------------------|-------|---------|--------|
| Operating Junction Temperature    | $T_J$       | refer to „Thermal Derating“ | -40°C |         | +125°C |
| Thermal Resistance <sup>(6)</sup> | $R_{th,JA}$ | junction to ambient         |       | 16.2K/W |        |
|                                   | $R_{th,JC}$ | junction to case            |       | 5.1K/W  |        |

Note6: Test PCB= 6.4 x 6.4cm double sided PCB with 20oz copper, natural convection

## ENVIRONMENTAL

| Parameter                        | Condition | Value   |
|----------------------------------|-----------|---------|
| Moisture Sensitivity Level (MSL) |           | Level 3 |

## PROTECTIONS

| Parameter                            | Condition              | Value                 |            |
|--------------------------------------|------------------------|-----------------------|------------|
| Short Circuit Protection (SCP)       |                        | hiccup, auto recovery |            |
| Over Current Protection (OCP)        |                        | hiccup, auto recovery |            |
| Output Overvoltage Protection Rising | % of $V_{REF}$         | 113% min. - 119% max. |            |
| Thermal Shutdown                     | restart after cooldown | junction temperature  | 160°C typ. |
|                                      |                        | hysteresis            | 30°C typ.  |

## TYPICAL PERFORMANCE CHARACTERISTICS

1.2Vout

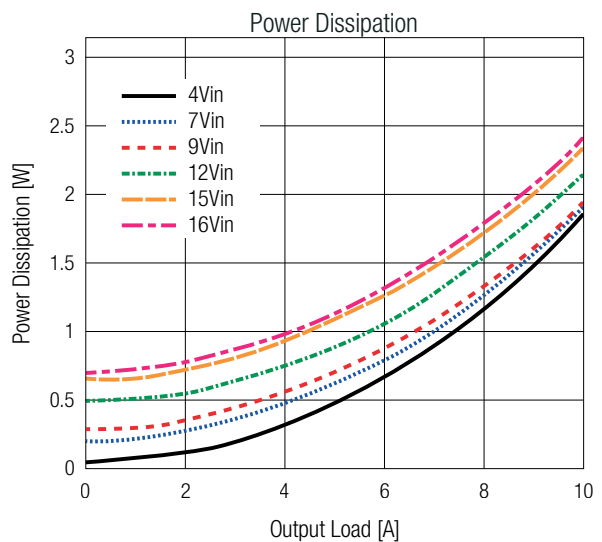
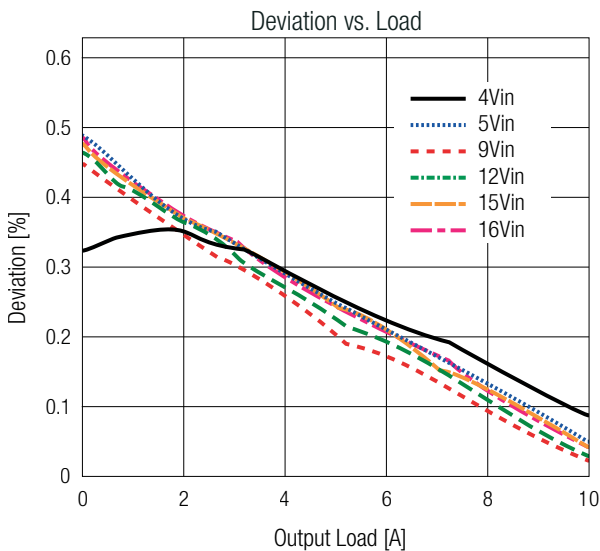
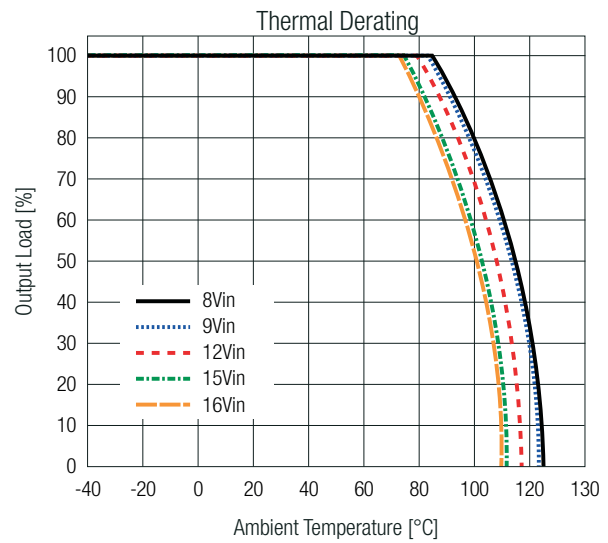
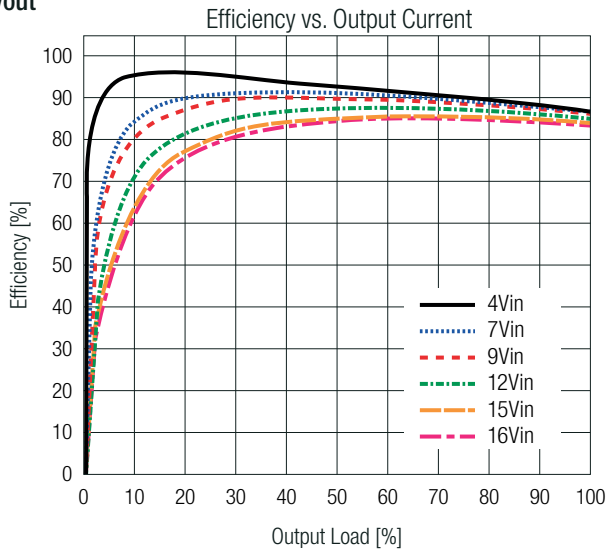

### TYPICAL PERFORMANCE CHARACTERISTICS

5Vout

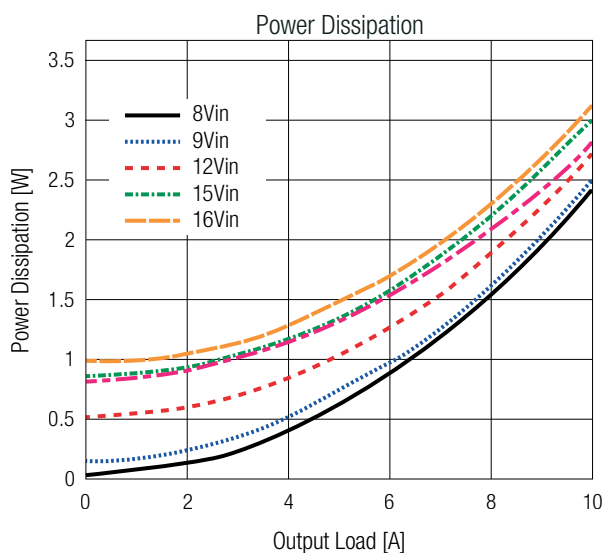
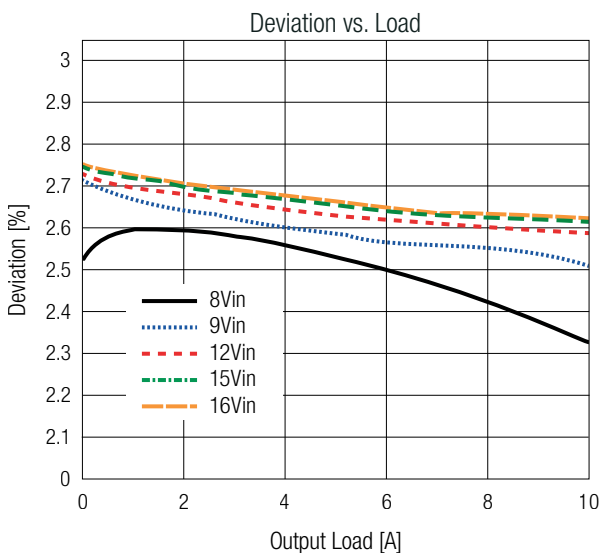
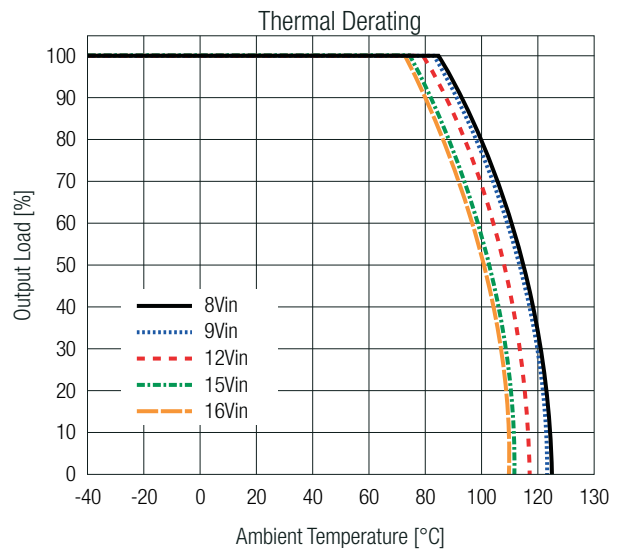
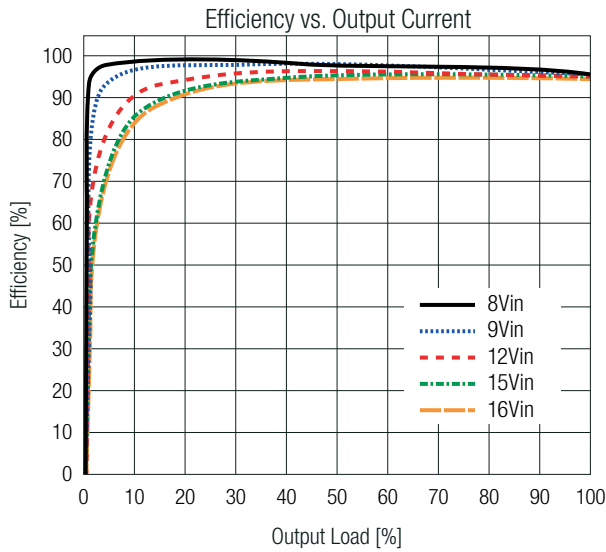

### SAFETY & CERTIFICATIONS

| Certificate Type (Safety) | Report Number | Standard                    |
|---------------------------|---------------|-----------------------------|
| RoHS2                     |               | RoHS 2011/65EU + AM2015/863 |

### DIMENSION & PHYSICAL CHARACTERISTICS

| Parameter         | Type | Value  |
|-------------------|------|--|
| Material          | case | plastic  |
| Dimension (LxWxH) |      | 7.0 x 7.0 x 4.4mm<br>0.276 x 0.276 x 0.173inch |
| Weight            |      | 0.1g typ.<br>0.0002 lbs                        |

### DIMENSION & PHYSICAL CHARACTERISTICS

Dimension Drawing (mm)

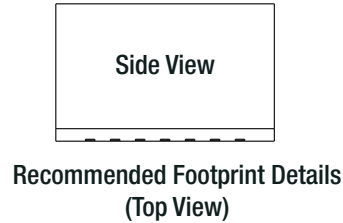
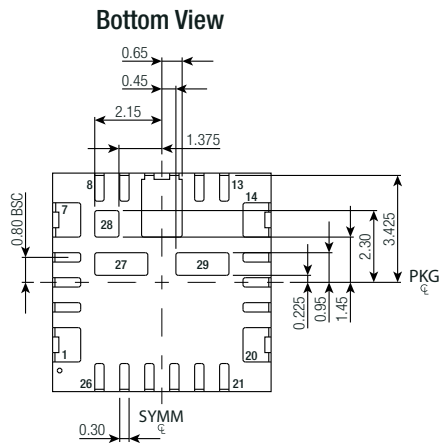
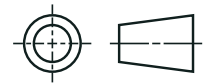
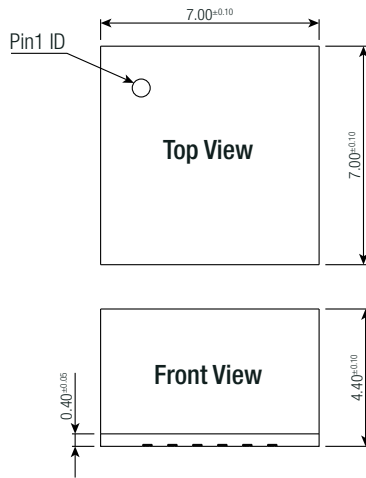

Tolerances:  
 x.x= ±0.1mm  
 x.xx= ±0.05mm

### Pad Information

| Pad #                  | Function         | Description  |
|------------------------|------------------|--|
| 1, 2, 6, 7             | V <sub>OUT</sub> | Output Voltage   |
| 3                      | CTRL/UVLO        | CTRL pin. Do not float.  |
| 4                      | PG               | Power good output.   |
| 5, 8, 9, 27, 28        | +V <sub>IN</sub> | Input supply voltage. Connect using wide PCB traces.   |
| 10, 11, 12             | PGND             | System ground. Use wide PCB traces.  |
| 13                     | V <sub>CC</sub>  | Internal 3V low-dropout (LDO) output.  |
| 14, 15, 16, 19, 20, 29 | SW               | Connect to floating copper plane for improved thermal performance. Thermal pad must be floating.   |
| 17                     | NC               | Do not connect.  |
| 18, 21                 | AGND             | Analog ground. AGND pin is the control circuit reference point.  |
| 22                     | CS               | Current limit setpoint.  |
| 23                     | MODE             | Operation mode selection. Configure the MODE pin to the operating switching frequency (f <sub>sw</sub> ).  |
| 24                     | SEQ              | External tracking voltage/soft start capacitor input. V <sub>OUT</sub> tracks the SEQ pin input signal. In the range of 0.6-1.4V. Decouple with 27nF MLCC capacitor between this pin and Sense, or use a larger value to increase the soft-start time. |
| 25                     | Sense            | Connect to negative voltage sense point or to AGND if not used.  |
| 26                     | FB               | FB input. Used to set output voltage between 0.6 and 5.5V.   |

# RPL-10 Series / Power Module

10Amp / 4-16VDC / 29 Pad LGA-M Package



## PACKAGING INFORMATION

| Parameter                   | Type                             | Value                  |
|-----------------------------|----------------------------------|------------------------|
| Packaging Dimension (LxWxH) | Suffix -T: tray                  | 392 x 160 x 98mm       |
|                             |                                  | 15.43 x 6.3 x 3.86inch |
|                             | Suffix -CT: moisture barrier bag | 100 x 100 x 30mm       |
| Packaging Quantity          | Suffix -T: tray                  | 260pcs                 |
|                             | Suffix -CT: moisture barrier bag | 10pcs                  |
| Storage Temperature Range   |                                  | -65°C to +150°C        |
| Storage Humidity            | non-condensing                   | 60% RH max.            |

The product information and specifications may be subject to changes even without prior written notice. The product has been designed for various applications; its suitability lies in the responsibility of each customer. The products are not authorized for use in safety-critical applications without RECOM's explicit written consent. A safety-critical application is an application where a failure may reasonably be expected to endanger or cause loss of life, inflict bodily harm or damage property. The applicant shall indemnify and hold harmless RECOM, its affiliated companies and its representatives against any damage claims in connection with the unauthorized use of RECOM products in such safety-critical applications.