

Final datasheet

CoolSiC™ 1200 V SiC MOSFET G2 : Silicon Carbide MOSFET

Features

- $V_{DSS} = 1200\text{ V}$ at $T_{vj} = 25^\circ\text{C}$
- $I_{DC} = 102\text{ A}$ at $T_C = 100^\circ\text{C}$
- $R_{DS(on)} = 12.2\text{ m}\Omega$ at $V_{GS} = 18\text{ V}$, $T_{vj} = 25^\circ\text{C}$
- Very low switching losses
- Overload operation up to $T_{vj} = 200^\circ\text{C}$
- Short circuit withstand time $2\ \mu\text{s}$
- Benchmark gate threshold voltage, $V_{GS(th)} = 4.2\text{ V}$
- Robust against parasitic turn on, 0 V turn-off gate voltage can be applied
- Robust body diode for hard commutation
- .XT interconnection technology for best-in-class thermal performance
- Suitable Infineon gate drivers can be found under <https://www.infineon.com/gdfinder>

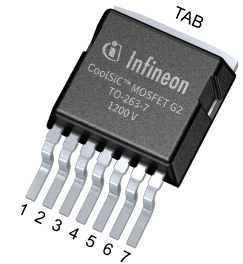

- Halogen-free
- Green
- Lead-free
- RoHS

Potential applications

- EV-Charging
- Online UPS/Industrial UPS
- Solar power optimizer
- String inverter
- General purpose drives (GPD)

Product validation

- Qualified for industrial applications according to the relevant tests of JEDEC47/20/22

Description

Pin definition:

- Pin 1 - Gate
- Pin 2 - Kelvin sense contact
- Pin 3...7 - Source
- Tab - Drain

Note: the source and sense pins are not exchangeable, their exchange might lead to malfunction (only for 4pin, TO263-7L)

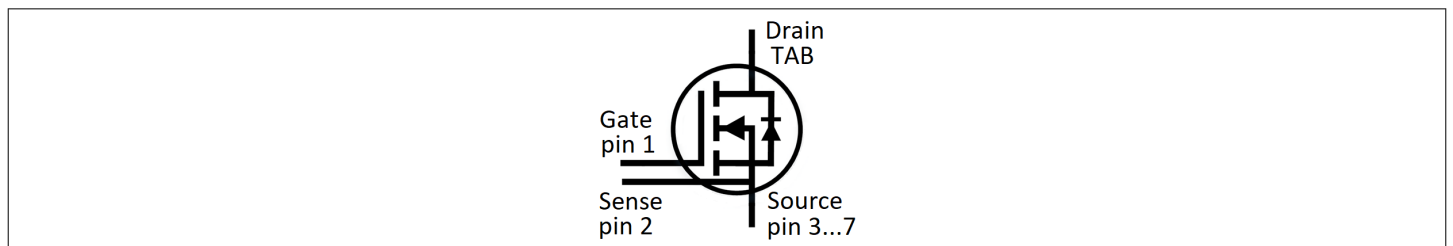

Type	Package	Marking
IMBG120R012M2H	PG-TO263-7-HV-ND5.8	12M2H012

Table of contents

	Description	1
	Features	1
	Potential applications	1
	Product validation	1
	Table of contents	2
1	Package	3
2	MOSFET	3
3	Body diode (MOSFET)	6
4	Characteristics diagrams	8
5	Package outlines	14
6	Testing conditions	15
	Revision history	16
	Disclaimer	17

1 Package

Table 1 Characteristic values

Parameter	Symbol	Note or test condition	Values			Unit
			Min.	Typ.	Max.	
Storage temperature	T_{stg}		-55		150	°C
Soldering temperature	T_{sold}	reflow soldering (MSL1 according to JEDEC J-STA-020)			260	°C
Thermal resistance, junction-ambient	$R_{th(j-a)}$				62	K/W
MOSFET/body diode thermal resistance, junction-case	$R_{th(j-c)}$			0.19	0.25	K/W

2 MOSFET

Table 2 Maximum rated values

Parameter	Symbol	Note or test condition	Values	Unit	
Drain-source voltage	V_{DSS}	$T_{vj} \geq 25 \text{ °C}$	1200	V	
Continuous DC drain current for $R_{th(j-c,max)}$, limited by $T_{vj(max)}$	I_{DDC}	$V_{GS} = 18 \text{ V}$	$T_c = 25 \text{ °C}$	144	A
			$T_c = 100 \text{ °C}$	102	
Peak drain current, t_p limited by $T_{vj(max)}$ ¹⁾	I_{DM}	$V_{GS} = 18 \text{ V}$	306	A	
Gate-source voltage, max. transient voltage	V_{GS}	$t_p \leq 0.5 \text{ }\mu\text{s}$, $D < 0.01$	-10...23	V	
Gate-source voltage, max. static voltage	V_{GS}		-7...20	V	
Avalanche energy, single pulse	E_{AS}	$I_D = 56.7 \text{ A}$, $V_{DD} = 50 \text{ V}$, $L = 0.4 \text{ mH}$	712	mJ	
Avalanche energy, repetitive	E_{AR}	$I_D = 56.7 \text{ A}$, $V_{DD} = 50 \text{ V}$, $L = 2.2 \text{ mH}$	3.56	mJ	
Short-circuit withstand time	t_{SC}	$V_{DD} \leq 800 \text{ V}$, $V_{DS,peak} < 1200 \text{ V}$, $V_{GS(on)} = 15 \text{ V}$, $T_{vj(start)} = 25 \text{ °C}$	2	μs	
Power dissipation, limited by $T_{vj(max)}$	P_{tot}		$T_c = 25 \text{ °C}$	600	W
			$T_c = 100 \text{ °C}$	300	

1) verified by design.

Table 3 Recommended values

Parameter	Symbol	Note or test condition	Values	Unit
Recommended turn-on gate voltage	$V_{GS(on)}$		15...18	V
Recommended turn-off gate voltage	$V_{GS(off)}$		-5...0	V

Table 4 Characteristic values

Parameter	Symbol	Note or test condition	Values			Unit
			Min.	Typ.	Max.	
Drain-source on-state resistance	$R_{DS(on)}$	$I_D = 56.7 \text{ A}$	$T_{vj} = 25 \text{ °C}$, $V_{GS(on)} = 18 \text{ V}$	12.2		mΩ
			$T_{vj} = 150 \text{ °C}$, $V_{GS(on)} = 18 \text{ V}$	25	33	
			$T_{vj} = 175 \text{ °C}$, $V_{GS(on)} = 18 \text{ V}$	28.9		
			$T_{vj} = 25 \text{ °C}$, $V_{GS(on)} = 15 \text{ V}$	15.3		
Gate-source threshold voltage	$V_{GS(th)}$	$I_D = 17.8 \text{ mA}$, $V_{DS} = V_{GS}$ (tested after 1 ms pulse at $V_{GS} = 20 \text{ V}$)	$T_{vj} = 25 \text{ °C}$	3.5	4.2	V
			$T_{vj} = 175 \text{ °C}$		3.2	
Zero gate-voltage drain current	I_{DSS}	$V_{DS} = 1200 \text{ V}$, $V_{GS} = 0 \text{ V}$	$T_{vj} = 25 \text{ °C}$		490	μA
			$T_{vj} = 175 \text{ °C}$		8.4	
Gate leakage current	I_{GSS}	$V_{DS} = 0 \text{ V}$	$V_{GS} = 23 \text{ V}$		120	nA
			$V_{GS} = -10 \text{ V}$		-120	
Forward transconductance	g_{fs}	$I_D = 56.7 \text{ A}$, $V_{DS} = 20 \text{ V}$		26.1		S
Internal gate resistance	$R_{G,int}$	$f = 1 \text{ MHz}$, $V_{AC} = 25 \text{ mV}$		4		Ω
Input capacitance	C_{iss}	$V_{DD} = 800 \text{ V}$, $V_{GS} = 0 \text{ V}$, $f = 100 \text{ kHz}$, $V_{AC} = 25 \text{ mV}$		4050		pF
Output capacitance	C_{oss}	$V_{DD} = 800 \text{ V}$, $V_{GS} = 0 \text{ V}$, $f = 100 \text{ kHz}$, $V_{AC} = 25 \text{ mV}$		176		pF
Reverse transfer capacitance	C_{rss}	$V_{DD} = 800 \text{ V}$, $V_{GS} = 0 \text{ V}$, $f = 100 \text{ kHz}$, $V_{AC} = 25 \text{ mV}$		15		pF
C_{oss} stored energy	E_{oss}	$V_{DD} = 800 \text{ V}$, $V_{GS} = 0 \text{ V}$, $f = 100 \text{ kHz}$, $V_{AC} = 25 \text{ mV}$		74		μJ
Output charge	Q_{oss}	Calculated by $C_{oss}(f)V_{DS}$ @100 kHz		275.3		nC
Effective output capacitance, energy related	$C_{o(er)}$	$V_{DD} = 0...800 \text{ V}$, $V_{GS} = 0 \text{ V}$		231.3		pF
Effective output capacitance, time related	$C_{o(tr)}$	$I_C = \text{constant}$, $V_{DD} = 0...800 \text{ V}$, $V_{GS} = 0 \text{ V}$		344.1		pF
Total gate charge	Q_G	$V_{DD} = 800 \text{ V}$, $I_D = 56.7 \text{ A}$, $V_{GS} = -2/18 \text{ V}$, turn-on pulse		124		nC

(table continues...)

Table 4 (continued) Characteristic values

Parameter	Symbol	Note or test condition	Values			Unit
			Min.	Typ.	Max.	
Plateau gate charge	$Q_{GS(pl)}$	$V_{DD} = 800\text{ V}$, $I_D = 56.7\text{ A}$, $V_{GS} = -2/18\text{ V}$, turn-on pulse		26		nC
Gate-to-drain charge	Q_{GD}	$V_{DD} = 800\text{ V}$, $I_D = 56.7\text{ A}$, $V_{GS} = -2/18\text{ V}$, turn-on pulse		34		nC
Turn-on delay time	$t_{d(on)}$	$V_{DD} = 800\text{ V}$, $I_D = 56.7\text{ A}$, $V_{GS} = 0/18\text{ V}$, $R_{GS(on)} = 2.3\ \Omega$, $R_{GS(off)} = 2.3\ \Omega$, $L_\sigma = 15\text{ nH}$, diode: body diode at $V_{GS} = 0\text{ V}$	$T_{vj} = 25\text{ }^\circ\text{C}$	10		ns
			$T_{vj} = 175\text{ }^\circ\text{C}$	10		
Rise time	t_r	$V_{DD} = 800\text{ V}$, $I_D = 56.7\text{ A}$, $V_{GS} = 0/18\text{ V}$, $R_{GS(on)} = 2.3\ \Omega$, $R_{GS(off)} = 2.3\ \Omega$, $L_\sigma = 15\text{ nH}$, diode: body diode at $V_{GS} = 0\text{ V}$	$T_{vj} = 25\text{ }^\circ\text{C}$	20.6		ns
			$T_{vj} = 175\text{ }^\circ\text{C}$	20		
Turn-off delay time	$t_{d(off)}$	$V_{DD} = 800\text{ V}$, $I_D = 56.7\text{ A}$, $V_{GS} = 0/18\text{ V}$, $R_{GS(on)} = 2.3\ \Omega$, $R_{GS(off)} = 2.3\ \Omega$, $L_\sigma = 15\text{ nH}$, diode: body diode at $V_{GS} = 0\text{ V}$	$T_{vj} = 25\text{ }^\circ\text{C}$	19.7		ns
			$T_{vj} = 175\text{ }^\circ\text{C}$	34.5		
Fall time	t_f	$V_{DD} = 800\text{ V}$, $I_D = 56.7\text{ A}$, $V_{GS} = 0/18\text{ V}$, $R_{GS(on)} = 2.3\ \Omega$, $R_{GS(off)} = 2.3\ \Omega$, $L_\sigma = 15\text{ nH}$, diode: body diode at $V_{GS} = 0\text{ V}$	$T_{vj} = 25\text{ }^\circ\text{C}$	13.2		ns
			$T_{vj} = 175\text{ }^\circ\text{C}$	15.5		
Turn-on energy	E_{on}	$V_{DD} = 800\text{ V}$, $I_D = 56.7\text{ A}$, $V_{GS} = 0/18\text{ V}$, $R_{GS(on)} = 2.3\ \Omega$, $R_{GS(off)} = 2.3\ \Omega$, $L_\sigma = 15\text{ nH}$, diode: body diode at $V_{GS} = 0\text{ V}$	$T_{vj} = 25\text{ }^\circ\text{C}$	620		μJ
			$T_{vj} = 175\text{ }^\circ\text{C}$	1160		
Turn-off energy	E_{off}	$V_{DD} = 800\text{ V}$, $I_D = 56.7\text{ A}$, $V_{GS} = 0/18\text{ V}$, $R_{GS(on)} = 2.3\ \Omega$, $R_{GS(off)} = 2.3\ \Omega$, $L_\sigma = 15\text{ nH}$, diode: body diode at $V_{GS} = 0\text{ V}$	$T_{vj} = 25\text{ }^\circ\text{C}$	270		μJ
			$T_{vj} = 175\text{ }^\circ\text{C}$	350		

(table continues...)

Table 4 (continued) Characteristic values

Parameter	Symbol	Note or test condition	Values			Unit
			Min.	Typ.	Max.	
Total switching energy ¹⁾	E_{tot}	$V_{DD} = 800\text{ V}$, $I_D = 56.7\text{ A}$, $V_{GS} = 0/18\text{ V}$, $R_{GS(on)} = 2.3\ \Omega$, $R_{GS(off)} = 2.3\ \Omega$, $L_\sigma = 15\text{ nH}$, diode: body diode at $V_{GS} = 0\text{ V}$	$T_{vj} = 25\text{ °C}$	970		μJ
			$T_{vj} = 175\text{ °C}$	1750		
Virtual junction temperature	T_{vj}		-55		175	$^{\circ}\text{C}$
Virtual junction temperature	$T_{vj(over)}$	overload, cumulative max. 100 h ²⁾			200	$^{\circ}\text{C}$

1) including E_{fr}

2) up to 5000 cycles. Maximum ΔT limited to 100 K.

Note: The chip technology was characterized up to 200 kV/ μs . The measured dV/dt was limited by measurement test setup and package.

Characteristics at $T_{vj} = 25^{\circ}\text{C}$, unless otherwise specified.

3 Body diode (MOSFET)

Table 5 Maximum rated values

Parameter	Symbol	Note or test condition	Values	Unit
Drain-source voltage	V_{DSS}	$T_{vj} \geq 25\text{ °C}$	1200	V
Peak reverse drain current, t_p limited by $T_{vj(max)}$	I_{SM}	$V_{GS} = 0\text{ V}$	145	A

Table 6 Characteristic values

Parameter	Symbol	Note or test condition	Values			Unit
			Min.	Typ.	Max.	
Drain-source reverse voltage	V_{SD}	$I_{SD} = 56.7\text{ A}$, $V_{GS} = 0\text{ V}$	$T_{vj} = 25\text{ °C}$	4.2	5.5	V
			$T_{vj} = 100\text{ °C}$	4.11		
			$T_{vj} = 175\text{ °C}$	4.05		
MOSFET forward recovery charge	Q_{fr}	$V_{DD} = 800\text{ V}$, $I_{SD} = 56.7\text{ A}$, $V_{GS} = 0\text{ V}$, $di_{SD}/dt = 1000\text{ A}/\mu\text{s}$, Q_{fr} includes also Q_C	$T_{vj} = 25\text{ °C}$	0.55		μC
			$T_{vj} = 175\text{ °C}$	1.06		
MOSFET peak forward recovery current	I_{frm}	$V_{DD} = 800\text{ V}$, $I_{SD} = 56.7\text{ A}$, $V_{GS} = 0\text{ V}$, $di_{SD}/dt = 1000\text{ A}/\mu\text{s}$, Q_{fr} includes also Q_C	$T_{vj} = 25\text{ °C}$	10.1		A
			$T_{vj} = 175\text{ °C}$	15.9		

(table continues...)

Table 6 (continued) **Characteristic values**

Parameter	Symbol	Note or test condition	Values			Unit
			Min.	Typ.	Max.	
MOSFET forward recovery energy	E_{fr}	$V_{DD} = 800\text{ V}$, $I_{SD} = 56.7\text{ A}$, $V_{GS} = 0\text{ V}$, $di_{SD}/dt = 1000\text{ A}/\mu\text{s}$, Q_{fr} includes also Q_C	$T_{vj} = 25\text{ °C}$	80		μJ
			$T_{vj} = 175\text{ °C}$	240		
Virtual junction temperature	T_{vj}		-55		175	$^{\circ}\text{C}$
Virtual junction temperature	$T_{vj(over)}$	overload, cumulative max. 100 h ¹⁾			200	$^{\circ}\text{C}$

1) up to 5000 cycles. Maximum ΔT limited to 100 K.

4 Characteristics diagrams

Reverse bias safe operating area (RBSOA)

$$I_{DS} = f(V_{DS})$$

$$T_{vj} \leq 200\text{ °C}, V_{GS} = 0/18\text{ V}, T_c = 25\text{ °C}$$

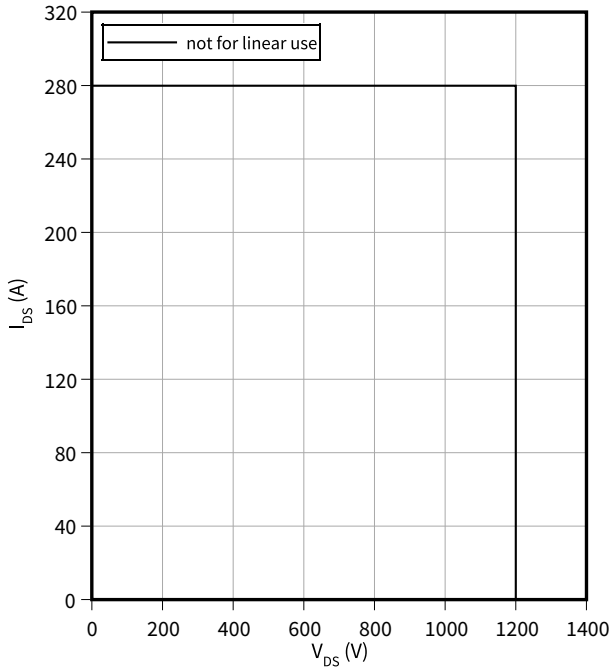

Power dissipation as a function of case temperature

$$P_{tot} = f(T_c)$$

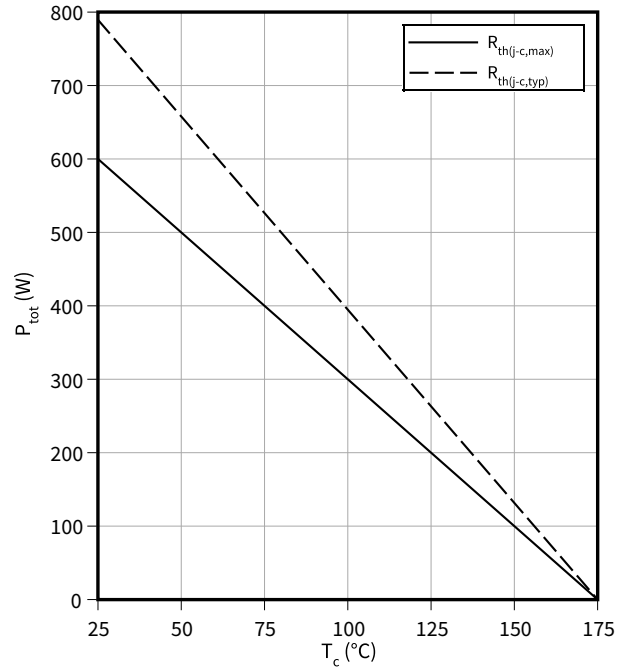

Maximum DC drain to source current as a function of case temperature limited by bond wire

$$I_{DS} = f(T_c)$$

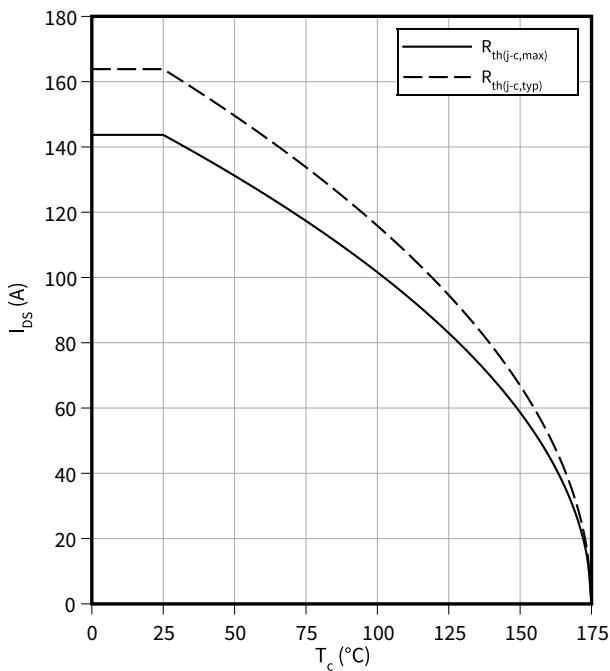

Maximum source to drain current as a function of case temperature limited by bond wire

$$I_{SD} = f(T_c)$$

$$V_{GS} = 0\text{ V}$$

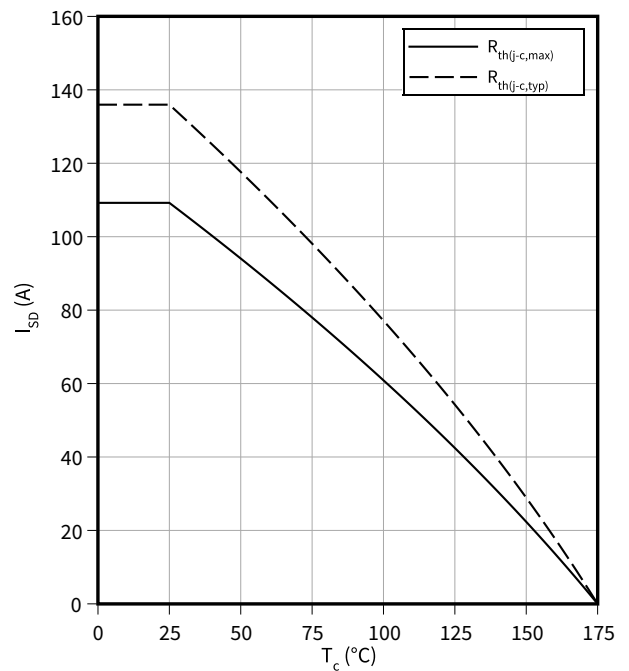

4 Characteristics diagrams

Typical transfer characteristic

$I_{DS} = f(V_{GS})$
 $V_{DS} = 20\text{ V}, t_p = 20\ \mu\text{s}$

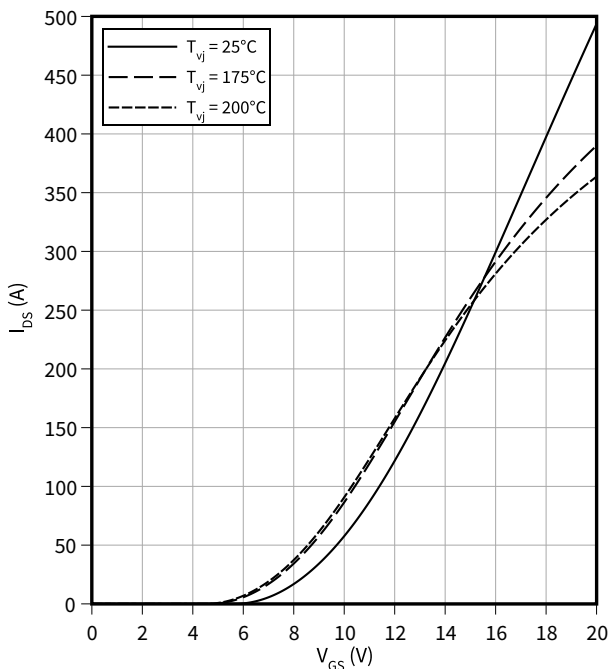

Typical gate-source threshold voltage as a function of junction temperature

$V_{GS(th)} = f(T_{vj})$
 $I_D = 17.8\text{ mA}$

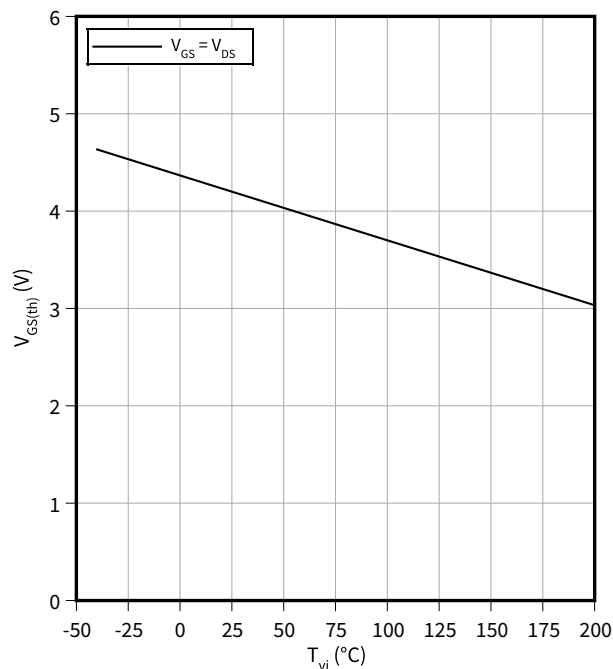

Typical output characteristic, V_{GS} as parameter

$I_{DS} = f(V_{DS})$
 $T_{vj} = 25\ ^\circ\text{C}, t_p = 20\ \mu\text{s}$

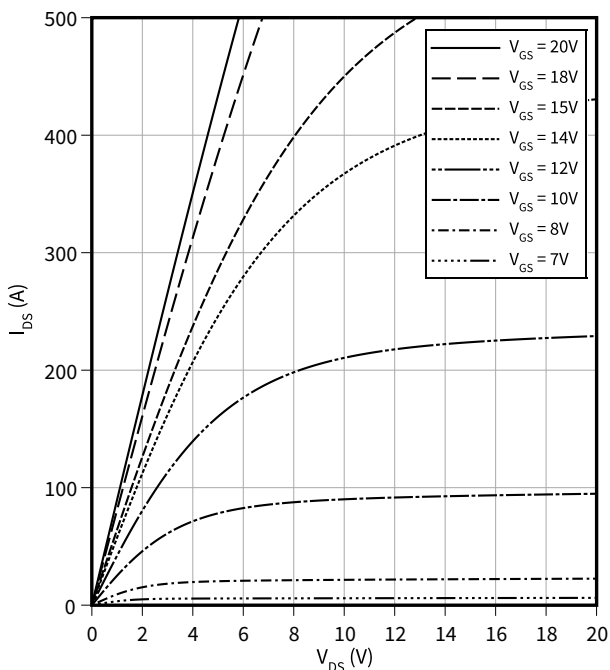

Typical output characteristic, V_{GS} as parameter

$I_{DS} = f(V_{DS})$
 $T_{vj} = 175\ ^\circ\text{C}, t_p = 20\ \mu\text{s}$

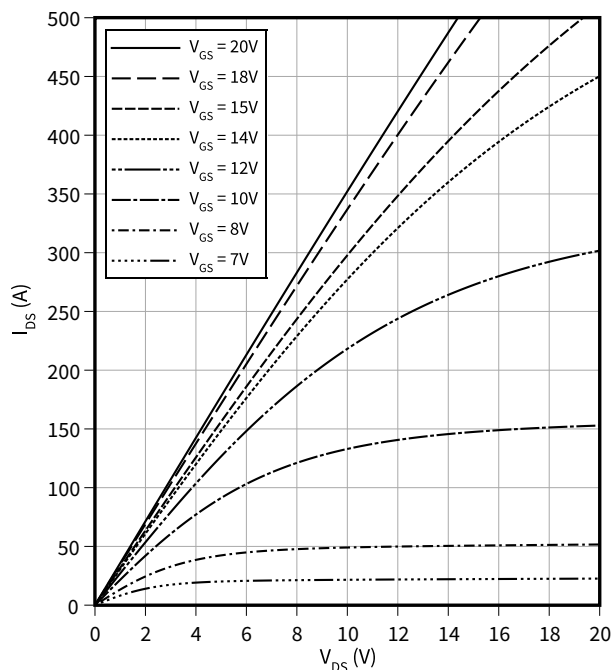

4 Characteristics diagrams

Typical on-state resistance as a function of junction temperature

$R_{DS(on)} = f(T_{vj})$
 $I_D = 56.7 \text{ A}$

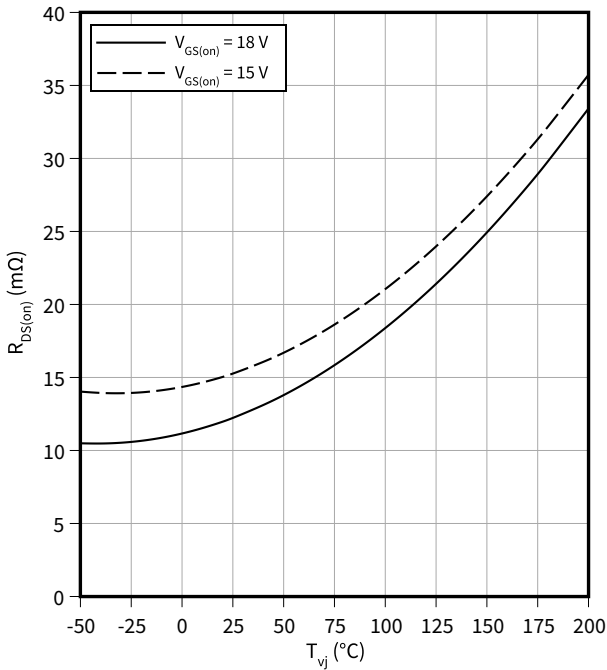

Typical gate charge

$V_{GS} = f(Q_G)$
 $I_D = 56.7 \text{ A}, V_{DS} = 800 \text{ V}$

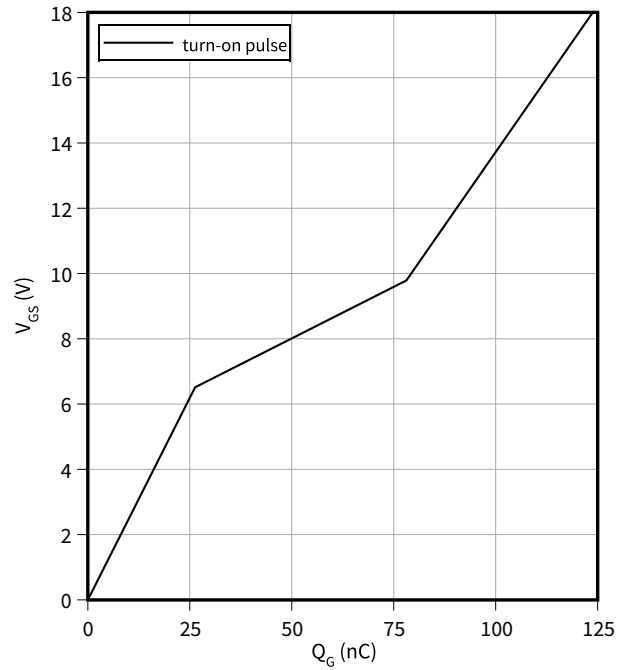

Typical capacitance as a function of drain-source voltage

$C = f(V_{DS})$
 $f = 100 \text{ kHz}, V_{GS} = 0 \text{ V}$

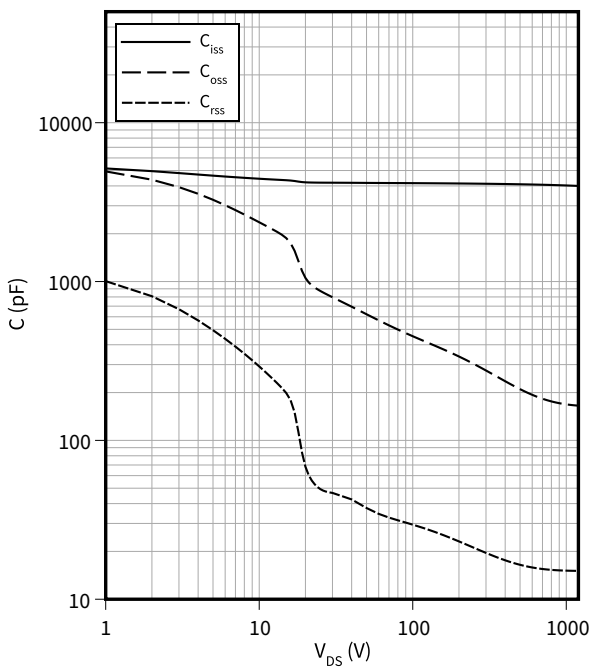

Typical reverse drain voltage as function of junction temperature

$V_{SD} = f(T_{vj})$
 $I_{SD} = 56.7 \text{ A}, V_{GS} = 0 \text{ V}$

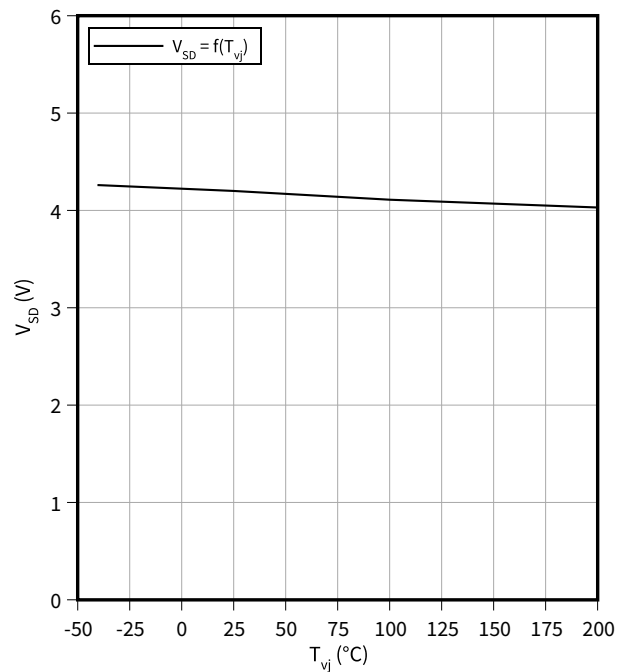

4 Characteristics diagrams

Typical reverse drain current as function of reverse drain voltage, V_{GS} as parameter

$I_{SD} = f(V_{SD})$
 $T_{vj} = 25\text{ °C}$, $t_p = 20\ \mu\text{s}$

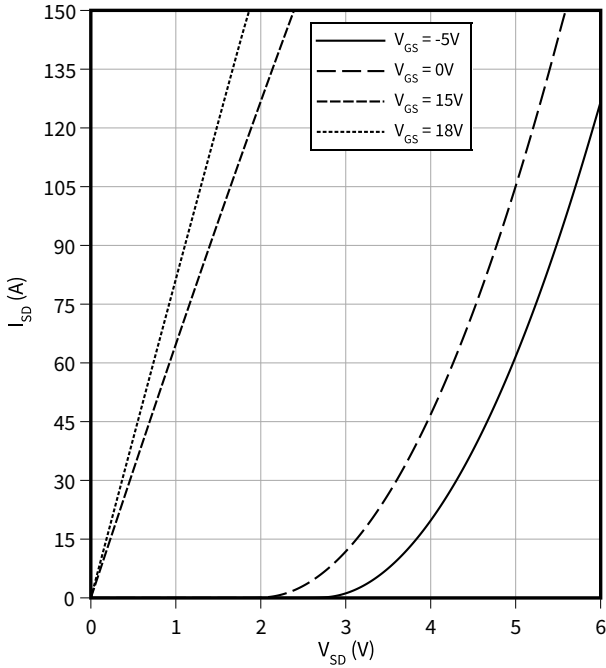

Typical reverse drain current as function of reverse drain voltage, V_{GS} as parameter

$I_{SD} = f(V_{SD})$
 $T_{vj} = 175\text{ °C}$, $t_p = 20\ \mu\text{s}$

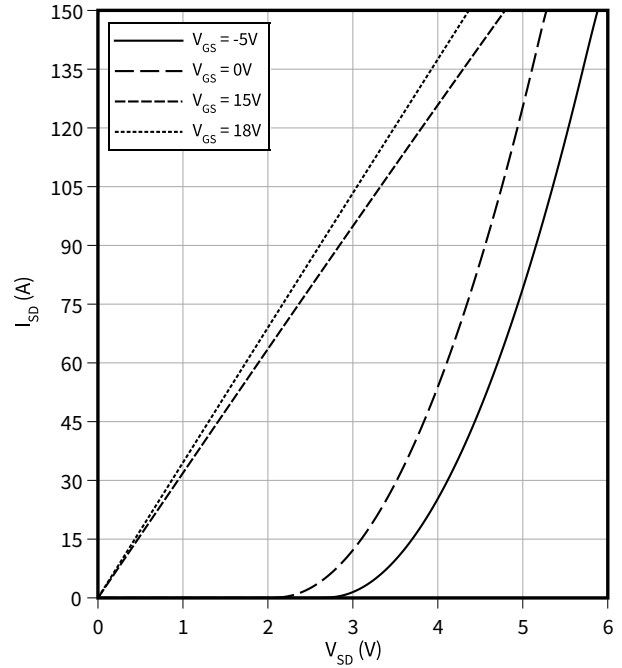

Typical switching energy as a function of junction temperature, test circuit in Fig. F, 2nd device own body diode: $V_{GS} = 0\text{ V}$

$E = f(T_{vj})$
 $V_{GS} = 0/18\text{ V}$, $I_D = 56.7\text{ A}$, $R_{G,ext} = 2.3\ \Omega$, $V_{DD} = 800\text{ V}$

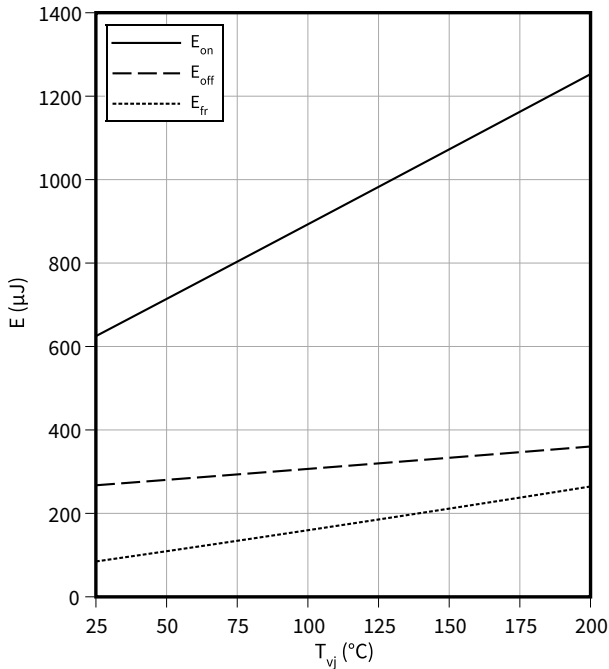

Typical switching energy as a function of drain current, test circuit in Fig. F, 2nd device own body diode: $V_{GS} = 0\text{ V}$

$E = f(I_D)$
 $V_{GS} = 0/18\text{ V}$, $T_{vj} = 175\text{ °C}$, $R_{G,ext} = 2.3\ \Omega$, $V_{DD} = 800\text{ V}$

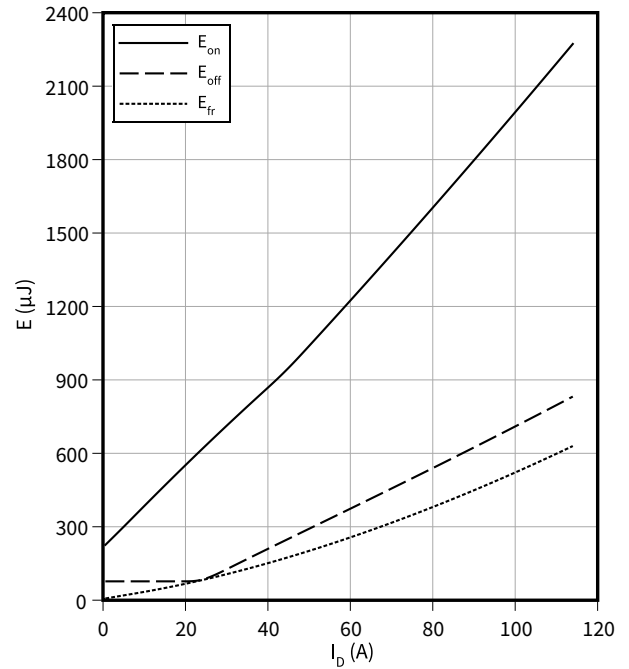

4 Characteristics diagrams

Typical switching energy as a function of gate resistance, test circuit in Fig. F, 2nd device own body diode: $V_{GS} = 0\text{ V}$

$E = f(R_{G,ext})$

$V_{GS} = 0/18\text{ V}$, $I_D = 56.7\text{ A}$, $T_{vj} = 175\text{ °C}$, $V_{DD} = 800\text{ V}$

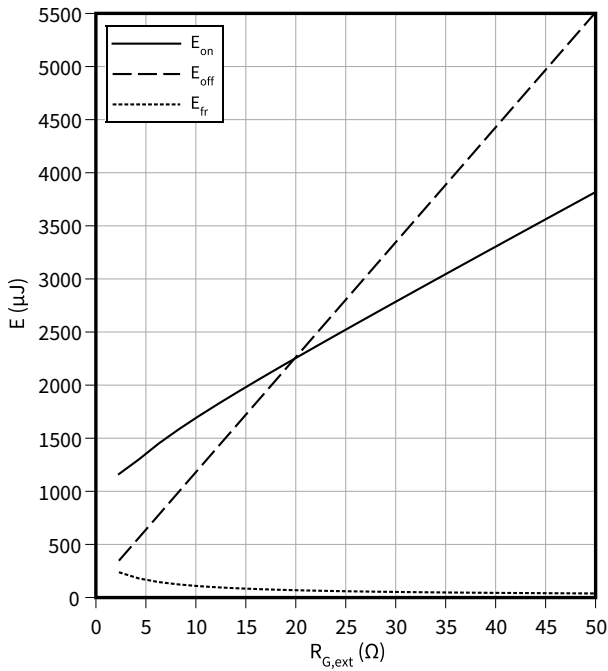

Typical switching times as a function of gate resistance, test circuit in Fig. F, 2nd device own body diode: $V_{GS} = 0\text{ V}$

$t = f(R_{G,ext})$

$V_{GS} = 0/18\text{ V}$, $I_D = 56.7\text{ A}$, $T_{vj} = 175\text{ °C}$, $V_{DD} = 800\text{ V}$

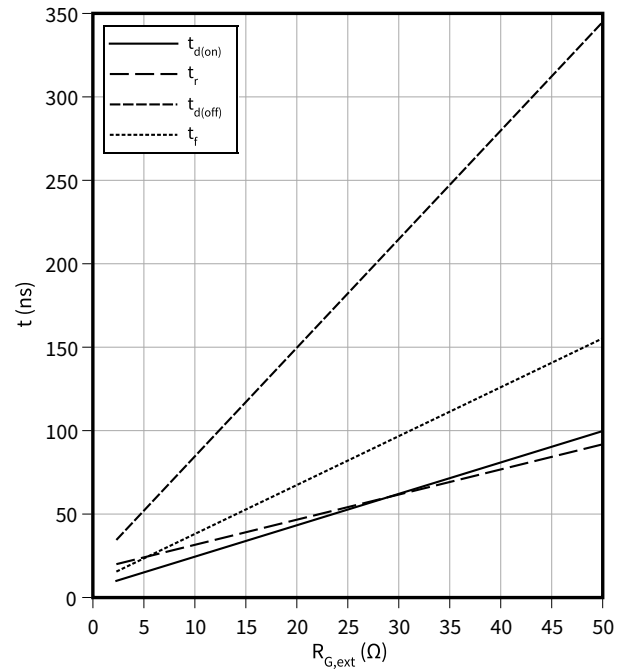

Typical reverse recovery charge as a function of reverse drain current slope, test circuit in Fig. F, 2nd device own body diode: $V_{GS} = 0\text{ V}$

$Q_{fr} = f(di_{SD}/dt)$

$V_{GS} = 0/18\text{ V}$, $I_{SD} = 56.7\text{ A}$, $V_{DD} = 800\text{ V}$

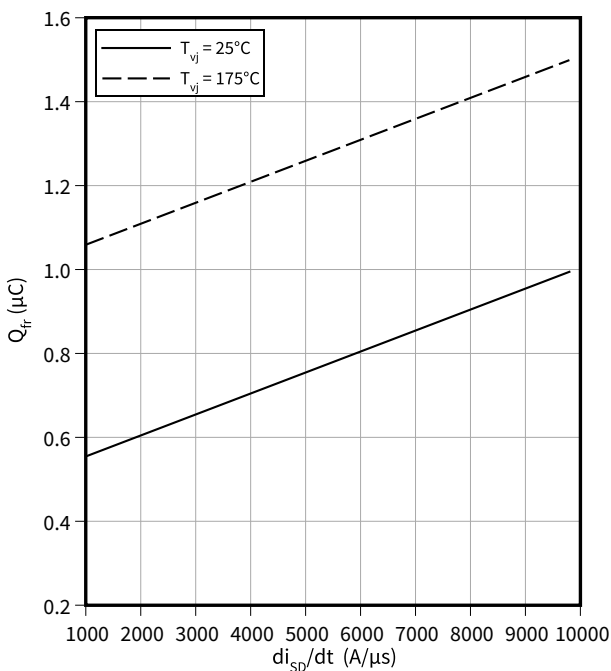

Typical reverse recovery current as a function of reverse drain current slope, test circuit in Fig. F, 2nd device own body diode: $V_{GS} = 0\text{ V}$

$I_{frm} = f(di_{SD}/dt)$

$V_{GS} = 0/18\text{ V}$, $I_{SD} = 56.7\text{ A}$, $V_{DD} = 800\text{ V}$

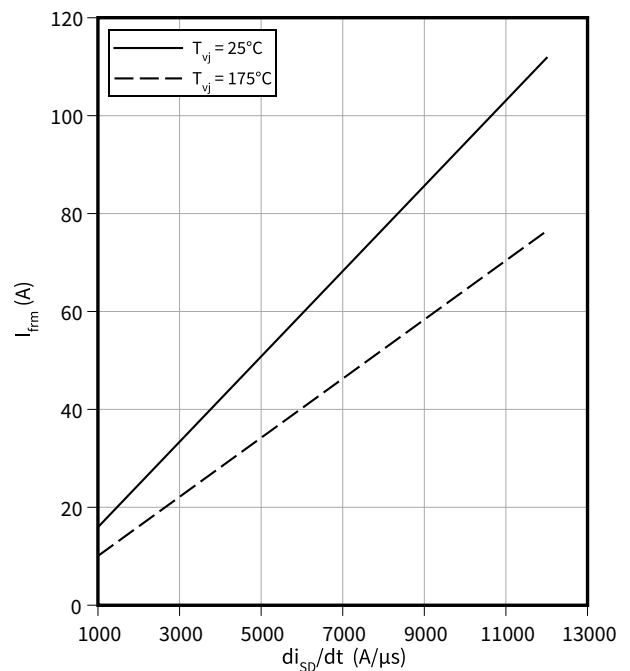

4 Characteristics diagrams

Typical switching energy as a function of dead time / blanking time, test circuit in Fig. F, 2nd device own body diode: $V_{GS} = -5\text{ V}$

$E = f(t_{dead})$

$V_{GS} = 0/18\text{ V}$, $I_D = 56.7\text{ A}$, $T_{vj} = 175\text{ °C}$, $R_{G,ext} = 2.3\text{ }\Omega$

$V_{DD} = 800\text{ V}$

Max. transient thermal impedance (MOSFET/diode)

$Z_{th(j-c),max} = f(t_p)$

$D = t_p/T$

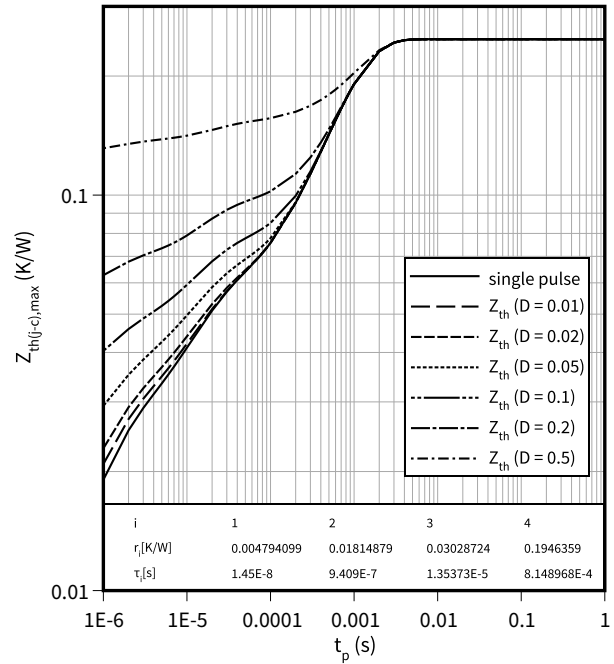
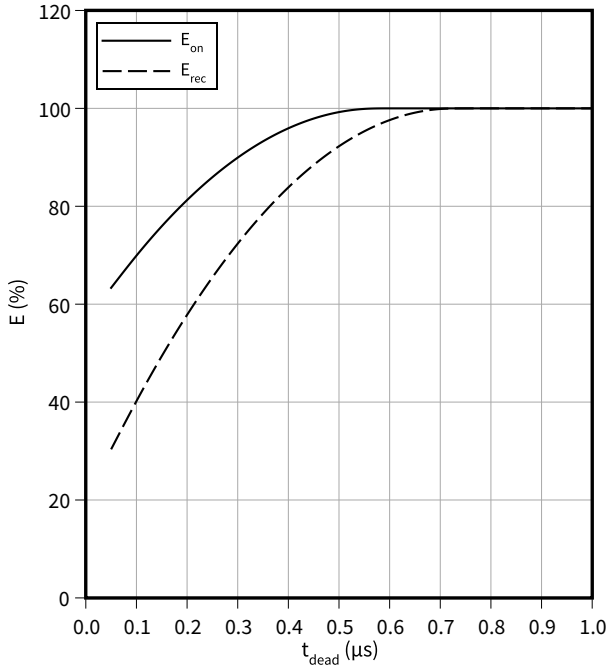

5 Package outlines

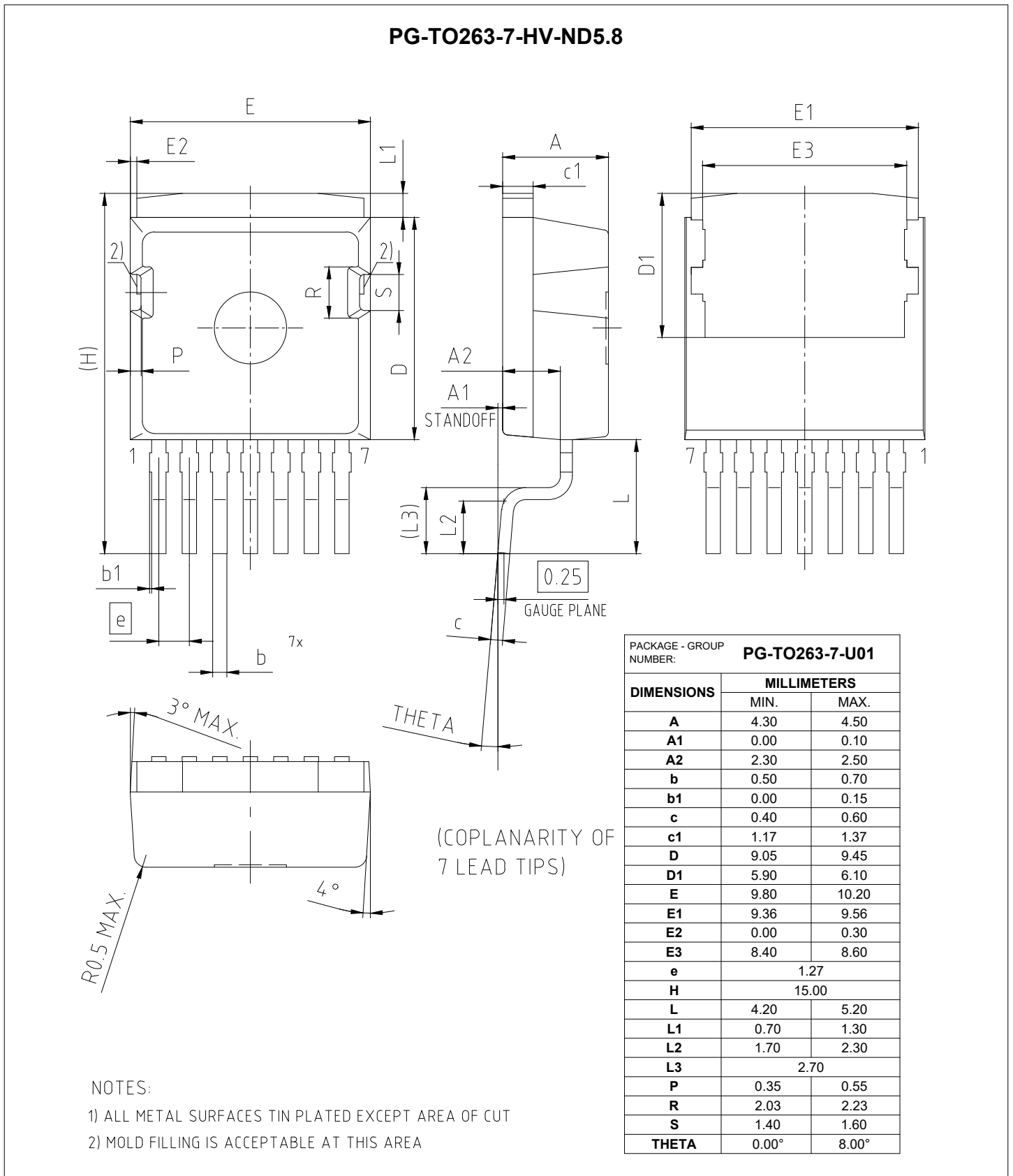

Figure 1

6 Testing conditions

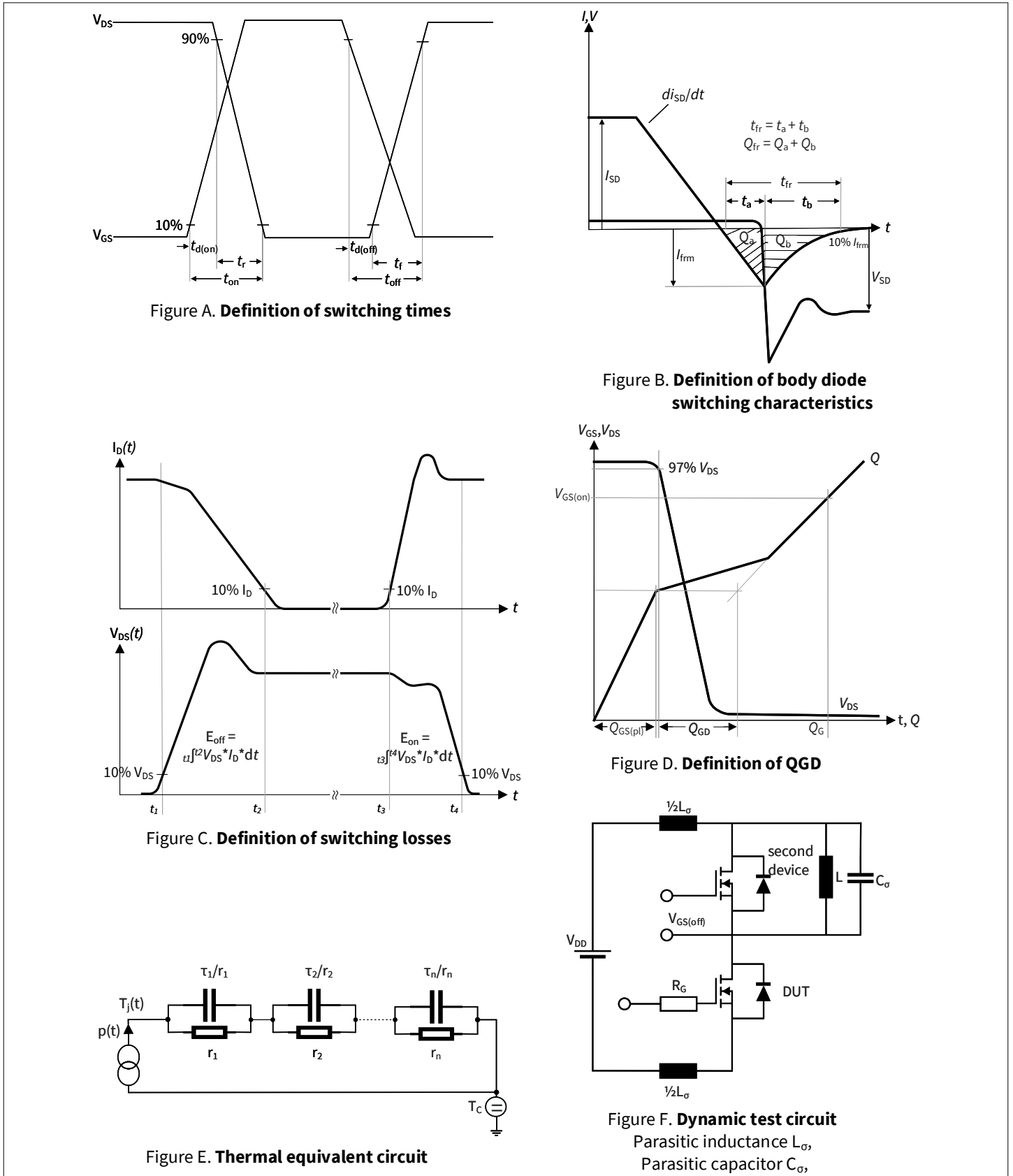

Figure 2

Revision history

Document revision	Date of release	Description of changes
0.10	2023-08-08	Preliminary datasheet
1.00	2023-09-29	Final datasheet
1.10	2024-01-11	Negative gate voltage values updated Additional capacitance & charge values added E = f(t _{dead}) graph y-axis correction to percentage values Editorial changes

Trademarks

All referenced product or service names and trademarks are the property of their respective owners.

Edition 2024-01-12

Published by

Infineon Technologies AG

81726 Munich, Germany

© 2024 Infineon Technologies AG

All Rights Reserved.

Do you have a question about any aspect of this document?

Email: erratum@infineon.com

Document reference

IFX-ABH435-003

Important notice

The information given in this document shall in no event be regarded as a guarantee of conditions or characteristics ("Beschaffheitsgarantie").

With respect to any examples, hints or any typical values stated herein and/or any information regarding the application of the product, Infineon Technologies hereby disclaims any and all warranties and liabilities of any kind, including without limitation warranties of non-infringement of intellectual property rights of any third party.

In addition, any information given in this document is subject to customer's compliance with its obligations stated in this document and any applicable legal requirements, norms and standards concerning customer's products and any use of the product of Infineon Technologies in customer's applications.

The data contained in this document is exclusively intended for technically trained staff. It is the responsibility of customer's technical departments to evaluate the suitability of the product for the intended application and the completeness of the product information given in this document with respect to such application.

Please note that this product is not qualified according to the AEC Q100 or AEC Q101 documents of the Automotive Electronics Council.

Warnings

Due to technical requirements products may contain dangerous substances. For information on the types in question please contact your nearest Infineon Technologies office.

Except as otherwise explicitly approved by Infineon Technologies in a written document signed by authorized representatives of Infineon Technologies, Infineon Technologies' products may not be used in any applications where a failure of the product or any consequences of the use thereof can reasonably be expected to result in personal injury.