

**Final datasheet**

**CoolSiC™ 1200 V SiC MOSFET G2 : Silicon Carbide MOSFET**

**Features**

- $V_{DSS} = 1200\text{ V}$  at  $T_{vj} = 25^\circ\text{C}$
- $I_{DC} = 53\text{ A}$  at  $T_C = 100^\circ\text{C}$
- $R_{DS(on)} = 25.4\text{ m}\Omega$  at  $V_{GS} = 18\text{ V}$ ,  $T_{vj} = 25^\circ\text{C}$
- Very low switching losses
- Overload operation up to  $T_{vj} = 200^\circ\text{C}$
- Short circuit withstand time  $2\text{ }\mu\text{s}$
- Benchmark gate threshold voltage,  $V_{GS(th)} = 4.2\text{ V}$
- Robust against parasitic turn on, 0 V turn-off gate voltage can be applied
- Robust body diode for hard commutation
- .XT interconnection technology for best-in-class thermal performance
- Suitable Infineon gate drivers can be found under <https://www.infineon.com/gdfinder>

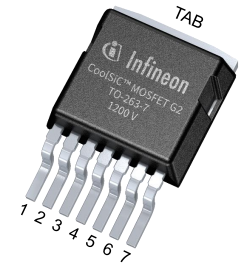

- Halogen-free
- Green
- Lead-free
- RoHS

**Potential applications**

- EV-Charging
- Online UPS/Industrial UPS
- Solar power optimizer
- String inverter
- General purpose drives (GPD)

**Product validation**

- Qualified for industrial applications according to the relevant tests of JEDEC47/20/22

**Description**

Pin definition:

- Pin 1 - Gate
- Pin 2 - Kelvin sense contact
- Pin 3...7 - Source
- Tab - Drain

Note: the source and sense pins are not exchangeable, their exchange might lead to malfunction (only for 4pin, TO263-7L)

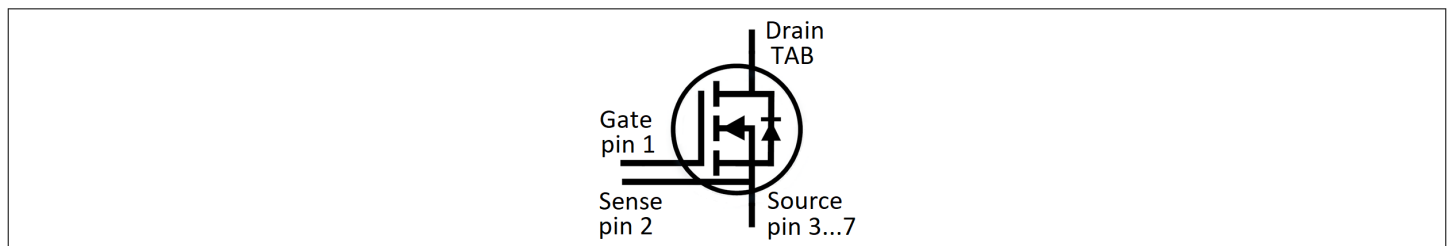

Type	Package	Marking
IMBG120R026M2H	PG-TO263-7-HV-ND5.8	12M2H026

## Table of contents

	<b>Description</b> .....	1
	<b>Features</b> .....	1
	<b>Potential applications</b> .....	1
	<b>Product validation</b> .....	1
	<b>Table of contents</b> .....	2
<b>1</b>	<b>Package</b> .....	3
<b>2</b>	<b>MOSFET</b> .....	3
<b>3</b>	<b>Body diode (MOSFET)</b> .....	6
<b>4</b>	<b>Characteristics diagrams</b> .....	8
<b>5</b>	<b>Package outlines</b> .....	14
<b>6</b>	<b>Testing conditions</b> .....	15
	<b>Revision history</b> .....	16
	<b>Disclaimer</b> .....	17

## 1 Package

**Table 1** Characteristic values

Parameter	Symbol	Note or test condition	Values			Unit
			Min.	Typ.	Max.	
Storage temperature	$T_{stg}$		-55		150	°C
Soldering temperature	$T_{sold}$	reflow soldering (MSL1 according to JEDEC J-STA-020)			260	°C
Thermal resistance, junction-ambient	$R_{th(j-a)}$				62	K/W
MOSFET/body diode thermal resistance, junction-case	$R_{th(j-c)}$			0.34	0.44	K/W

## 2 MOSFET

**Table 2** Maximum rated values

Parameter	Symbol	Note or test condition	Values	Unit	
Drain-source voltage	$V_{DSS}$	$T_{vj} \geq 25 \text{ °C}$	1200	V	
Continuous DC drain current for $R_{th(j-c,max)}$ , limited by $T_{vj(max)}$	$I_{DDC}$	$V_{GS} = 18 \text{ V}$	$T_c = 25 \text{ °C}$	75	A
			$T_c = 100 \text{ °C}$	53	
Peak drain current, $t_p$ limited by $T_{vj(max)}$ <sup>1)</sup>	$I_{DM}$	$V_{GS} = 18 \text{ V}$	159	A	
Gate-source voltage, max. transient voltage	$V_{GS}$	$t_p \leq 0.5 \text{ }\mu\text{s}$ , $D < 0.01$	-10...23	V	
Gate-source voltage, max. static voltage	$V_{GS}$		-7...20	V	
Avalanche energy, single pulse	$E_{AS}$	$I_D = 27.3 \text{ A}$ , $V_{DD} = 50 \text{ V}$ , $L = 0.9 \text{ mH}$	343	mJ	
Avalanche energy, repetitive	$E_{AR}$	$I_D = 27.3 \text{ A}$ , $V_{DD} = 50 \text{ V}$ , $L = 4.6 \text{ mH}$	1.17	mJ	
Short-circuit withstand time	$t_{SC}$	$V_{DD} \leq 800 \text{ V}$ , $V_{DS,peak} < 1200 \text{ V}$ , $V_{GS(on)} = 15 \text{ V}$ , $T_{vj(start)} = 25 \text{ °C}$	2	$\mu\text{s}$	
Power dissipation, limited by $T_{vj(max)}$	$P_{tot}$		$T_c = 25 \text{ °C}$	335	W
			$T_c = 100 \text{ °C}$	168	

1) verified by design.

**Table 3 Recommended values**

Parameter	Symbol	Note or test condition	Values	Unit
Recommended turn-on gate voltage	$V_{GS(on)}$		15...18	V
Recommended turn-off gate voltage	$V_{GS(off)}$		-5...0	V

**Table 4 Characteristic values**

Parameter	Symbol	Note or test condition	Values			Unit	
			Min.	Typ.	Max.		
Drain-source on-state resistance	$R_{DS(on)}$	$I_D = 27.3 \text{ A}$	$T_{vj} = 25 \text{ }^\circ\text{C}$ , $V_{GS(on)} = 18 \text{ V}$	25.4		mΩ	
			$T_{vj} = 150 \text{ }^\circ\text{C}$ , $V_{GS(on)} = 18 \text{ V}$	52	68		
			$T_{vj} = 175 \text{ }^\circ\text{C}$ , $V_{GS(on)} = 18 \text{ V}$	60			
			$T_{vj} = 25 \text{ }^\circ\text{C}$ , $V_{GS(on)} = 15 \text{ V}$	31.7			
Gate-source threshold voltage	$V_{GS(th)}$	$I_D = 8.6 \text{ mA}$ , $V_{DS} = V_{GS}$ (tested after 1 ms pulse at $V_{GS} = 20 \text{ V}$ )	$T_{vj} = 25 \text{ }^\circ\text{C}$	3.5	4.2	5.1	V
			$T_{vj} = 175 \text{ }^\circ\text{C}$		3.2		
Zero gate-voltage drain current	$I_{DSS}$	$V_{DS} = 1200 \text{ V}$ , $V_{GS} = 0 \text{ V}$	$T_{vj} = 25 \text{ }^\circ\text{C}$			240	μA
			$T_{vj} = 175 \text{ }^\circ\text{C}$		4		
Gate leakage current	$I_{GSS}$	$V_{DS} = 0 \text{ V}$	$V_{GS} = 23 \text{ V}$			120	nA
			$V_{GS} = -10 \text{ V}$			-120	
Forward transconductance	$g_{fs}$	$I_D = 27.3 \text{ A}$ , $V_{DS} = 20 \text{ V}$		12.5		S	
Internal gate resistance	$R_{G,int}$	$f = 1 \text{ MHz}$ , $V_{AC} = 25 \text{ mV}$		5.6		Ω	
Input capacitance	$C_{iss}$	$V_{DD} = 800 \text{ V}$ , $V_{GS} = 0 \text{ V}$ , $f = 100 \text{ kHz}$ , $V_{AC} = 25 \text{ mV}$		1990		pF	
Output capacitance	$C_{oss}$	$V_{DD} = 800 \text{ V}$ , $V_{GS} = 0 \text{ V}$ , $f = 100 \text{ kHz}$ , $V_{AC} = 25 \text{ mV}$		85		pF	
Reverse transfer capacitance	$C_{rss}$	$V_{DD} = 800 \text{ V}$ , $V_{GS} = 0 \text{ V}$ , $f = 100 \text{ kHz}$ , $V_{AC} = 25 \text{ mV}$		7.4		pF	
$C_{oss}$ stored energy	$E_{oss}$	$V_{DD} = 800 \text{ V}$ , $V_{GS} = 0 \text{ V}$ , $f = 100 \text{ kHz}$ , $V_{AC} = 25 \text{ mV}$		36		μJ	
Output charge	$Q_{oss}$	Calculated by $C_{oss}(f)V_{DS}$ @100 kHz		132.6		nC	
Effective output capacitance, energy related	$C_{o(er)}$	$V_{DD} = 0...800 \text{ V}$ , $V_{GS} = 0 \text{ V}$		112.5		pF	
Effective output capacitance, time related	$C_{o(tr)}$	$I_C = \text{constant}$ , $V_{DD} = 0...800 \text{ V}$ , $V_{GS} = 0 \text{ V}$		165.7		pF	
Total gate charge	$Q_G$	$V_{DD} = 800 \text{ V}$ , $I_D = 27.3 \text{ A}$ , $V_{GS} = -2/18 \text{ V}$ , turn-on pulse		60		nC	

**(table continues...)**

**Table 4 (continued) Characteristic values**

Parameter	Symbol	Note or test condition	Values			Unit
			Min.	Typ.	Max.	
Plateau gate charge	$Q_{GS(pl)}$	$V_{DD} = 800\text{ V}$ , $I_D = 27.3\text{ A}$ , $V_{GS} = -2/18\text{ V}$ , turn-on pulse		12.9		nC
Gate-to-drain charge	$Q_{GD}$	$V_{DD} = 800\text{ V}$ , $I_D = 27.3\text{ A}$ , $V_{GS} = -2/18\text{ V}$ , turn-on pulse		16.2		nC
Turn-on delay time	$t_{d(on)}$	$V_{DD} = 800\text{ V}$ , $I_D = 27.3\text{ A}$ , $V_{GS} = 0/18\text{ V}$ , $R_{GS(on)} = 2.3\ \Omega$ , $R_{GS(off)} = 2.3\ \Omega$ , $L_\sigma = 15\text{ nH}$ , diode: body diode at $V_{GS} = 0\text{ V}$	$T_{vj} = 25\text{ }^\circ\text{C}$	5		ns
			$T_{vj} = 175\text{ }^\circ\text{C}$	4.9		
Rise time	$t_r$	$V_{DD} = 800\text{ V}$ , $I_D = 27.3\text{ A}$ , $V_{GS} = 0/18\text{ V}$ , $R_{GS(on)} = 2.3\ \Omega$ , $R_{GS(off)} = 2.3\ \Omega$ , $L_\sigma = 15\text{ nH}$ , diode: body diode at $V_{GS} = 0\text{ V}$	$T_{vj} = 25\text{ }^\circ\text{C}$		16.2	ns
			$T_{vj} = 175\text{ }^\circ\text{C}$		15.9	
Turn-off delay time	$t_{d(off)}$	$V_{DD} = 800\text{ V}$ , $I_D = 27.3\text{ A}$ , $V_{GS} = 0/18\text{ V}$ , $R_{GS(on)} = 2.3\ \Omega$ , $R_{GS(off)} = 2.3\ \Omega$ , $L_\sigma = 15\text{ nH}$ , diode: body diode at $V_{GS} = 0\text{ V}$	$T_{vj} = 25\text{ }^\circ\text{C}$		9.7	ns
			$T_{vj} = 175\text{ }^\circ\text{C}$		16.9	
Fall time	$t_f$	$V_{DD} = 800\text{ V}$ , $I_D = 27.3\text{ A}$ , $V_{GS} = 0/18\text{ V}$ , $R_{GS(on)} = 2.3\ \Omega$ , $R_{GS(off)} = 2.3\ \Omega$ , $L_\sigma = 15\text{ nH}$ , diode: body diode at $V_{GS} = 0\text{ V}$	$T_{vj} = 25\text{ }^\circ\text{C}$		6.3	ns
			$T_{vj} = 175\text{ }^\circ\text{C}$		7.4	
Turn-on energy	$E_{on}$	$V_{DD} = 800\text{ V}$ , $I_D = 27.3\text{ A}$ , $V_{GS} = 0/18\text{ V}$ , $R_{GS(on)} = 2.3\ \Omega$ , $R_{GS(off)} = 2.3\ \Omega$ , $L_\sigma = 15\text{ nH}$ , diode: body diode at $V_{GS} = 0\text{ V}$	$T_{vj} = 25\text{ }^\circ\text{C}$		211	$\mu\text{J}$
			$T_{vj} = 175\text{ }^\circ\text{C}$		406	
Turn-off energy	$E_{off}$	$V_{DD} = 800\text{ V}$ , $I_D = 27.3\text{ A}$ , $V_{GS} = 0/18\text{ V}$ , $R_{GS(on)} = 2.3\ \Omega$ , $R_{GS(off)} = 2.3\ \Omega$ , $L_\sigma = 15\text{ nH}$ , diode: body diode at $V_{GS} = 0\text{ V}$	$T_{vj} = 25\text{ }^\circ\text{C}$		44	$\mu\text{J}$
			$T_{vj} = 175\text{ }^\circ\text{C}$		67	

(table continues...)

**Table 4 (continued) Characteristic values**

Parameter	Symbol	Note or test condition	Values			Unit
			Min.	Typ.	Max.	
Total switching energy <sup>1)</sup>	$E_{tot}$	$V_{DD} = 800\text{ V}$ , $I_D = 27.3\text{ A}$ , $V_{GS} = 0/18\text{ V}$ , $R_{GS(on)} = 2.3\ \Omega$ , $R_{GS(off)} = 2.3\ \Omega$ , $L_\sigma = 15\text{ nH}$ , diode: body diode at $V_{GS} = 0\text{ V}$	$T_{vj} = 25\text{ }^\circ\text{C}$		315	$\mu\text{J}$
			$T_{vj} = 175\text{ }^\circ\text{C}$		653	
Virtual junction temperature	$T_{vj}$		-55		175	$^\circ\text{C}$
Virtual junction temperature	$T_{vj(over)}$	overload, cumulative max. 100 h <sup>2)</sup>			200	$^\circ\text{C}$

1) including  $E_{fr}$

2) up to 5000 cycles. Maximum  $\Delta T$  limited to 100 K.

**Note:** The chip technology was characterized up to 200 kV/ $\mu\text{s}$ . The measured  $dV/dt$  was limited by measurement test setup and package.

Characteristics at  $T_{vj} = 25^\circ\text{C}$ , unless otherwise specified.

### 3 Body diode (MOSFET)

**Table 5 Maximum rated values**

Parameter	Symbol	Note or test condition	Values	Unit
Drain-source voltage	$V_{DSS}$	$T_{vj} \geq 25\text{ }^\circ\text{C}$	1200	V
Peak reverse drain current, $t_p$ limited by $T_{vj(max)}$	$I_{SM}$	$V_{GS} = 0\text{ V}$	70	A

**Table 6 Characteristic values**

Parameter	Symbol	Note or test condition	Values			Unit
			Min.	Typ.	Max.	
Drain-source reverse voltage	$V_{SD}$	$I_{SD} = 27.3\text{ A}$ , $V_{GS} = 0\text{ V}$	$T_{vj} = 25\text{ }^\circ\text{C}$		4.2	V
			$T_{vj} = 100\text{ }^\circ\text{C}$		4.11	
			$T_{vj} = 175\text{ }^\circ\text{C}$		4.05	
MOSFET forward recovery charge	$Q_{fr}$	$V_{DD} = 800\text{ V}$ , $I_{SD} = 27.3\text{ A}$ , $V_{GS} = 0\text{ V}$ , $di_{SD}/dt = 1000\text{ A}/\mu\text{s}$ , $Q_{fr}$ includes also $Q_C$	$T_{vj} = 25\text{ }^\circ\text{C}$		0.29	$\mu\text{C}$
			$T_{vj} = 175\text{ }^\circ\text{C}$		0.54	
MOSFET peak forward recovery current	$I_{frm}$	$V_{DD} = 800\text{ V}$ , $I_{SD} = 27.3\text{ A}$ , $V_{GS} = 0\text{ V}$ , $di_{SD}/dt = 1000\text{ A}/\mu\text{s}$ , $Q_{fr}$ includes also $Q_C$	$T_{vj} = 25\text{ }^\circ\text{C}$		8.5	A
			$T_{vj} = 175\text{ }^\circ\text{C}$		11.7	

(table continues...)

**Table 6** (continued) **Characteristic values**

Parameter	Symbol	Note or test condition	Values			Unit
			Min.	Typ.	Max.	
MOSFET forward recovery energy	$E_{fr}$	$V_{DD} = 800 \text{ V}$ , $I_{SD} = 27.3 \text{ A}$ , $V_{GS} = 0 \text{ V}$ , $di_{SD}/dt = 1000 \text{ A}/\mu\text{s}$ , $Q_{fr}$ includes also $Q_C$	$T_{vj} = 25 \text{ }^\circ\text{C}$		60	$\mu\text{J}$
			$T_{vj} = 175 \text{ }^\circ\text{C}$		180	
Virtual junction temperature	$T_{vj}$		-55		175	$^\circ\text{C}$
Virtual junction temperature	$T_{vj(over)}$	overload, cumulative max. 100 h <sup>1)</sup>			200	$^\circ\text{C}$

1) up to 5000 cycles. Maximum  $\Delta T$  limited to 100 K.

## 4 Characteristics diagrams

### Reverse bias safe operating area (RBSOA)

$$I_{DS} = f(V_{DS})$$

$$T_{vj} \leq 200 \text{ }^\circ\text{C}, V_{GS} = 0/18 \text{ V}, T_c = 25 \text{ }^\circ\text{C}$$

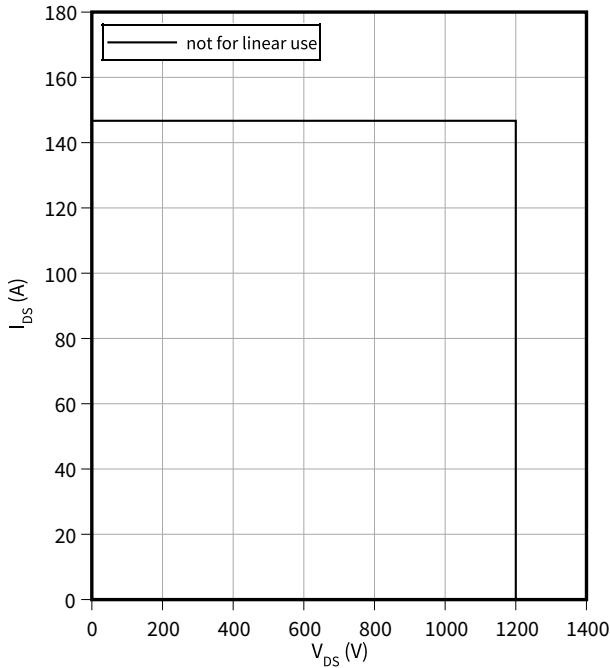

### Power dissipation as a function of case temperature

$$P_{tot} = f(T_c)$$

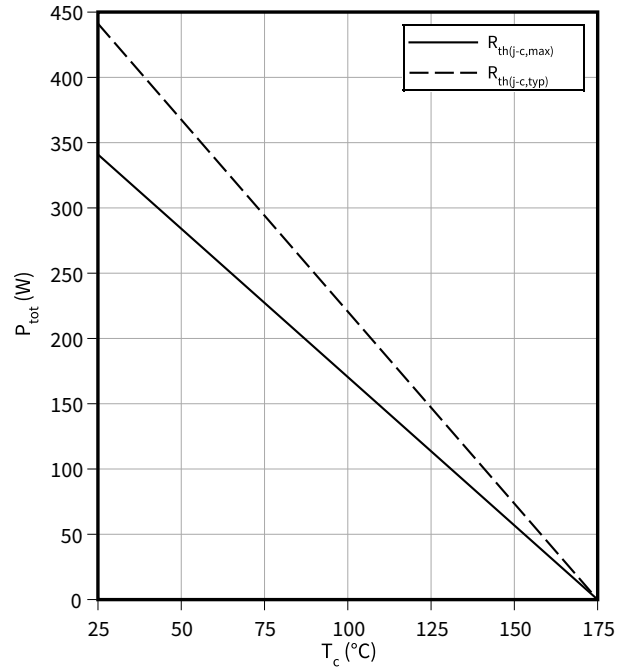

### Maximum DC drain to source current as a function of case temperature limited by bond wire

$$I_{DS} = f(T_c)$$

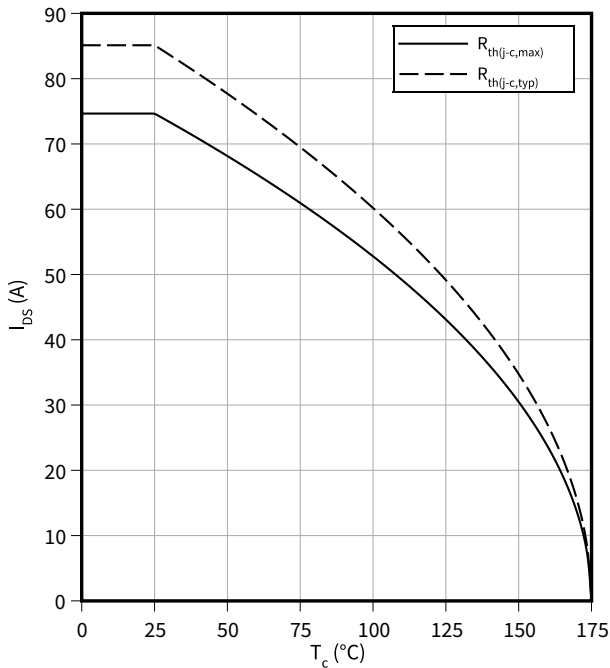

### Maximum source to drain current as a function of case temperature limited by bond wire

$$I_{SD} = f(T_c)$$

$$V_{GS} = 0 \text{ V}$$

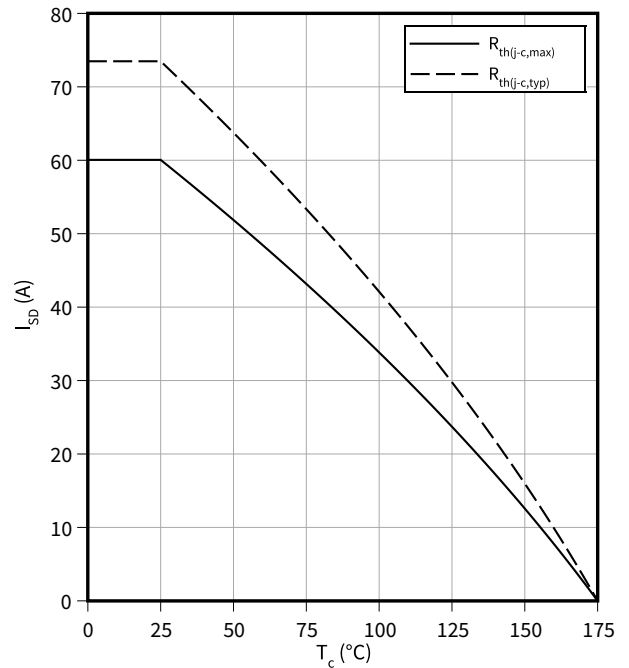



4 Characteristics diagrams

**Typical transfer characteristic**

$I_{DS} = f(V_{GS})$   
 $V_{DS} = 20\text{ V}, t_p = 20\ \mu\text{s}$

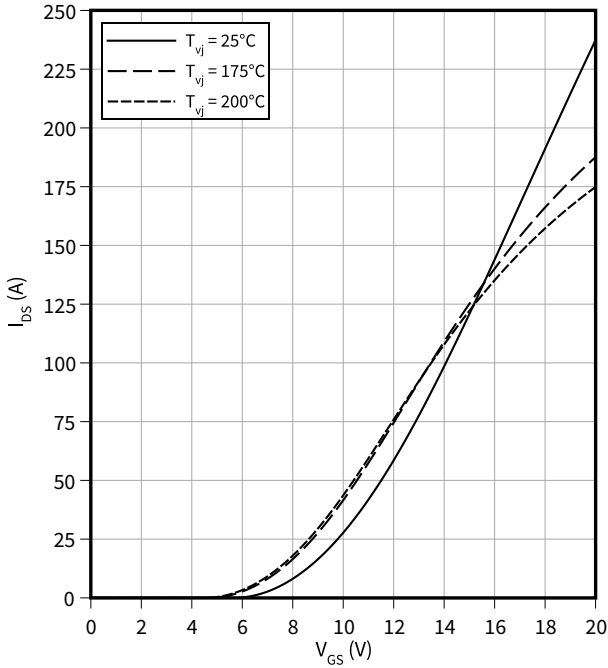

**Typical gate-source threshold voltage as a function of junction temperature**

$V_{GS(th)} = f(T_{vj})$   
 $I_D = 8.6\text{ mA}$

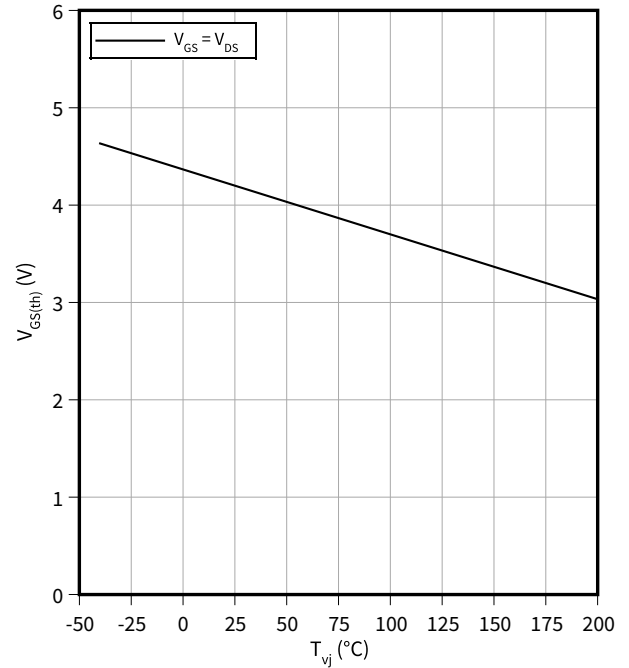

**Typical output characteristic,  $V_{GS}$  as parameter**

$I_{DS} = f(V_{DS})$   
 $T_{vj} = 25^\circ\text{C}, t_p = 20\ \mu\text{s}$

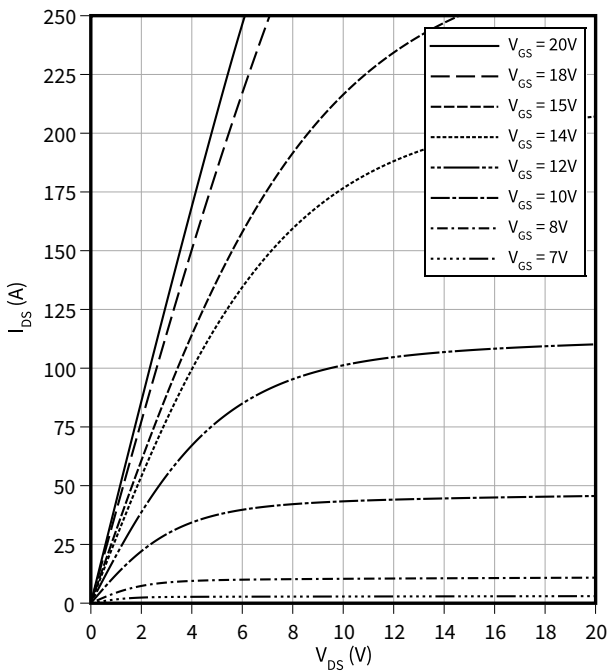

**Typical output characteristic,  $V_{GS}$  as parameter**

$I_{DS} = f(V_{DS})$   
 $T_{vj} = 175^\circ\text{C}, t_p = 20\ \mu\text{s}$

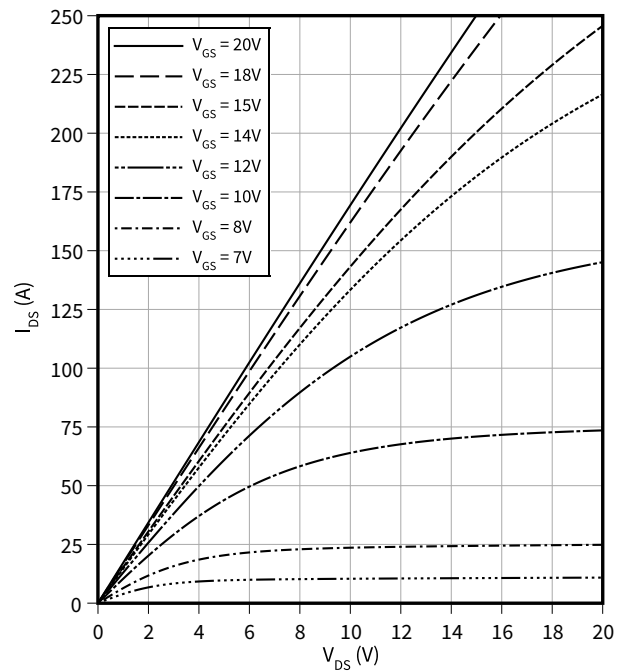

4 Characteristics diagrams

**Typical on-state resistance as a function of junction temperature**

$R_{DS(on)} = f(T_{vj})$   
 $I_D = 27.3 \text{ A}$

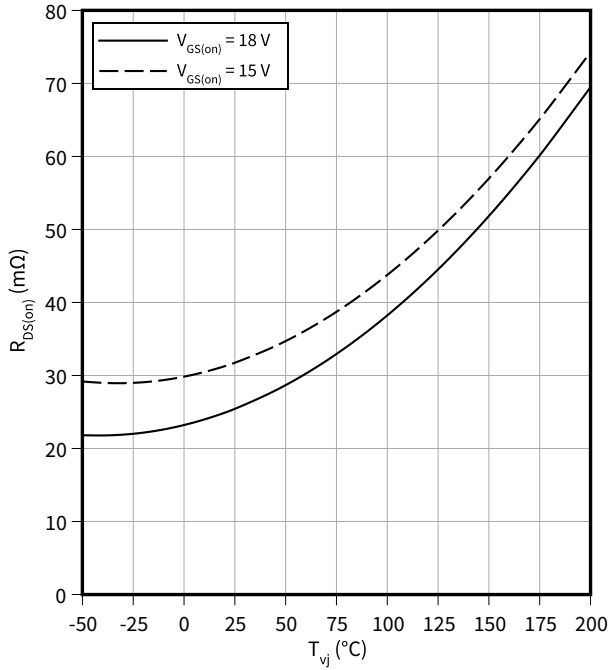

**Typical gate charge**

$V_{GS} = f(Q_G)$   
 $I_D = 27.3 \text{ A}, V_{DS} = 800 \text{ V}$

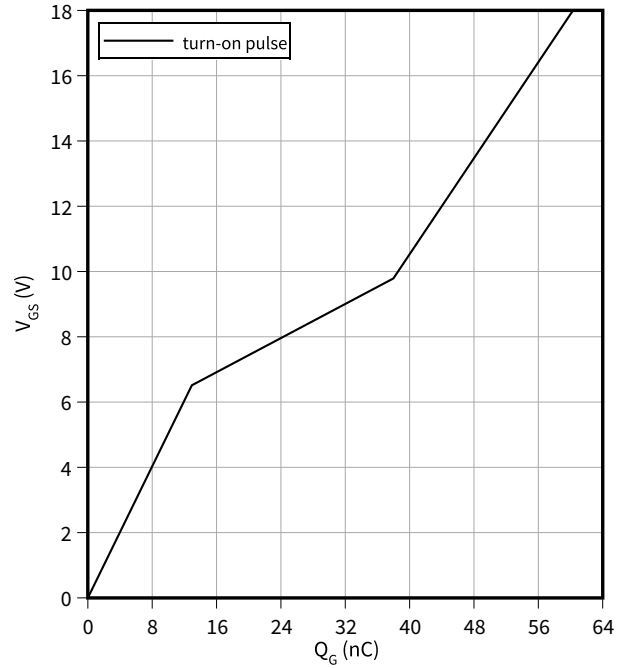

**Typical capacitance as a function of drain-source voltage**

$C = f(V_{DS})$   
 $f = 100 \text{ kHz}, V_{GS} = 0 \text{ V}$

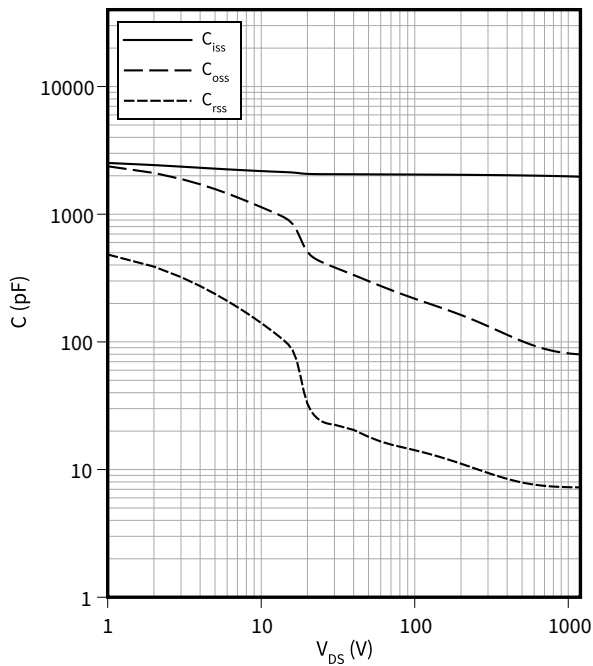

**Typical reverse drain voltage as function of junction temperature**

$V_{SD} = f(T_{vj})$   
 $I_{SD} = 27.3 \text{ A}, V_{GS} = 0 \text{ V}$

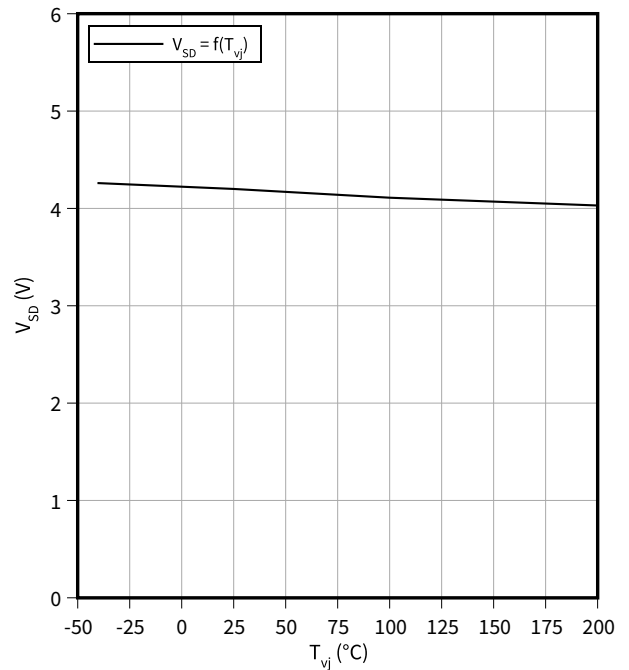

4 Characteristics diagrams

**Typical reverse drain current as function of reverse drain voltage,  $V_{GS}$  as parameter**

$I_{SD} = f(V_{SD})$   
 $T_{vj} = 25\text{ °C}$ ,  $t_p = 20\text{ }\mu\text{s}$

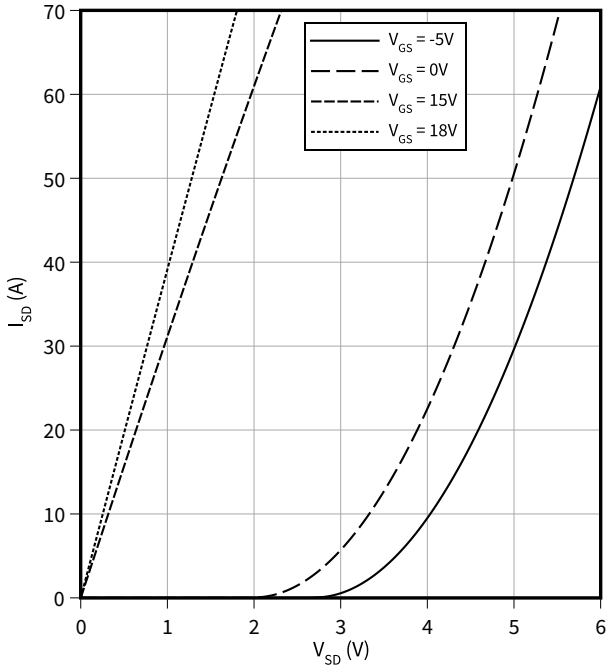

**Typical reverse drain current as function of reverse drain voltage,  $V_{GS}$  as parameter**

$I_{SD} = f(V_{SD})$   
 $T_{vj} = 175\text{ °C}$ ,  $t_p = 20\text{ }\mu\text{s}$

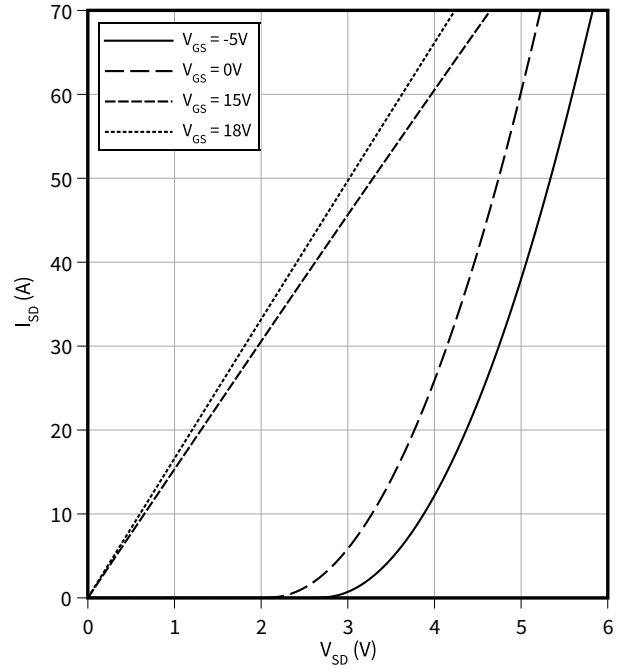

**Typical switching energy as a function of junction temperature, test circuit in Fig. F, 2nd device own body diode:  $V_{GS} = 0\text{ V}$**

$E = f(T_{vj})$   
 $V_{GS} = 0/18\text{ V}$ ,  $I_D = 27.3\text{ A}$ ,  $R_{G,ext} = 2.3\text{ }\Omega$ ,  $V_{DD} = 800\text{ V}$

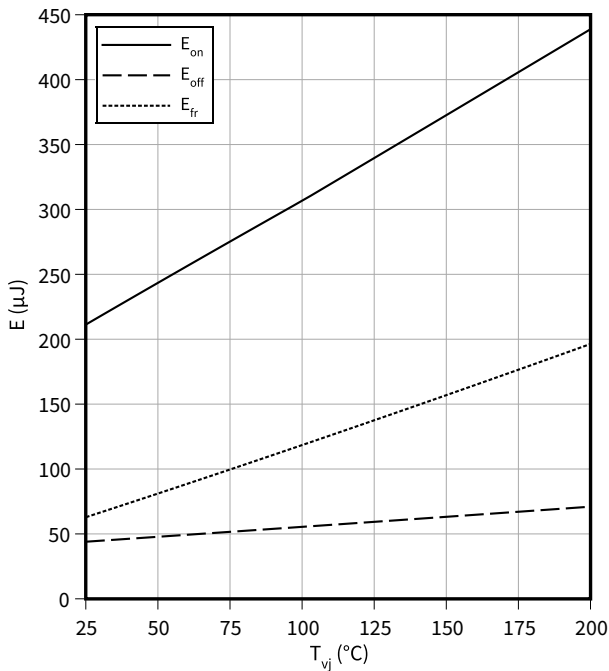

**Typical switching energy as a function of drain current, test circuit in Fig. F, 2nd device own body diode:  $V_{GS} = 0\text{ V}$**

$E = f(I_D)$   
 $V_{GS} = 0/18\text{ V}$ ,  $T_{vj} = 175\text{ °C}$ ,  $R_{G,ext} = 2.3\text{ }\Omega$ ,  $V_{DD} = 800\text{ V}$

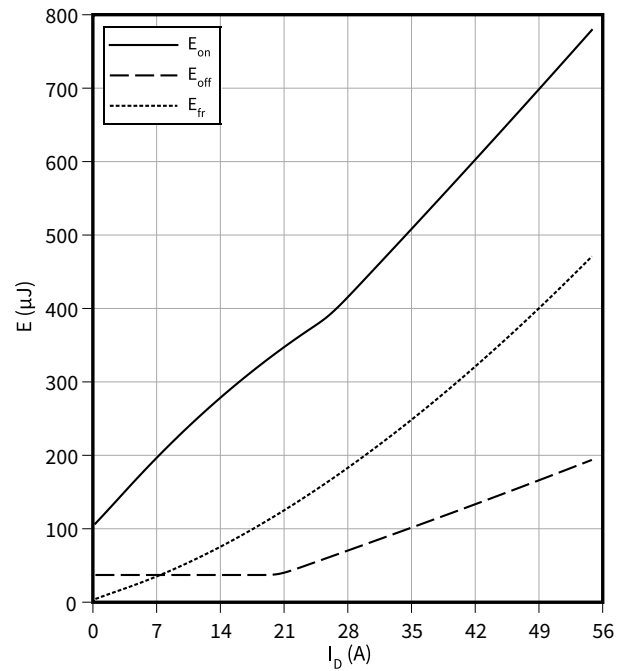

4 Characteristics diagrams

**Typical switching energy as a function of gate resistance, test circuit in Fig. F, 2nd device own body diode:  $V_{GS} = 0\text{ V}$**

$E = f(R_{G,ext})$

$V_{GS} = 0/18\text{ V}$ ,  $I_D = 27.3\text{ A}$ ,  $T_{vj} = 175\text{ °C}$ ,  $V_{DD} = 800\text{ V}$

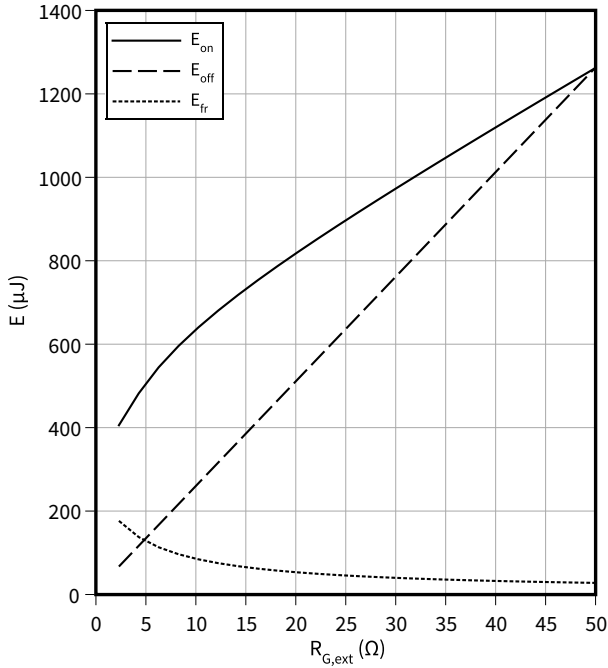

**Typical switching times as a function of gate resistance, test circuit in Fig. F, 2nd device own body diode:  $V_{GS} = 0\text{ V}$**

$t = f(R_{G,ext})$

$V_{GS} = 0/18\text{ V}$ ,  $I_D = 27.3\text{ A}$ ,  $T_{vj} = 175\text{ °C}$ ,  $V_{DD} = 800\text{ V}$

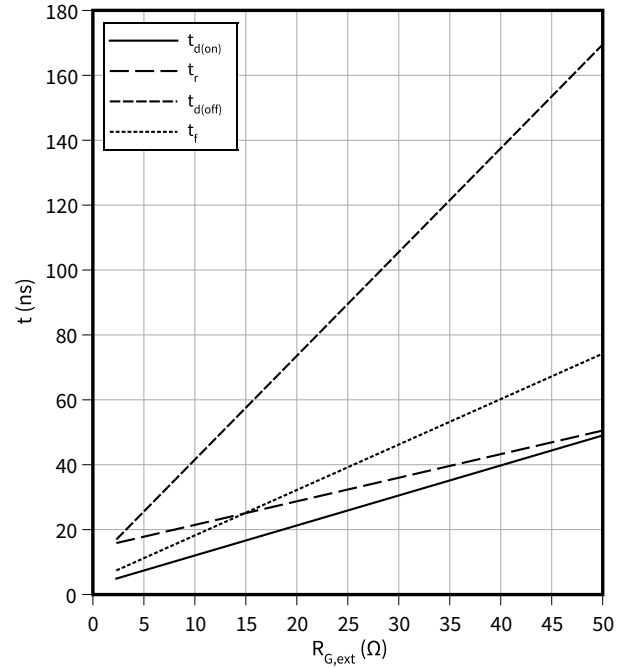

**Typical reverse recovery charge as a function of reverse drain current slope, test circuit in Fig. F, 2nd device own body diode:  $V_{GS} = 0\text{ V}$**

$Q_{fr} = f(di_{SD}/dt)$

$V_{GS} = 0/18\text{ V}$ ,  $I_{SD} = 27.3\text{ A}$ ,  $V_{DD} = 800\text{ V}$

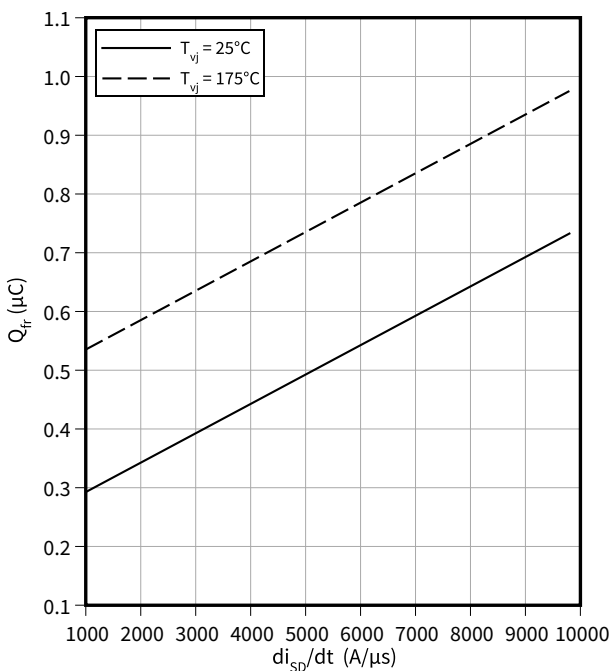

**Typical reverse recovery current as a function of reverse drain current slope, test circuit in Fig. F, 2nd device own body diode:  $V_{GS} = 0\text{ V}$**

$I_{frm} = f(di_{SD}/dt)$

$V_{GS} = 0/18\text{ V}$ ,  $I_{SD} = 27.3\text{ A}$ ,  $V_{DD} = 800\text{ V}$

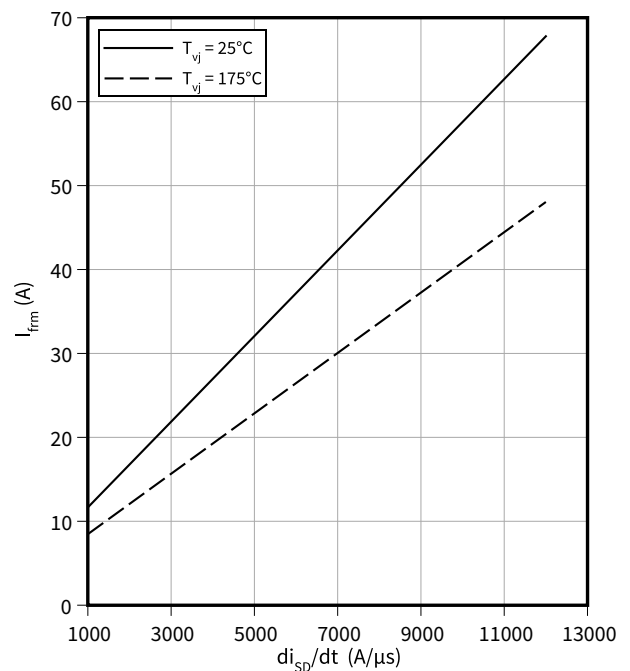

4 Characteristics diagrams

**Typical switching energy as a function of dead time / blanking time, test circuit in Fig. F, 2nd device own body diode:  $V_{GS} = -5\text{ V}$**

$E = f(t_{\text{dead}})$

$V_{GS} = 0/18\text{ V}$ ,  $I_D = 27.3\text{ A}$ ,  $T_{vj} = 175\text{ °C}$ ,  $R_{G,\text{ext}} = 2.3\ \Omega$

$V_{DD} = 800\text{ V}$

**Max. transient thermal impedance (MOSFET/diode)**

$Z_{\text{th}(j-c),\text{max}} = f(t_p)$

$D = t_p/T$

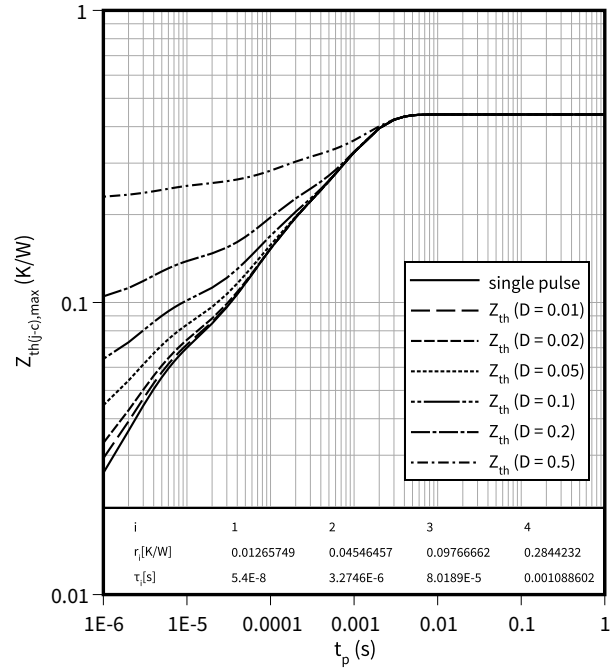
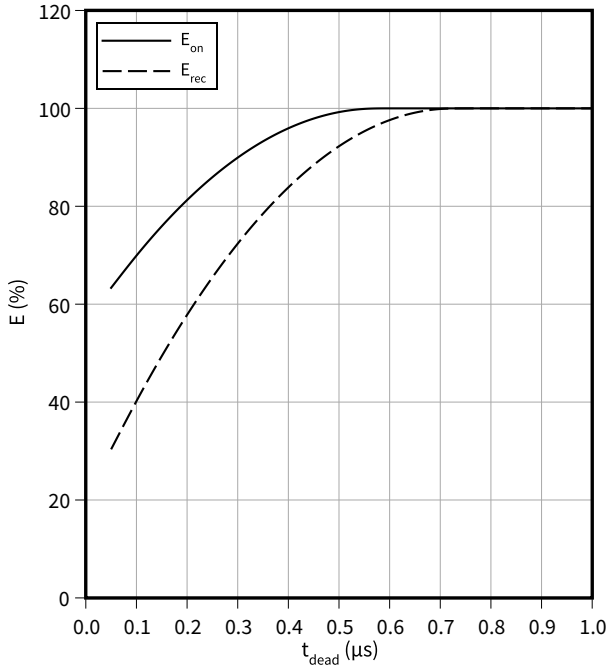

5 Package outlines

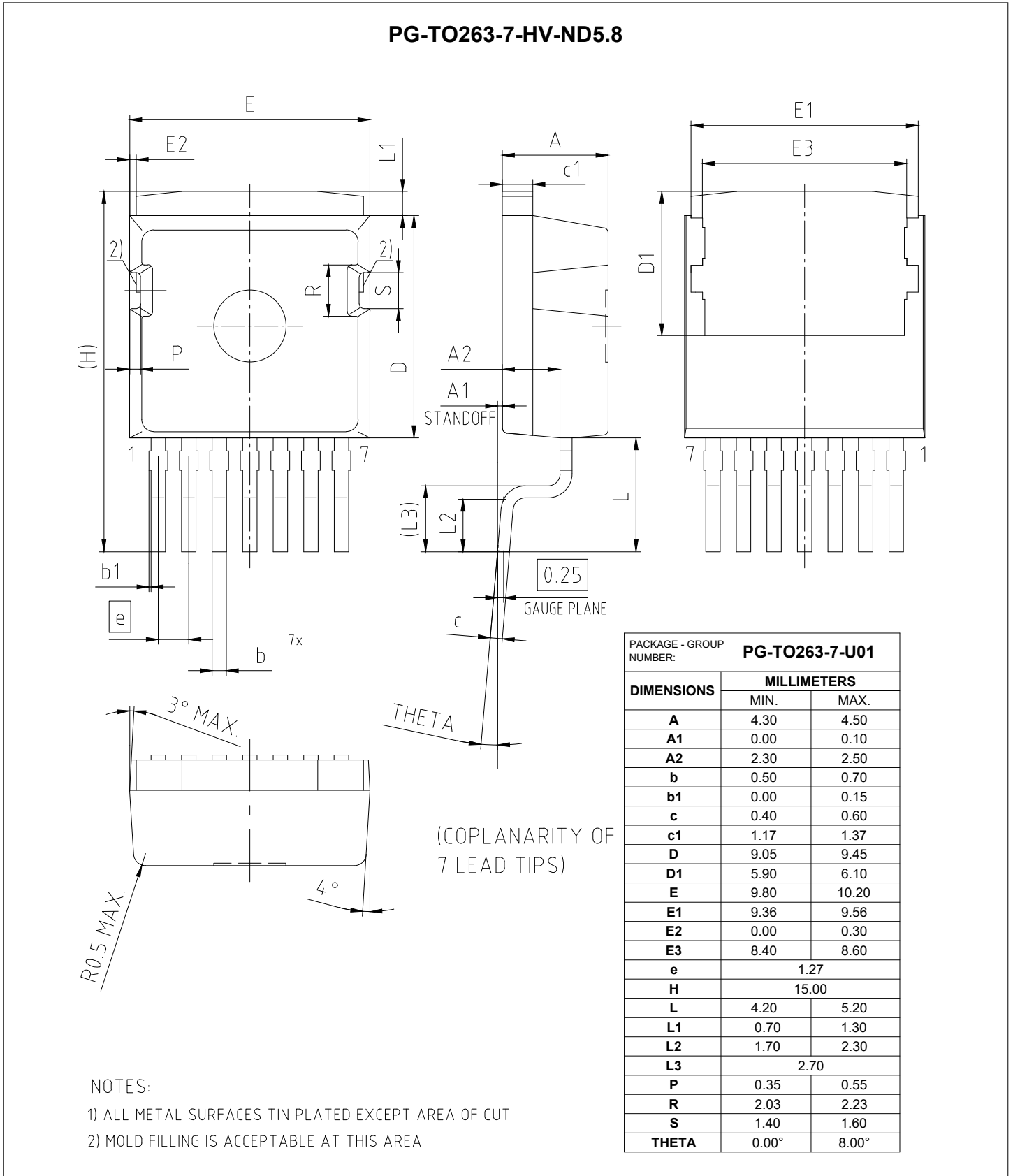

Figure 1

## 6 Testing conditions

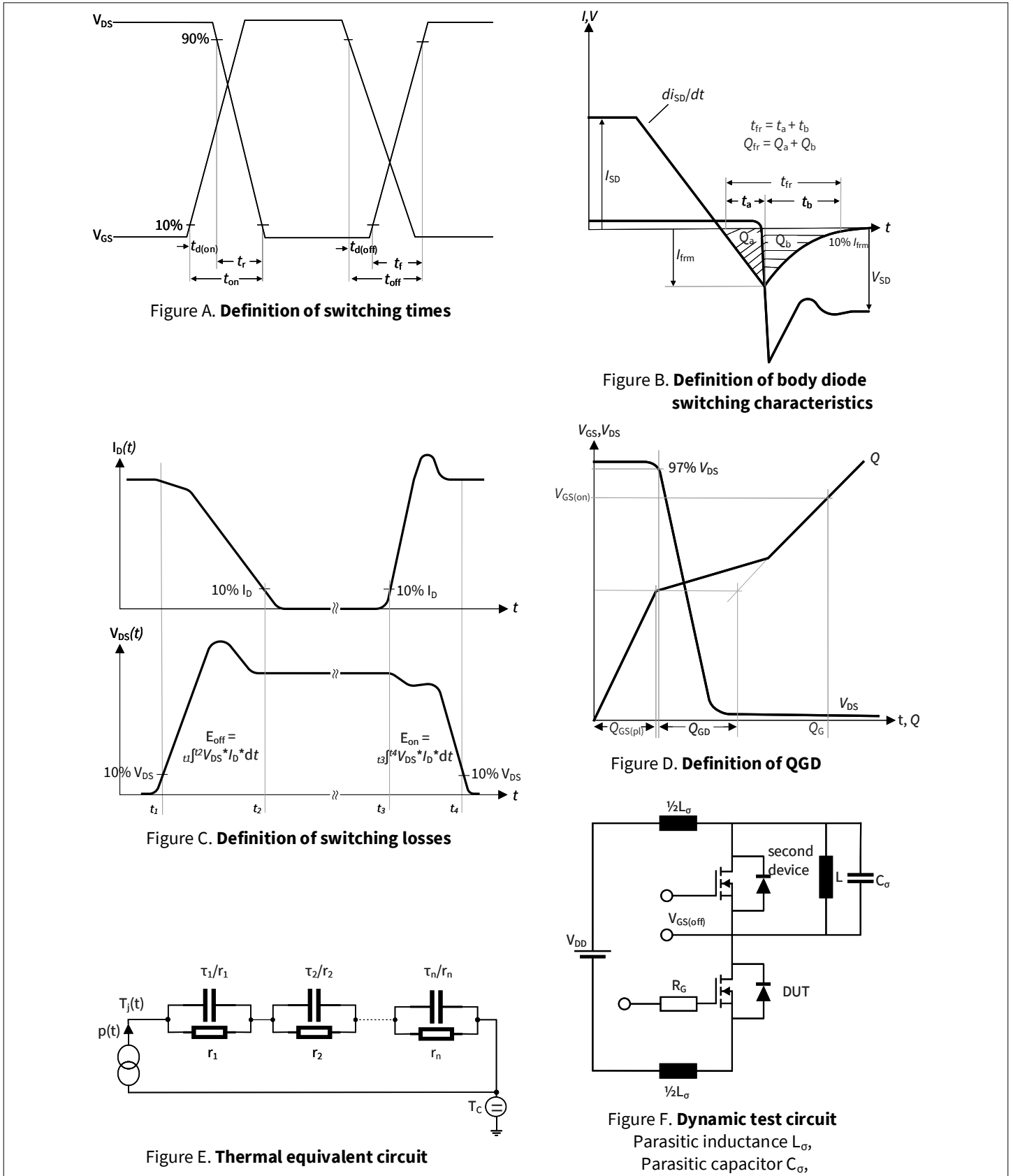

Figure 2

Revision history

## Revision history

Document revision	Date of release	Description of changes
0.10	2023-08-08	Preliminary datasheet
1.00	2023-09-29	Final datasheet
1.10	2024-01-11	Negative gate voltage values updated Resistance parameters updated Additional capacitance & charge values added E = f(t <sub>dead</sub> ) graph y-axis correction to percentage values Editorial changes



## Trademarks

All referenced product or service names and trademarks are the property of their respective owners.

**Edition 2024-01-12**

**Published by**

**Infineon Technologies AG**

**81726 Munich, Germany**

**© 2024 Infineon Technologies AG**

**All Rights Reserved.**

**Do you have a question about any aspect of this document?**

**Email: [erratum@infineon.com](mailto:erratum@infineon.com)**

**Document reference**

**IFX-ABH358-003**

## Important notice

The information given in this document shall in no event be regarded as a guarantee of conditions or characteristics ("Beschaffheitsgarantie").

With respect to any examples, hints or any typical values stated herein and/or any information regarding the application of the product, Infineon Technologies hereby disclaims any and all warranties and liabilities of any kind, including without limitation warranties of non-infringement of intellectual property rights of any third party.

In addition, any information given in this document is subject to customer's compliance with its obligations stated in this document and any applicable legal requirements, norms and standards concerning customer's products and any use of the product of Infineon Technologies in customer's applications.

The data contained in this document is exclusively intended for technically trained staff. It is the responsibility of customer's technical departments to evaluate the suitability of the product for the intended application and the completeness of the product information given in this document with respect to such application.

Please note that this product is not qualified according to the AEC Q100 or AEC Q101 documents of the Automotive Electronics Council.

## Warnings

Due to technical requirements products may contain dangerous substances. For information on the types in question please contact your nearest Infineon Technologies office.

Except as otherwise explicitly approved by Infineon Technologies in a written document signed by authorized representatives of Infineon Technologies, Infineon Technologies' products may not be used in any applications where a failure of the product or any consequences of the use thereof can reasonably be expected to result in personal injury.