

# RMOD360-UW Series ◊ Plug & Play E-Mobility

## 360W ◊ Ultra-Wide Input: 18-106VDC



### FEATURES

- Ultra wide input voltage range (18-106VDC)
- Operating temperature range: -40°C to +75°C
- Input reverse polarity protection
- Protection: input UVLO, output OCL, SCP, OVP, OTP
- Parallel operation capability
- Control ON/OFF function
- 2 years warranty



Dimensions (LxWxH): 190.0 x 76.0 x 44.0mm (7.48 x 2.99 x 1.73 inch)  
900g (1.98 lbs)

### APPLICATIONS



### SAFETY & EMC



### DESCRIPTION

The RMOD360-UW On-Board DC/DC converter is ideally for the use in all off-highway electric vehicles. This family is an extremely robust plug & play module with 360 Watts (240W), which generates the isolated  $V_{out} = 24.5VDC$  low voltage network from the traction battery level. The ultra wide input voltage range 18-106V covers all common battery voltages in this off-highway segment. Thanks to the waterproof and dust proof housing construction, the devices can directly be connected mechanically and thermally to the chassis (i.e. at any point on the vehicle) and operate reliably even under the most adverse conditions.

### SELECTION GUIDE

Part Number	Input Voltage Range [VDC]	Output Voltage nom. [VDC]	Output Current max. <sup>(1)</sup> [A]	Efficiency typ. [%]	Output Power max. <sup>(2)</sup> [W]
RMOD360-80-24.5SUW <sup>(3, 4)</sup>	18-106	24.5	15	89	360

Note1: Tested at  $V_{in} = 48VDC$  and full load at +25°C ambient

Note2: 360W at  $V_{in} = 27-106VDC$ , 240W max. when  $V_{in} < 27VDC$

### MODEL NUMBERING

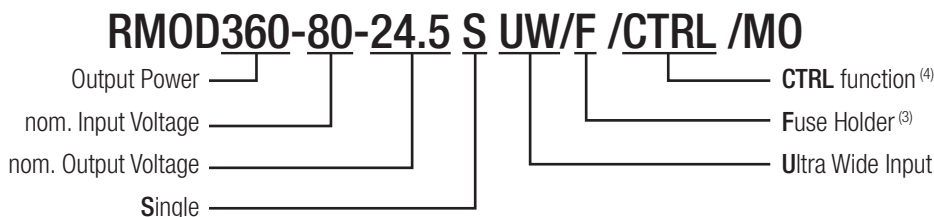

Note3: suffix "/F/MO" = with integrated fuse holder, without suffix = no internal fuse

Note4: suffix "/CTRL/MO" = with control function ("F/CTRL/MO" option is not available)

# RMOD360-UW Series ◊ Plug & Play E-Mobility

## 360W ◊ Ultra-Wide Input: 18-106VDC

**BASIC CHARACTERISTICS** (measured @  $T_{AMB}= 25^{\circ}C$ , nom.  $V_{IN}$ , full load and after warm-up unless otherwise stated)

Parameter	Conditions	Min.	Typ.	Max.
Input Voltage Range	nom. $V_{IN}= 24, 36, 48, 72, 80VDC$	18VDC		106VDC
	Extended range: 10min max.; refer to „Input Voltage Range“			126VDC
Under Voltage Lockout (UVLO)	DC-DC ON	16VDC	17VDC	18VDC
	DC-DC OFF	14VDC	15VDC	16VDC
	hysteresis	1VDC	2VDC	3VDC
Input Current	$V_{IN}= 18VDC$		15.5A	16A
Inrush Current	$V_{IN}= 36VDC$			10A
Quiescent Current	$V_{IN}= 24VDC$		235mA	265mA
	$V_{IN}= 48VDC$		105mA	130mA
	$V_{IN}= 72/80VDC$		70mA	100mA
Output Current	$V_{IN}= 18-27VDC$			9.6A
	$V_{IN}= 27-106VDC$			15A
Output Current Limit	$V_{IN}= 24VDC$	10A	12A	14A
	$V_{IN}= 36/48/72/80VDC$	16A	18.5A	22A
Minimum Load		0%		
Start-up Time	$V_{IN}= 48VDC$		700ms	1000ms
	$V_{IN}= 72VDC$		850ms	1200ms
Rise Time			60ms	100ms
ON/OFF CTRL (non-isolated to primary side)	DC-DC ON	CTRL Pin to $+V_{IN}$ or floating		
	DC-DC OFF	CTRL Pin to $-V_{IN}$		
Internal Operating Frequency			160kHz	
Output Ripple and Noise	20MHz BW		50mVp-p	100mVp-p
Maximum Capacitive Load	r.m.s.		20mV	50mV
Reflected Back Ripple Current	$V_{IN}= 48VDC$			0.6A
Maximum Capacitive Load	ESR>10mΩ			2000μF

### Input Voltage Range

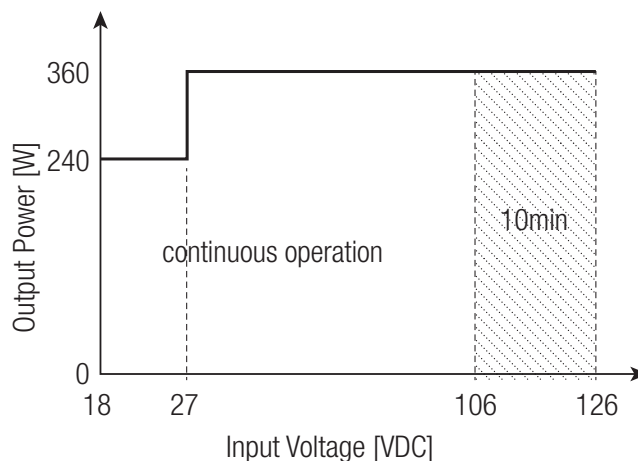

**BASIC CHARACTERISTICS** (measured @  $T_{AMB} = 25^{\circ}C$ , nom.  $V_{IN}$ , full load and after warm-up unless otherwise stated)

**Efficiency vs. Load**  
( $V_{IN} = 18-24VDC$ )

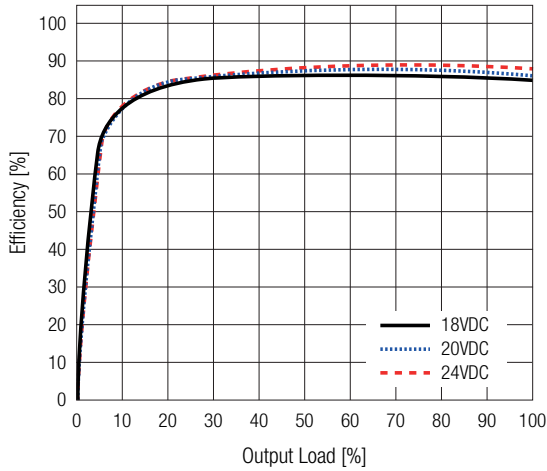

**Efficiency vs. Load**  
( $V_{IN} = 27-106VDC$ )

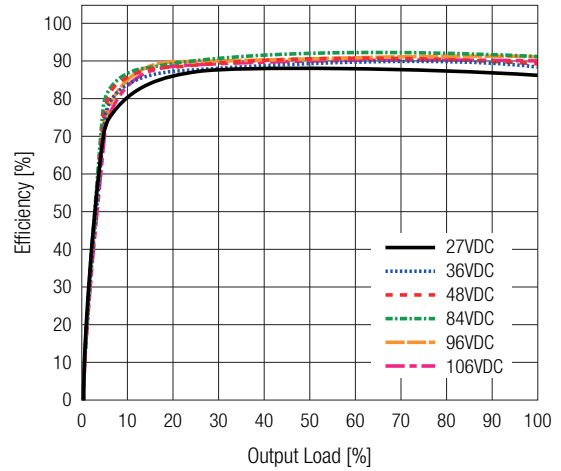

**Power Dissipation vs. Load**  
( $V_{IN} = 18-24VDC$ )

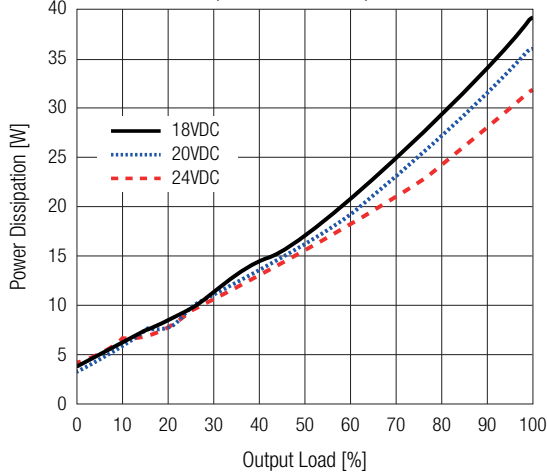

**Power Dissipation vs. Load**  
( $V_{IN} = 27-106VDC$ )

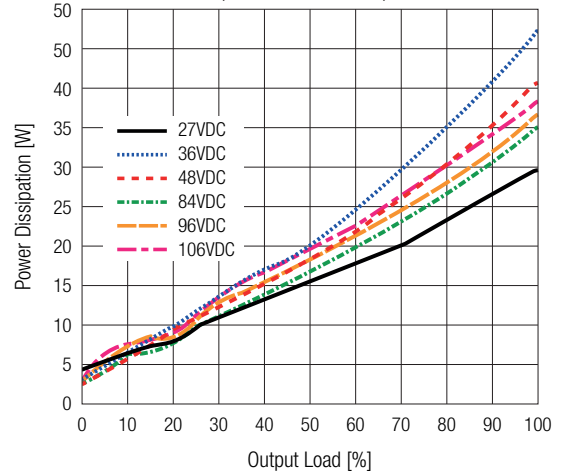

**REGULATIONS** (measured @  $T_{AMB} = 25^{\circ}C$ , nom.  $V_{IN}$ , full load and after warm-up unless otherwise stated)

Parameter	Conditions	Value
Output Accuracy		$\pm 1.0\%$ max.
Line Regulation	low line to high line, full load	0.1%
Load Regulation	10%-100% load	0.1% typ.
Transient Response	10-90% load, $V_{IN} = 16.8-137VDC$	0.5VDC
	recovery time	40ms typ.

**Deviation vs. Load**  
(nom.  $V_{IN}$ )

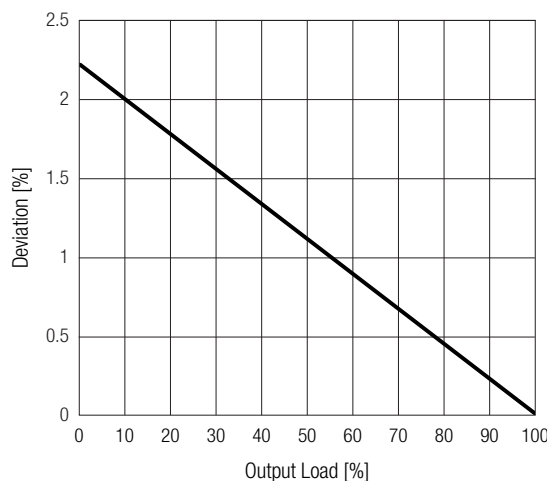

# RMOD360-UW Series ◊ Plug & Play E-Mobility

## 360W ◊ Ultra-Wide Input: 18-106VDC

**PROTECTIONS (measured @  $T_{AMB}= 25^{\circ}\text{C}$ , nom.  $V_{IN}$ , full load and after warm-up unless otherwise stated)**

Parameter	Type		Value
Internal Input Fuse	Ø6.35mm x 31.75mm ("F/MO" only)		250VDC/30A fast-acting fuse
Short Circuit Protection (SCP)			hiccup mode, auto recovery
Input Reverse Polarity Protection	active protected		-106VDC max.
Over Voltage Protection (OVP)	hiccup mode, auto recovery		27-34VDC
Over Voltage Category (OVC)			OVC I
Over Current Protection (OCP)	current limitation, automatic restart	$V_{IN}= 24\text{VDC}$	10-14A
		$V_{IN}= 36, 48, 72, 80\text{VDC}$	16-22A
Over Temperature Protection (OTP)	latch mode, measured on NTC		118°C
Isolation Voltage <sup>(6)</sup>	I/P to O/P, I/P to Case		2250VDC
	O/P to Case		550VDC
Isolation Resistance	I/P to O/P		10MΩ min.
Isolation Capacitance	I/P to O/P		7000pF max.
Insulation Grade			basic

Note6: For repeat Hi-Pot testing, reduce the time and/or the test voltage

**ENVIRONMENTAL (measured @  $T_{AMB}= 25^{\circ}\text{C}$ , nom.  $V_{IN}$ , full load and after warm-up unless otherwise stated)**

Parameter	Conditions	Value
Operating Ambient Temperature Range	with derating, refer to „Thermal Consideration“	-40°C to +75°C
Operating Altitude		5000m
Operating Humidity	non-condensing	95% RH max.
Pollution Degree		PD2
IP Rating	electronic part is encapsulated in IP67 level for all versions	IP20
Shock	50G, 3 planes	according to IEC 60068-2-27
Vibration	10G, 15~200Hz, 3 planes	according to IEC 60068-2-6
MTBF	$T_{AMB}= 25^{\circ}$ , 80% load	$675 \times 10^3$ hours

**Thermal Consideration**

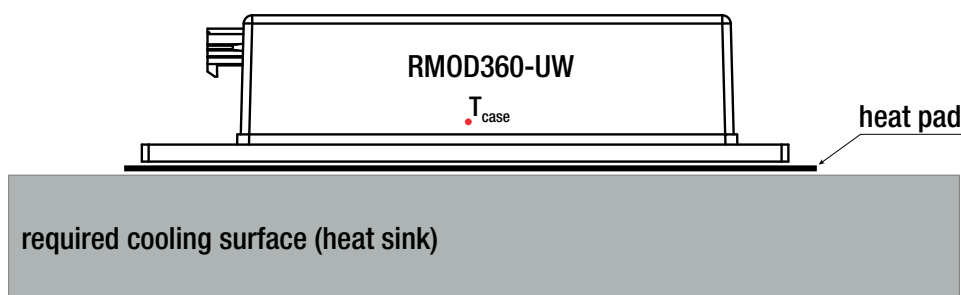

$T_{amb}$

natural convection 0.1m/s

The module can be used in enclosed applications, as long as the cooling is sufficient to keep the baseplate temperature below 70°C. The surrounding temperature should not exceed 75°C.

# RMOD360-UW Series ◊ Plug & Play E-Mobility

## 360W ◊ Ultra-Wide Input: 18-106VDC

**ENVIRONMENTAL** (measured @  $T_{AMB} = 25^{\circ}\text{C}$ , nom.  $V_{IN}$ , full load and after warm-up unless otherwise stated)

### Derating Graph

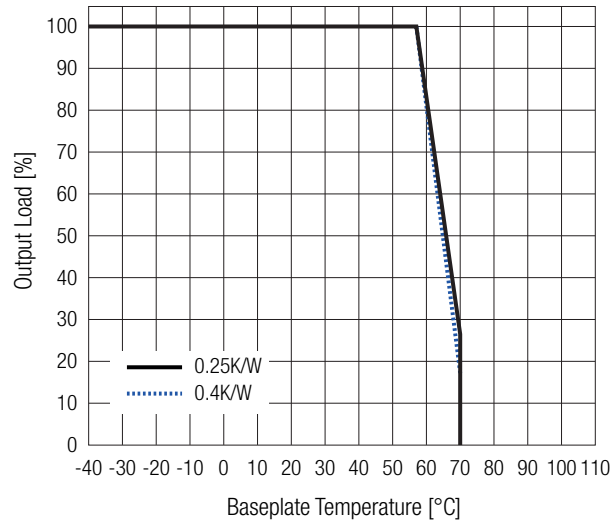

### SAFETY & CERTIFICATIONS

Certificate Type (Safety)	Report Number	Standard
Audio/Video, information and communication technology equipment - Part1: Safety requirements 2nd Edition	E224736	UL62368-1:2014 2nd Edition
		CAN/CSA-C22.2 No. 62368-1-14 2nd Edition
Audio/video, information and communication technology equipment. Safety requirements		EN62368-1:2014+A11:2017
RoHS2		RoHS 2011/65/EU + AM2015/863

EMC Compliance according to EN12895 (except RMOD360-80-24.5SUW/M0)	Conditions	Standard / Criterion
Industrial trucks - Electromagnetic compatibility		EN12895:2015
Electromagnetic compatibility (EMC) - Part 6-3: Generic standards - Emission standard for residential, commercial and light-industrial environments		EN61000-6-3:2007+A1:2011
ESD Electrostatic discharge immunity test	Air: $\pm 15\text{kV}$ Contact: $\pm 8\text{kV}$	IEC61000-4-2:2008, Criteria A EN61000-4-2:2009, Criteria A
Radiated, radio-frequency, electromagnetic field immunity test	20V/m (27-1000MHz), 3V/m (1000-2000MHz), 1V/m (2000-2700MHz)	IEC/EN61000-4-3:2006+A12:2010, Criteria A
Power Magnetic Field Immunity	DC 1000A/m, AC 50Hz 30A/m	IEC61000-4-8:2009, Criteria A EN61000-4-8:2010, Criteria A

### DIMENSION & PHYSICAL CHARACTERISTICS

Parameter	Type	Value
Material	case	polycarbonate
	baseplate	aluminum
Dimension (LxWxH)		190.0 x 76.0 x 44.0mm
		7.48 x 2.99 x 1.73 inch
Weight		900g typ.
		1.98 lbs

# RMOD360-UW Series ◊ Plug & Play E-Mobility

## 360W ◊ Ultra-Wide Input: 18-106VDC

### DIMENSION & PHYSICAL CHARACTERISTICS

#### Dimension Drawing (mm)

##### MOLEX Connector with CTRL function "/CTRL/MO"

#### Connector Information MOLEX 42819-5213

Pin #	Function	Compatible Connector
1	-V <sub>OUT</sub>	Housing
2	+V <sub>OUT</sub>	Molex 42816-0512
3	-V <sub>IN</sub>	Crimp Terminal
4	+V <sub>IN</sub>	Molex 42815-0042
5	CTRL	

FC= fixing center

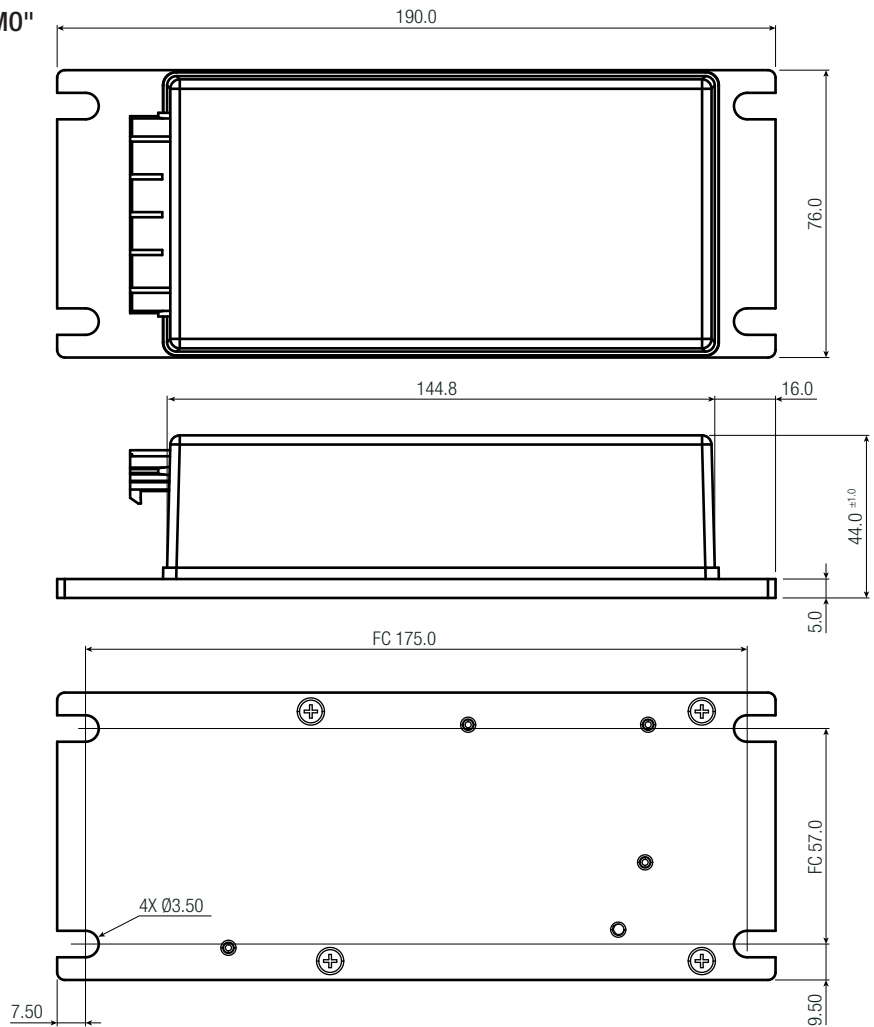
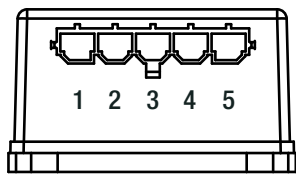

#### Dimension Drawing (mm)

##### MOLEX Connector with Fuse "/F/MO"

#### Connector Information MOLEX 42819-4213

Pin #	Function	Compatible Connector
1	-V <sub>OUT</sub>	Housing
2	+V <sub>OUT</sub>	Molex 42816-0412
3	-V <sub>IN</sub>	Crimp Terminal
4	+V <sub>IN</sub>	Molex 42815-0042

FC= fixing center

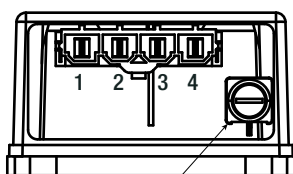

Fuse holder

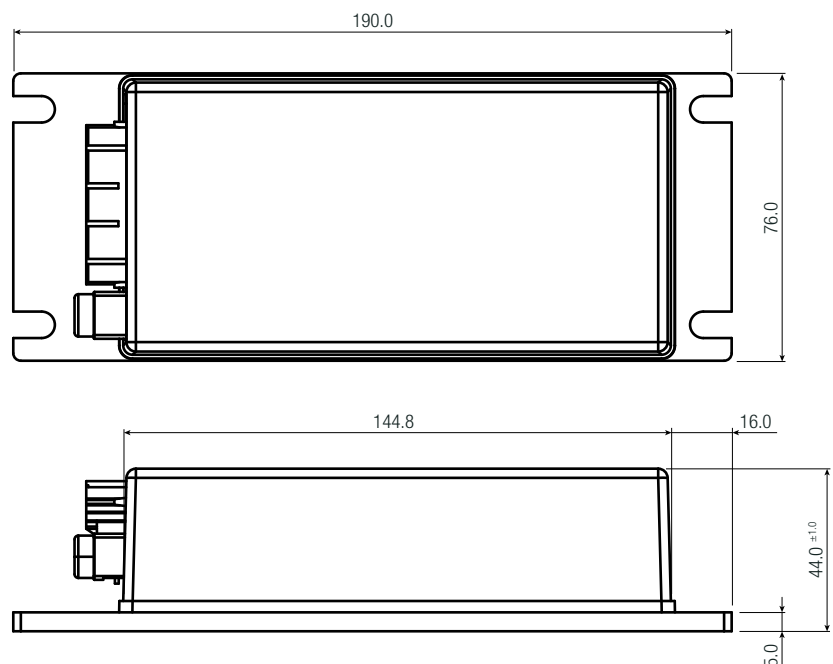

Tolerance:  
xx.x= ±0.5mm  
xx.xx= ±0.25mm

### INSTALLATION & APPLICATION

#### Parallel Operation

Parallel operation is possible with all combinations DC/DC converter versions providing they have the same rated input voltage.

Use the same wire length for each power supply (star connection) and energize all units at the same time to avoid triggering overload protection.

For operation with more than two power supplies in parallel operation, please contact RECOM technical support for advice.

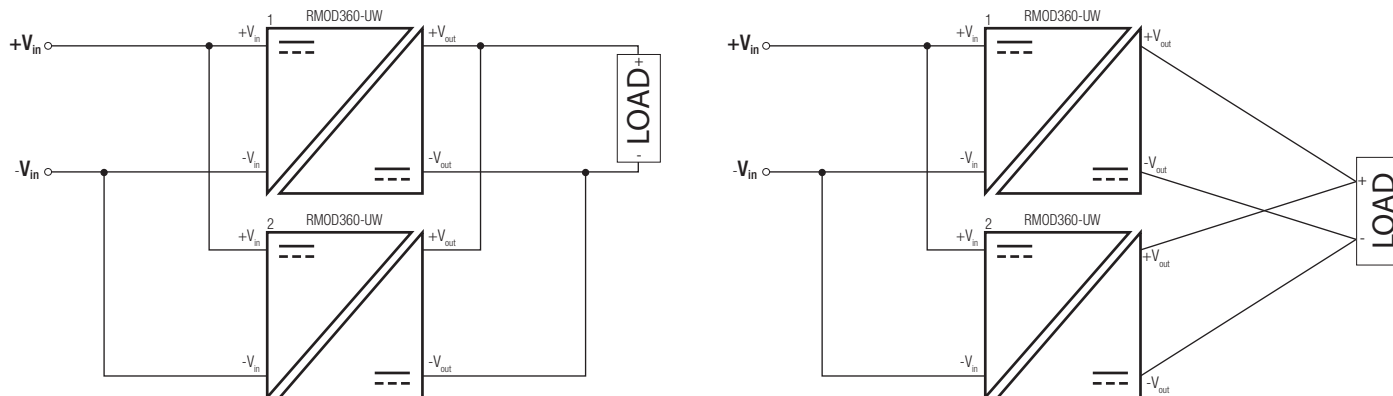

### PACKAGING INFORMATION

Parameter	Type	Value
Packaging Dimension (LxWxH)	cardboard box	490.0 x 375.0 x 126.0mm
Packaging Quantity		10pcs
Storage Temperature Range		-40°C to +125°C
Storage Humidity	non-condensing	95% RH max.

The product information and specifications may be subject to changes even without prior written notice. The product has been designed for various applications; its suitability lies in the responsibility of each customer. The products are not authorized for use in safety-critical applications without RECOM's explicit written consent. A safety-critical application is an application where a failure may reasonably be expected to endanger or cause loss of life, inflict bodily harm or damage property. The applicant shall indemnify and hold harmless RECOM, its affiliated companies and its representatives against any damage claims in connection with the unauthorized use of RECOM products in such safety-critical applications.