

MOSFET

600V CoolMOS™ SJ S7 Power Device

CoolMOS™ S7T enables the best price performance for low-frequency switching applications. The embedded temperature sensor increases junction temperature sensing accuracy and robustness while keeping an easy and seamless implementation. CoolMOS™ S7T is optimized for “static switching” and high current applications. The new temperature sensor enhances S7 features, allowing the best possible utilization of the power transistor.

Features

- Optimized price performance in low-frequency switching applications
- High pulse current capability
- Seamless diagnostics at the lowest system cost
- Temperature sense feature for protection and optimized thermal device utilization cost

Benefits

- Reduction of external sensing elements, hence a more compact design compared to electromechanical devices
- Increased system performance
- Minimized conduction losses (eliminate/reduce heat sink)
- Increased system performance
- More compact and more straightforward design
- Lower BOM or/and TCO over a prolonged lifetime
- More reliability and longer system lifetime

Potential applications

- Solid state relays and circuit breakers (PLC, Energy storage)
- Line rectification in high power/performance applications (Computing, Telecom, UPS and Solar)

Product validation

Fully qualified according to JEDEC for Industrial Applications

Please note: The source and sense source pins are not exchangeable. Their exchange might lead to malfunction. For paralleling 4pin MOSFET devices the placement of the gate resistor is generally recommended to be on the Driver Source instead of the Gate.

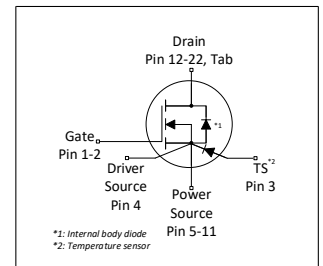
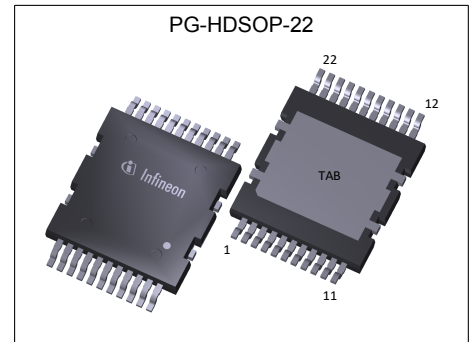

RoHS

Table 1 Key Performance Parameters

Parameter	Value	Unit
$R_{DS(on),max}$	17	mΩ
$Q_{g,typ}$	196	nC
V_{SD}	0.82	V
Pulsed I_{SD}, I_{DS}	488	A
ESD class (HBM)	2	JEDEC JS-001

Type / Ordering Code	Package	Marking	Related Links
IPQC60T017S7	PG-HDSOP-22	60I017S7	see Appendix A

Table of Contents

Description	1
Maximum ratings	3
Thermal characteristics	4
Electrical characteristics	5
Temperature Sensor parameters	7
Electrical characteristics diagrams	8
Test Circuits	12
Package Outlines	13
Appendix A	14
Revision History	15
Trademarks	15
Disclaimer	15

1 Maximum ratings

at $T_j = 25^\circ\text{C}$, unless otherwise specified

Table 2 Maximum MOSFET ratings

Parameter	Symbol	Values			Unit	Note / Test Condition
		Min.	Typ.	Max.		
Drain current rating ¹⁾	I_D	-	-	113 30	A	$T_C=25^\circ\text{C}$ $T_C=140^\circ\text{C}$
Pulsed drain current ²⁾	$I_{D,pulse}$	-	-	488	A	$T_C=25^\circ\text{C}$
Avalanche energy, single pulse	E_{AS}	-	-	375	mJ	$I_D=4.4\text{A}$; $V_{DD}=50\text{V}$; see table 11
Avalanche current, single pulse	I_{AS}	-	-	4.4	A	-
MOSFET dv/dt ruggedness ³⁾	dv/dt	-	-	20	V/ns	$V_{DS}=0\text{V to }300\text{V}$
Gate source voltage (static)	V_{GS}	-20	-	20	V	static
Gate source voltage (dynamic)	V_{GS}	-30	-	30	V	AC ($f>1\text{ Hz}$)
Power dissipation	P_{tot}	-	-	500	W	$T_C=25^\circ\text{C}$
Storage temperature	T_{stg}	-55	-	150	$^\circ\text{C}$	-
Operating junction temperature ¹⁾	T_j	-55	-	150	$^\circ\text{C}$	-
Extended operating junction temperature	T_j	150	-	175	$^\circ\text{C}$	$\leq 50\text{ h}$ in the application lifetime
Mounting torque	-	-	-	n.a.	Ncm	-
Diode forward current rating	I_S	-	-	30	A	$T_C=140^\circ\text{C}$ Current is limited by $T_{j,max} = 150^\circ\text{C}$; Lower case temp does increase current capability
Diode pulse current ¹⁾	$I_{S,pulse}$	-	-	488	A	$T_C=25^\circ\text{C}$
Reverse diode dv/dt ⁴⁾	dv/dt	-	-	5	V/ns	$V_{DS}=0\text{ to }300\text{V}$, $I_{SD}\leq 29\text{A}$, $T_j=25^\circ\text{C}$ see table 9
Maximum diode commutation speed	di/dt	-	-	800	A/ μs	$V_{DS}=0\text{ to }300\text{V}$, $I_{SD}\leq 29\text{A}$, $T_j=25^\circ\text{C}$ see table 9
Insulation withstand voltage	V_{ISO}	-	-	n.a.	V	-

¹⁾ Please consider the App Note: 600 V CoolMOSTM S7 with Temperature Sense for high delta T_j usage

²⁾ Pulse width t_p limited by $T_{j,max}$

³⁾ The dv/dt has to be limited by appropriate gate resistor

⁴⁾ Identical low side and high side switch

2 Thermal characteristics

Table 3 Thermal characteristics

Parameter	Symbol	Values			Unit	Note / Test Condition
		Min.	Typ.	Max.		
Thermal resistance, junction - case	R_{thJC}	-	-	0.25	°C/W	-
Thermal resistance, junction - ambient	R_{thJA}	-	-	62	°C/W	device on PCB, minimal footprint
Thermal resistance, junction - ambient for SMD version	R_{thJA}	-	45	55	°C/W	Device on 40mm*40mm*1.5mm epoxy PCB FR4 with 6cm ² (one layer, 70µm thickness) copper area. Tap exposed to air. PCB is vertical without air stream cooling.
Soldering temperature, reflow soldering allowed	T_{sold}	-	-	260	°C	reflow MSL1

3 Electrical characteristics

at $T_j=25^\circ\text{C}$, unless otherwise specified

Table 4 Static characteristics

For applications with applied blocking voltage >420V, it is required that the customer evaluates the impact of cosmic radiation effect in early design phase and contacts the Infineon sales office for the necessary technical support by Infineon

Parameter	Symbol	Values			Unit	Note / Test Condition
		Min.	Typ.	Max.		
Drain-source breakdown voltage	$V_{(BR)DSS}$	600	-	-	V	$V_{GS}=0V, I_D=1mA$
Gate threshold voltage	$V_{(GS)th}$	3.5	4.0	4.5	V	$V_{DS}=V_{GS}, I_D=1.88mA$
Zero gate voltage drain current	I_{DSS}	-	-	6	μA	$V_{DS}=600V, V_{GS}=0V, T_j=25^\circ C$ $V_{DS}=600V, V_{GS}=0V, T_j=150^\circ C$
Gate-source leakage current	I_{GSS}	-	-	100	nA	$V_{GS}=20V, V_{DS}=0V$
Drain-source on-state resistance	$R_{DS(on)}$	-	0.015	0.017	Ω	$V_{GS}=12V, I_D=29A, T_j=25^\circ C$ $V_{GS}=12V, I_D=29A, T_j=150^\circ C$
Gate resistance	R_G	-	0.8	-	Ω	$f=1MHz, \text{open drain}$

Table 5 Dynamic characteristics

Parameter	Symbol	Values			Unit	Note / Test Condition
		Min.	Typ.	Max.		
Input capacitance	C_{iss}	-	7370	-	pF	$V_{GS}=0V, V_{DS}=300V, f=250kHz$
Output capacitance	C_{oss}	-	116	-	pF	$V_{GS}=0V, V_{DS}=300V, f=250kHz$
Effective output capacitance, energy related ¹⁾	$C_{o(er)}$	-	396	-	pF	$V_{GS}=0V, V_{DS}=0 \text{ to } 300V$
Effective output capacitance, time related ²⁾	$C_{o(tr)}$	-	3506	-	pF	$I_D=\text{constant}, V_{GS}=0V, V_{DS}=0 \text{ to } 300V$
Output charge	Q_{oss}	-	1051	-	nC	$V_{GS}=0V, V_{DS}=0 \text{ to } 300V$
Turn-on delay time	$t_{d(on)}$	-	30	-	ns	$V_{DD}=300V, V_{GS}=13V, I_D=29A, R_G=4.5\Omega; \text{ see table 9}$
Rise time	t_r	-	12	-	ns	$V_{DD}=300V, V_{GS}=13V, I_D=29A, R_G=4.5\Omega; \text{ see table 9}$
Turn-off delay time	$t_{d(off)}$	-	160	-	ns	$V_{DD}=300V, V_{GS}=13V, I_D=29A, R_G=4.5\Omega; \text{ see table 9}$
Fall time	t_f	-	9	-	ns	$V_{DD}=300V, V_{GS}=13V, I_D=29A, R_G=4.5\Omega; \text{ see table 9}$

Table 6 Gate charge characteristics

Parameter	Symbol	Values			Unit	Note / Test Condition
		Min.	Typ.	Max.		
Gate to source charge	Q_{gs}	-	40	-	nC	$V_{DD}=300V, I_D=29A, V_{GS}=0 \text{ to } 12V$
Gate to drain charge	Q_{gd}	-	65	-	nC	$V_{DD}=300V, I_D=29A, V_{GS}=0 \text{ to } 12V$
Gate charge total	Q_g	-	196	-	nC	$V_{DD}=300V, I_D=29A, V_{GS}=0 \text{ to } 12V$
Gate plateau voltage	$V_{plateau}$	-	5.4	-	V	$V_{DD}=300V, I_D=29A, V_{GS}=0 \text{ to } 12V$

¹⁾ $C_{o(er)}$ is a fixed capacitance that gives the same stored energy as C_{oss} while V_{DS} is rising from 0 to 300V

²⁾ $C_{o(tr)}$ is a fixed capacitance that gives the same charging time as C_{oss} while V_{DS} is rising from 0 to 300V

Table 7 Reverse diode characteristics

Parameter	Symbol	Values			Unit	Note / Test Condition
		Min.	Typ.	Max.		
Diode forward voltage	V_{SD}	-	0.82	-	V	$V_{GS}=0V, I_F=29A, T_j=25^\circ C$
Reverse recovery time	t_{rr}	-	490	-	ns	$V_R=300V, I_F=29A, di_F/dt=100A/\mu s$; see table 8
Reverse recovery charge	Q_{rr}	-	11.8	-	μC	$V_R=300V, I_F=29A, di_F/dt=100A/\mu s$; see table 8
Peak reverse recovery current	I_{rrm}	-	52	-	A	$V_R=300V, I_F=29A, di_F/dt=100A/\mu s$; see table 8

4 Temperature Sensor parameters

at $T_j=25^\circ\text{C}$, unless otherwise specified

Table 8 Maximum ratings

Parameter	Symbol	Values			Unit	Note / Test Condition
		Min.	Typ.	Max.		
Repetitive Peak Reverse Voltage	V_{RRM}	-	-	15	V	$I_R = 100 \mu\text{A}$
Sensor forward current	I_F	-	-	5	mA	-
Repetitive peak forward current	I_{F_pulse}	-	-	25	mA	$t_{pulse} = 1 \text{ ms}$, $T_{period} = 10 \text{ ms}$
Non-repetitive peak forward current	I_{FSM}	-	-	1.5 0.2 0.1	A	$T_C = 25^\circ\text{C}$, $t_{pulse} = 1 \mu\text{s}$ $T_C = 25^\circ\text{C}$, $t_{pulse} = 1 \text{ ms}$ $T_C = 25^\circ\text{C}$, $t_{pulse} = 1 \text{ s}$
Junction Temperature	T_j	-	-	185	$^\circ\text{C}$	$t < 50\text{h}$, Sensor only

Table 9 Electrical characteristics

Parameter	Symbol	Values			Unit	Note / Test Condition
		Min.	Typ.	Max.		
Sensor forward voltage ¹⁾	V_{F_25}	1.5601 - - 2.0665	1.6019 1.8103 1.9806 2.0966	1.6436 - - 2.1266	V	$T_j = 25^\circ\text{C}$, $I_F = 10 \mu\text{A}$ $T_j = 25^\circ\text{C}$, $I_F = 50 \mu\text{A}$ $T_j = 25^\circ\text{C}$, $I_F = 200 \mu\text{A}$ $T_j = 25^\circ\text{C}$, $I_F = 500 \mu\text{A}$
Sensor forward voltage temperature coefficient	TC	- - - -	5.9644 5.5880 5.2287 5.0135	- - - -	mV/K	$25^\circ\text{C} \leq T_j \leq 175^\circ\text{C}$, $I_F = 10 \mu\text{A}$ $25^\circ\text{C} \leq T_j \leq 175^\circ\text{C}$, $I_F = 50 \mu\text{A}$ $25^\circ\text{C} \leq T_j \leq 175^\circ\text{C}$, $I_F = 200 \mu\text{A}$ $25^\circ\text{C} \leq T_j \leq 175^\circ\text{C}$, $I_F = 500 \mu\text{A}$
Sensor forward voltage	V_{F_175}	0.6655 - - 1.3144	0.7072 0.9721 1.1963 1.3445	0.7490 - - 1.3746	V	$T_j = 175^\circ\text{C}$, $I_F = 10 \mu\text{A}$ $T_j = 175^\circ\text{C}$, $I_F = 50 \mu\text{A}$ $T_j = 175^\circ\text{C}$, $I_F = 200 \mu\text{A}$ $T_j = 175^\circ\text{C}$, $I_F = 500 \mu\text{A}$
Reverse leakage current	I_R	- -	- -	1 20	μA	$V_R = 10\text{V}$, $T_j = 25^\circ\text{C}$ $V_R = 10\text{V}$, $T_j = 175^\circ\text{C}$
Sensor G Capacitance	C_{GTS}	-	4.2	-	pF	$f = 1 \text{ MHz}$, $I_F = 50 \mu\text{A}$
Sensor Capacitance	C_{STS}	-	4.8	-	pF	$f = 1 \text{ MHz}$, $I_F = 50 \mu\text{A}$
Anode-Drain Capacitance	C_{DTS}	-	0.5	-	pF	$f = 1 \text{ MHz}$, $V_{DS} = 0 \text{ V}$

¹⁾ Specified by Design and not tested

5 Electrical characteristics diagrams

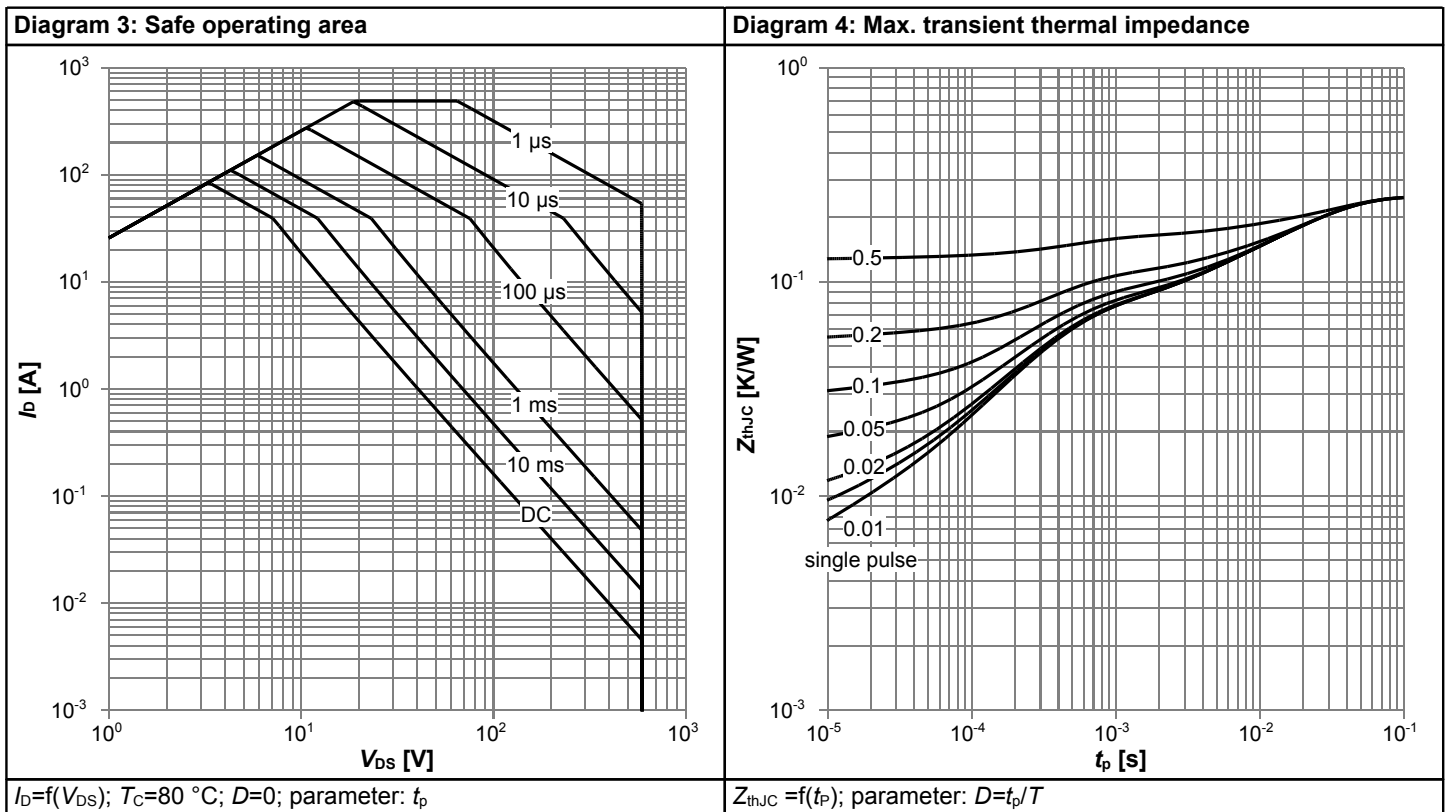
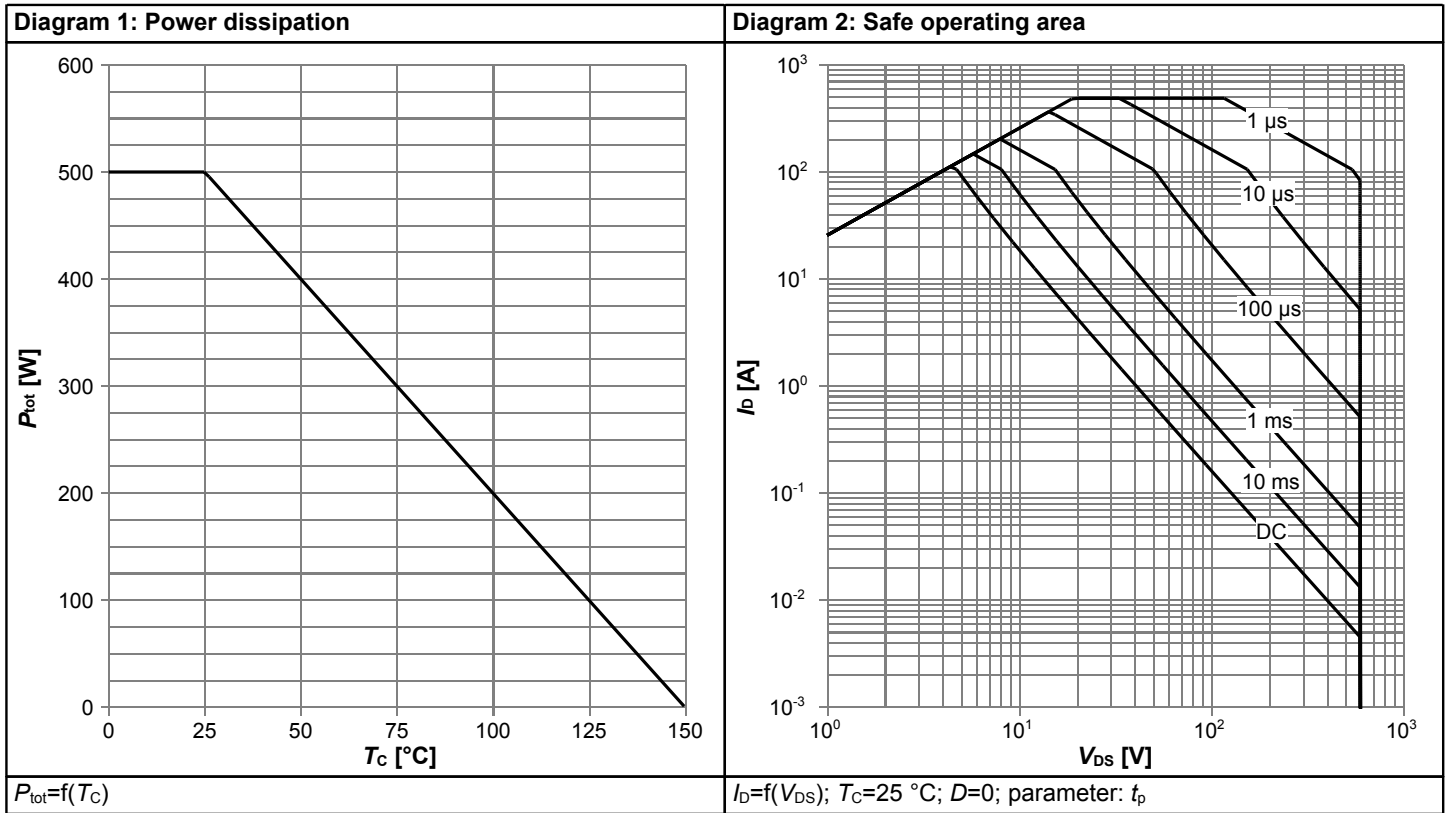
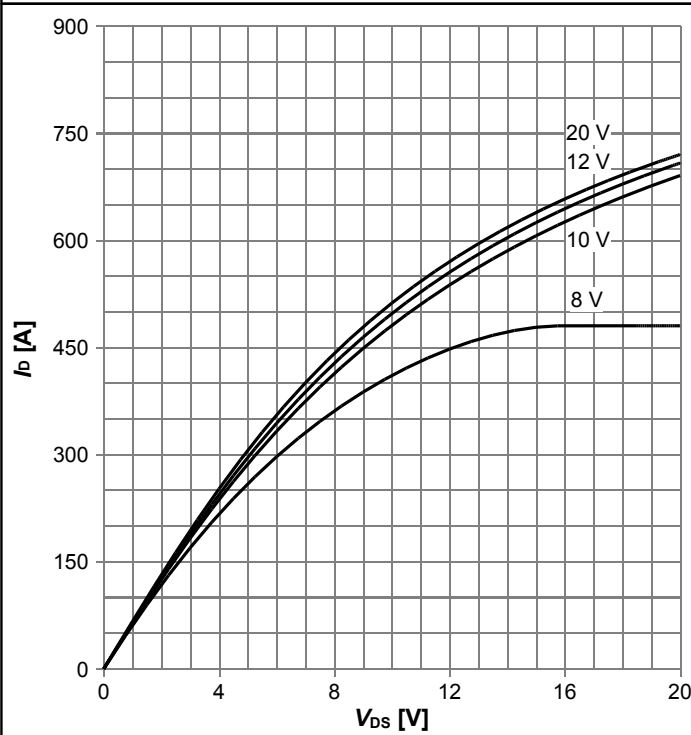
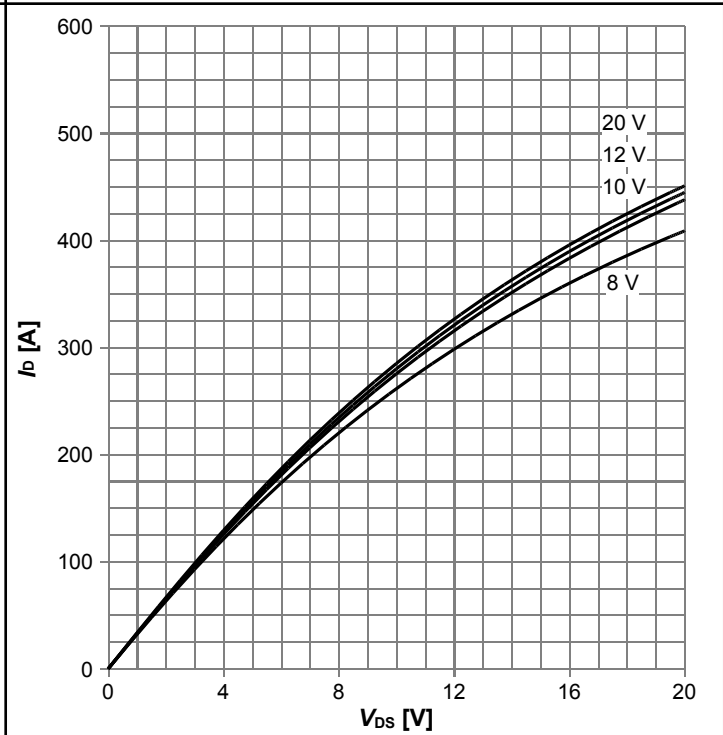

Diagram 5: Typ. output characteristics



$I_D=f(V_{DS}); T_j=25\text{ °C};$ parameter: V_{GS}

Diagram 6: Typ. output characteristics



$I_D=f(V_{DS}); T_j=125\text{ °C};$ parameter: V_{GS}

Diagram 7: Typ. drain-source on-state resistance

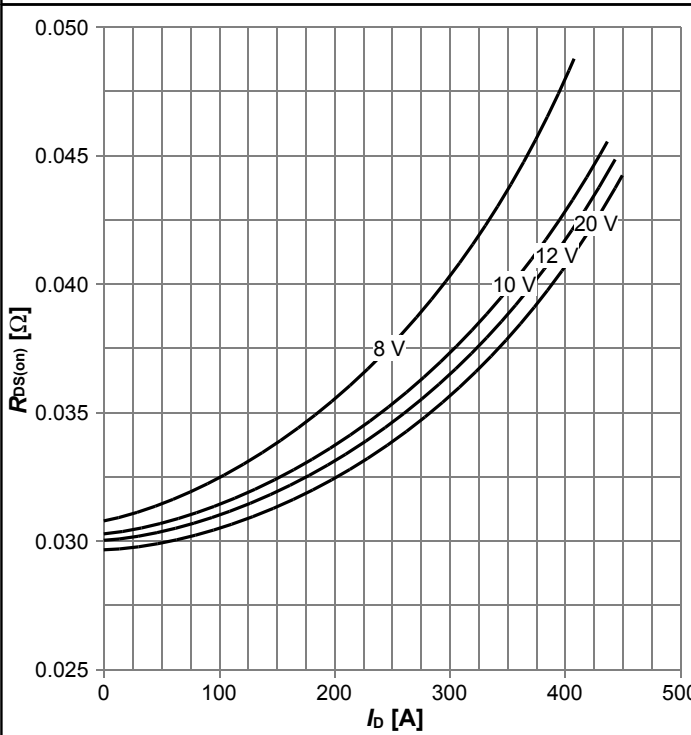

$R_{DS(on)}=f(I_D); T_j=125\text{ °C};$ parameter: V_{GS}

Diagram 8: Drain-source on-state resistance

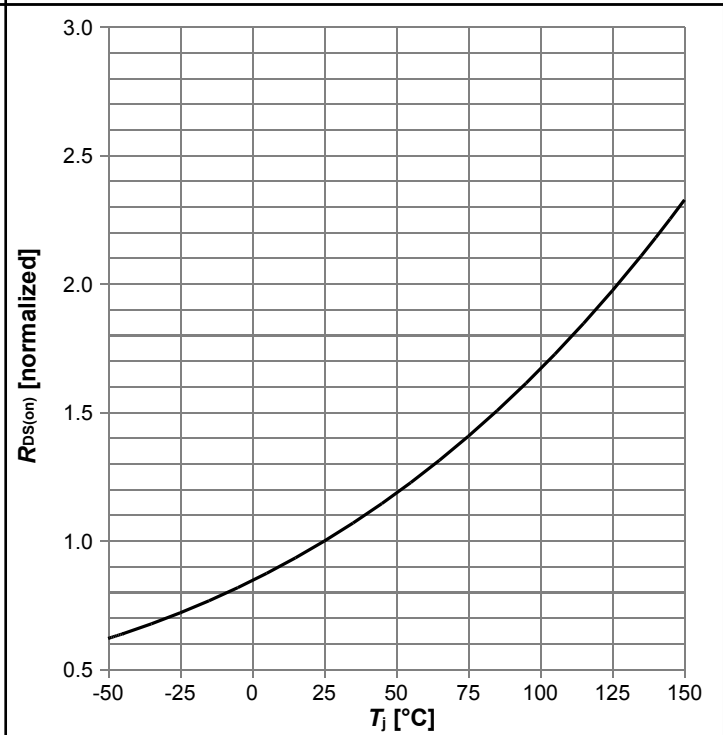

$R_{DS(on)}=f(T_j); I_D=29\text{ A}; V_{GS}=12\text{ V}$

Diagram 9: Typ. transfer characteristics

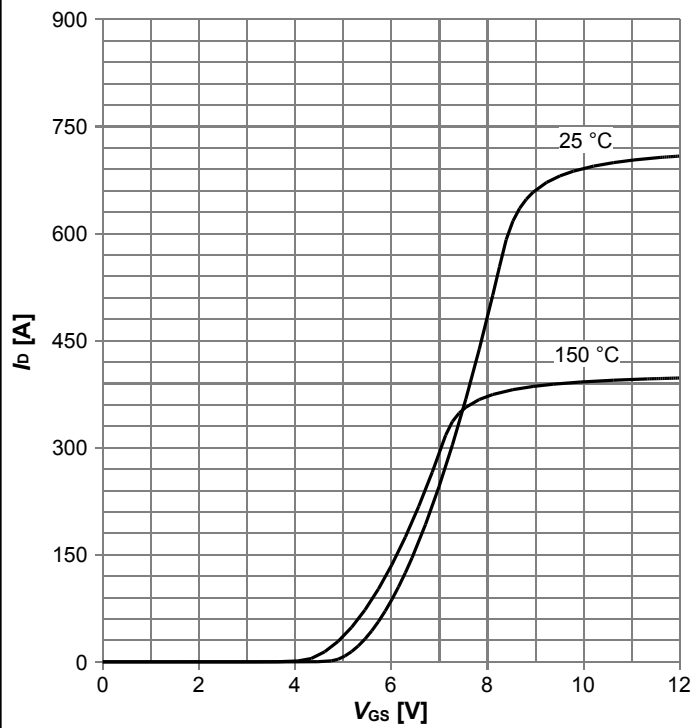

$I_D = f(V_{GS}); V_{DS} = 20V; \text{parameter: } T_j$

Diagram 10: Typ. gate charge

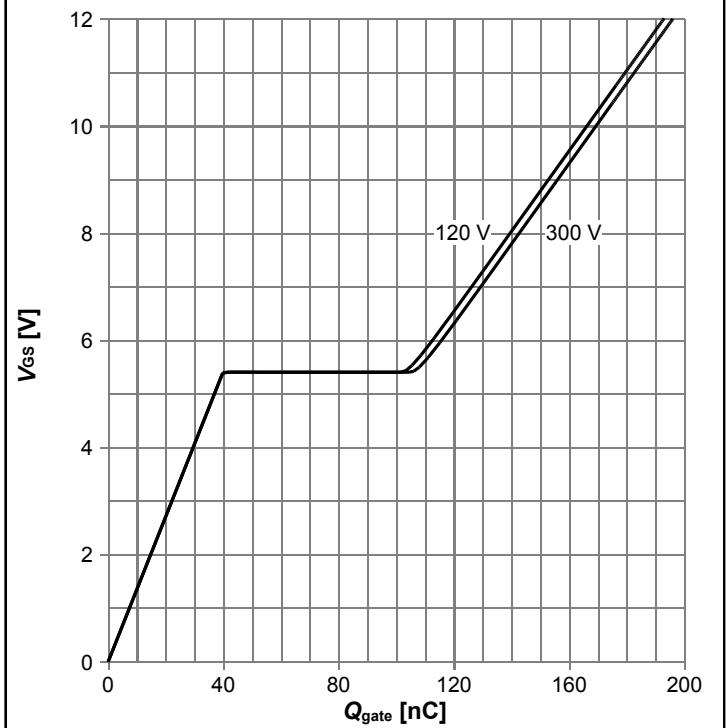

$V_{GS} = f(Q_{gate}); I_D = 29 \text{ A pulsed}; \text{parameter: } V_{DD}$

Diagram 11: Forward characteristics of reverse diode

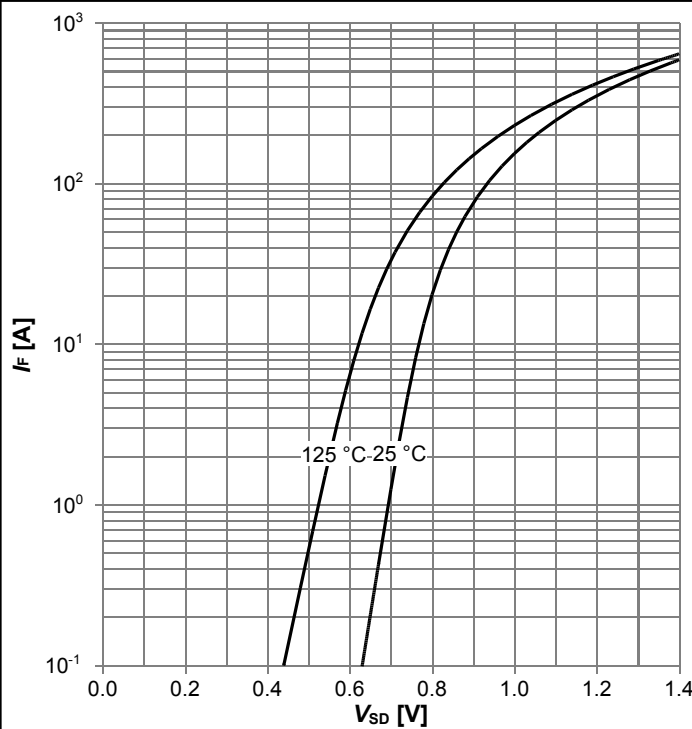

$I_F = f(V_{SD}); V_{GS} = 0 \text{ V}; \text{parameter: } T_j$

Diagram 12: Forward characteristics of reverse diode

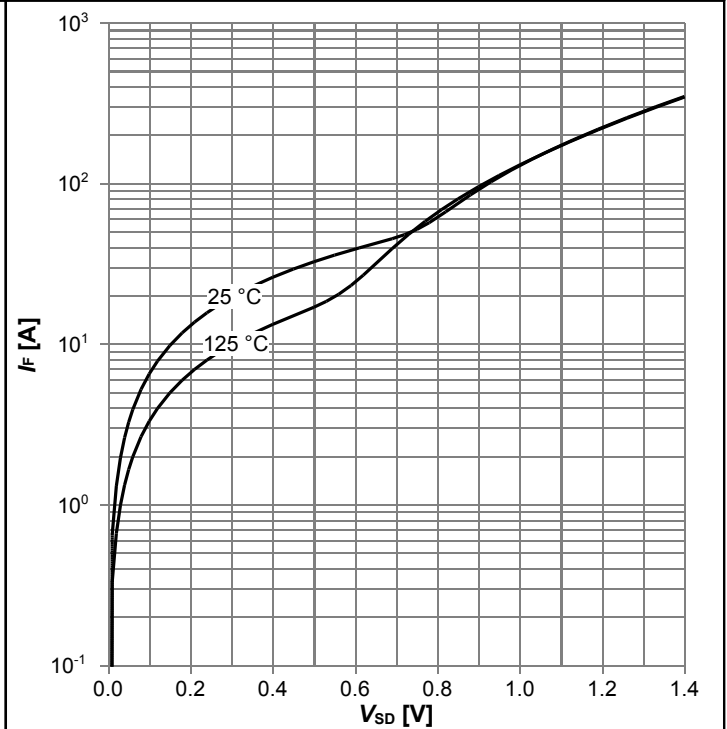

$I_F = f(V_{SD}); V_{GS} = 12 \text{ V}; \text{parameter: } T_j$

Diagram 13: Avalanche energy

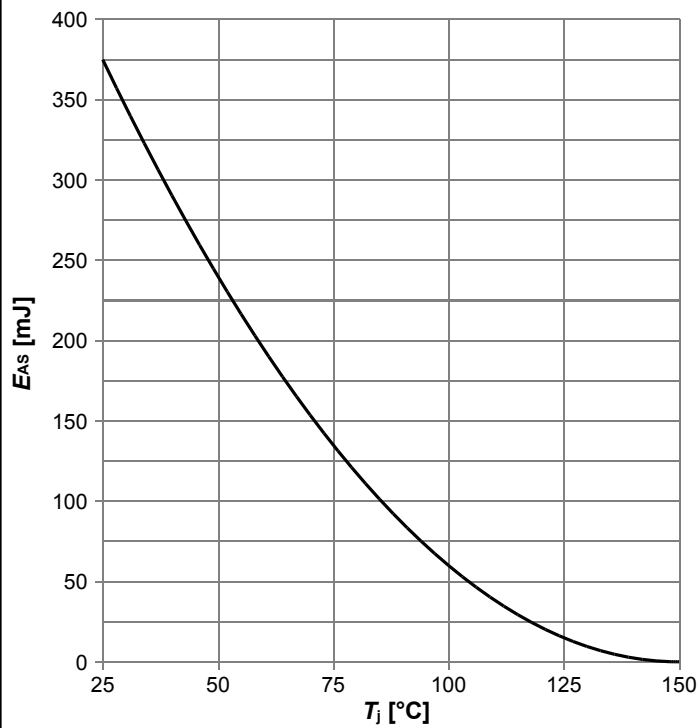

$E_{AS}=f(T_j); I_D=4.4 \text{ A}; V_{DD}=50 \text{ V}$

Diagram 14: Drain-source breakdown voltage

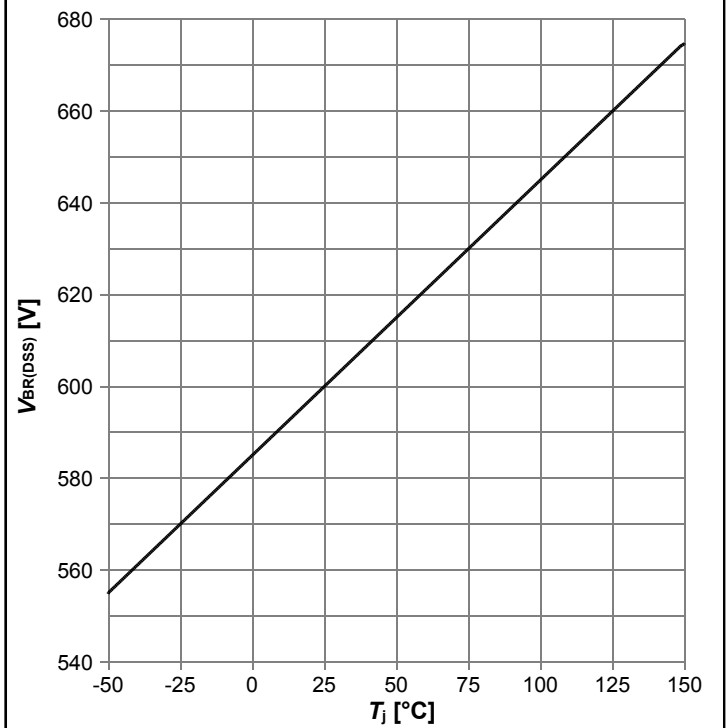

$V_{BR(DSS)}=f(T_j); I_D=1 \text{ mA}$

Diagram 15: Typ. capacitances

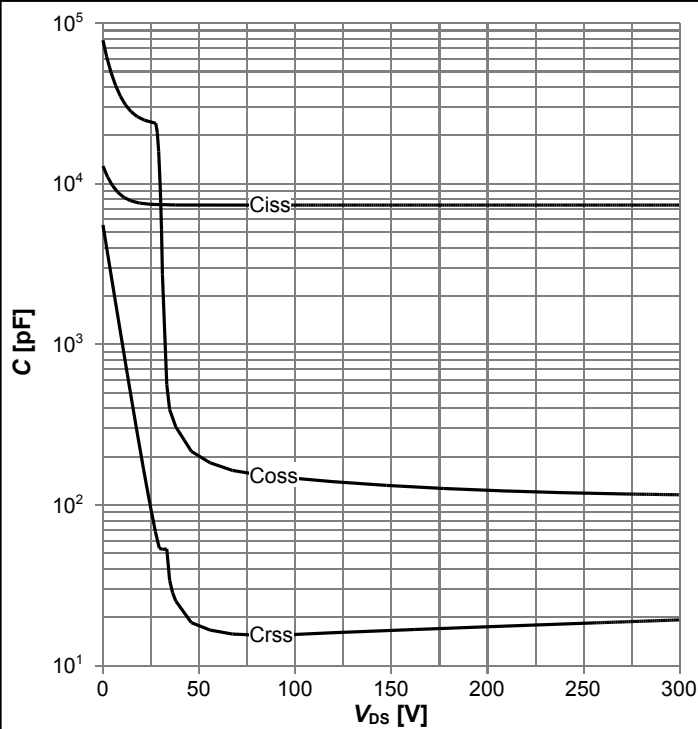

$C=f(V_{DS}); V_{GS}=0 \text{ V}; f=250 \text{ kHz}$

Diagram 17: Typ. Qoss output charge

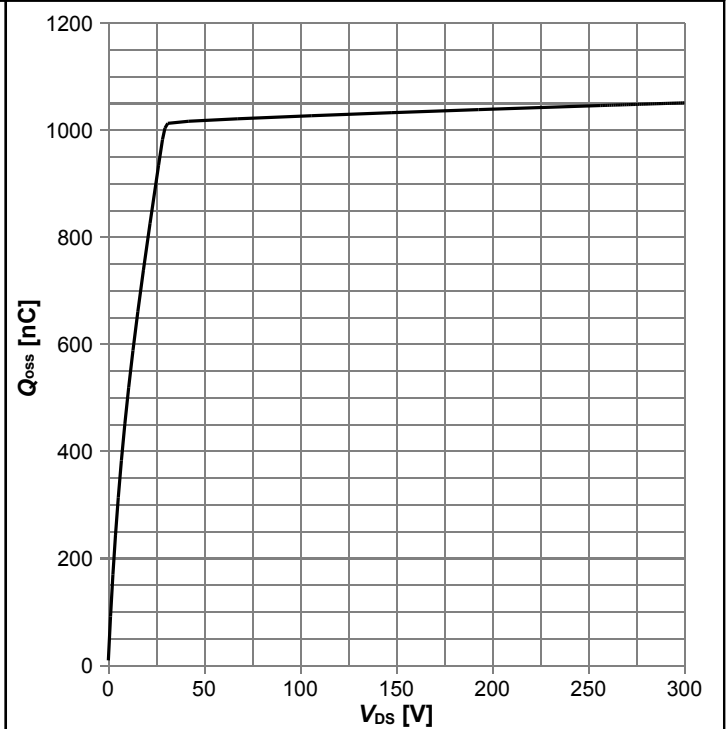

$Q_{oss}=f(V_{DS}); V_{GS}=0 \text{ V}$

6 Test Circuits

Table 10 Diode characteristics

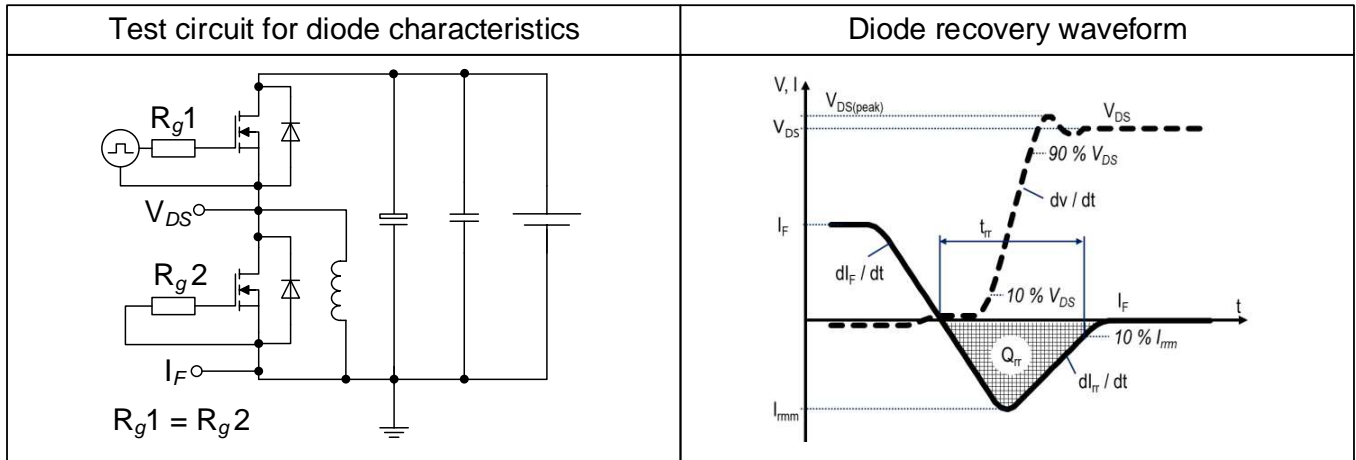

Table 11 Switching times (ss)

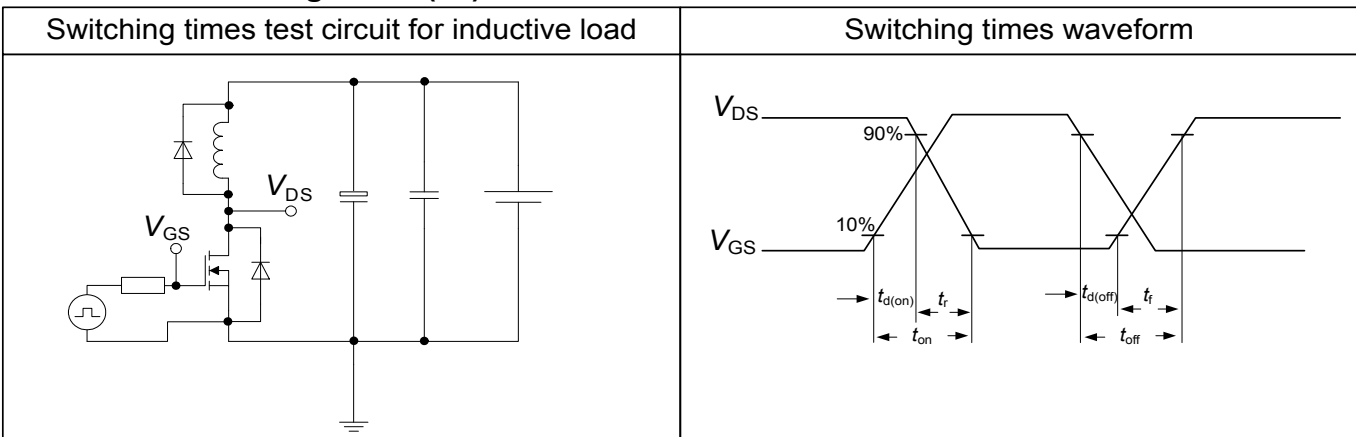
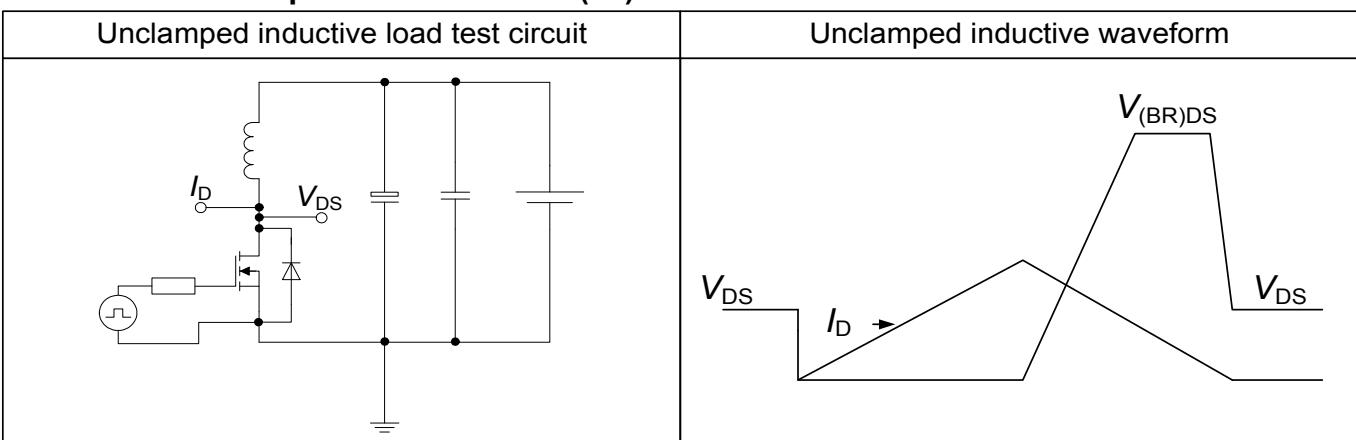

Table 12 Unclamped inductive load (ss)



7 Package Outlines

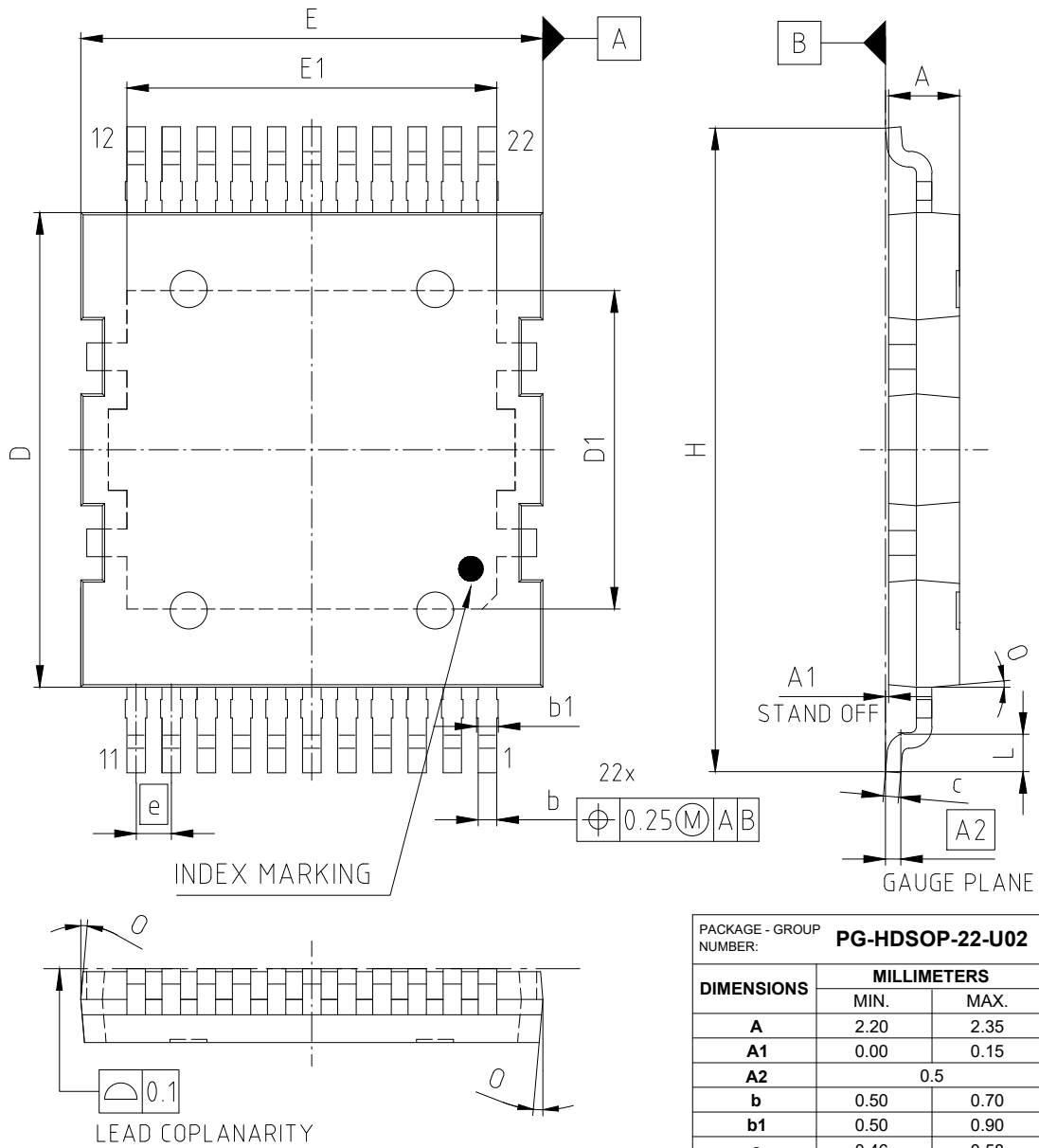

Figure 1 Outline PG-HDSOP-22, dimensions in mm

8 Appendix A

Table 13 Related Links

- IFX CoolMOS S7T Webpage: www.infineon.com
- IFX CoolMOS S7T application note: www.infineon.com
- IFX CoolMOS S7T simulation model: www.infineon.com
- IFX Design tools: www.infineon.com

Revision History

IPQC60T017S7

Revision: 2023-12-11, Rev. 2.0

Previous Revision

Revision	Date	Subjects (major changes since last revision)
2.0	2023-12-11	Release of final version

Trademarks

All referenced product or service names and trademarks are the property of their respective owners.

We Listen to Your Comments

Any information within this document that you feel is wrong, unclear or missing at all? Your feedback will help us to continuously improve the quality of this document. Please send your proposal (including a reference to this document) to:

erratum@infineon.com

Published by

Infineon Technologies AG
81726 München, Germany
© 2023 Infineon Technologies AG
All Rights Reserved.

Legal Disclaimer

The information given in this document shall in no event be regarded as a guarantee of conditions or characteristics ("Beschaffheitsgarantie").

With respect to any examples, hints or any typical values stated herein and/or any information regarding the application of the product, Infineon Technologies hereby disclaims any and all warranties and liabilities of any kind, including without limitation warranties of non-infringement of intellectual property rights of any third party.

In addition, any information given in this document is subject to customer's compliance with its obligations stated in this document and any applicable legal requirements, norms and standards concerning customer's products and any use of the product of Infineon Technologies in customer's applications.

The data contained in this document is exclusively intended for technically trained staff. It is the responsibility of customer's technical departments to evaluate the suitability of the product for the intended application and the completeness of the product information given in this document with respect to such application.

Information

For further information on technology, delivery terms and conditions and prices please contact your nearest Infineon Technologies Office (www.infineon.com).

Warnings

Due to technical requirements, components may contain dangerous substances. For information on the types in question, please contact the nearest Infineon Technologies Office.

The Infineon Technologies component described in this Data Sheet may be used in life-support devices or systems and/or automotive, aviation and aerospace applications or systems only with the express written approval of Infineon Technologies, if a failure of such components can reasonably be expected to cause the failure of that life-support, automotive, aviation and aerospace device or system or to affect the safety or effectiveness of that device or system. Life support devices or systems are intended to be implanted in the human body or to support and/or maintain and sustain and/or protect human life. If they fail, it is reasonable to assume that the health of the user or other persons may be endangered.