

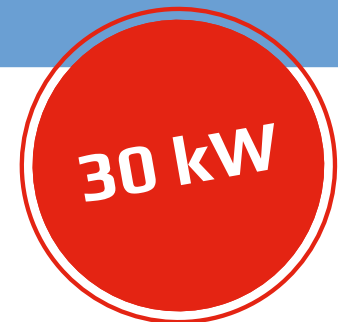

Elektro-Automatik

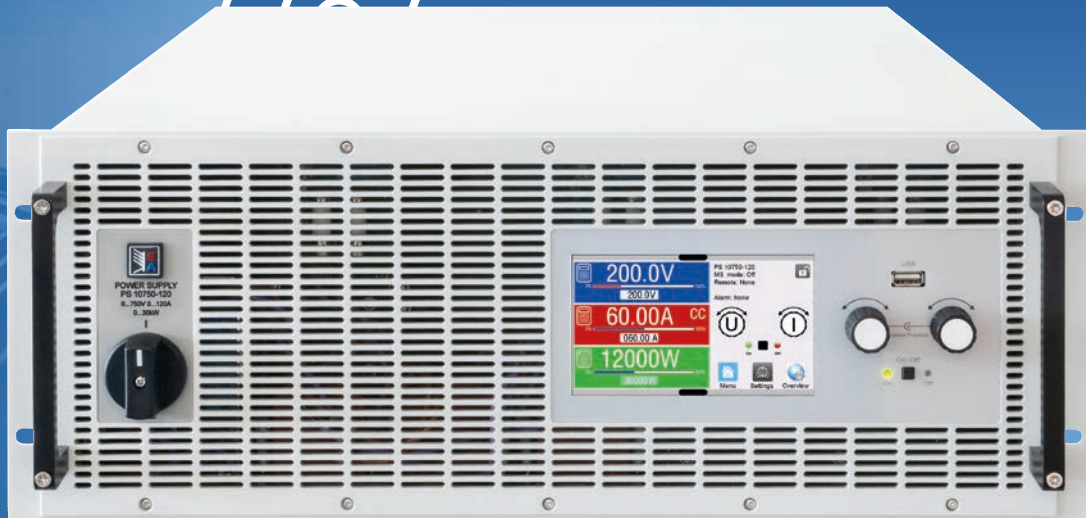

MANUAL

EA-PS 10000 4U

Programmable DC Power Supplies

TABLE OF CONTENTS

1. General

1.1	About this document	4
1.1.1	Retention and use	4
1.1.2	Copyright	4
1.1.3	Validity	4
1.1.4	Symbols and warnings	4
1.2	Warranty	4
1.3	Limitation of liability	4
1.4	Disposal of equipment	5
1.5	Product key	5
1.6	Intended usage	6
1.6.1	Symbols and warnings on the device	6
1.7	Safety	7
1.7.1	Safety notices	7
1.7.2	Responsibility of the operator	8
1.7.3	Requirements to the user	8
1.7.4	Responsibility of the user	8
1.7.5	Alarm signals	9
1.7.6	Functionality test	9
1.8	Technical data	10
1.8.1	Approved operating conditions	10
1.8.2	General technical data	10
1.8.3	Specific technical data	11
1.8.4	Views	15
1.8.5	Control elements	20
1.9	Construction and function	21
1.9.1	General description	21
1.9.2	Block diagram	21
1.9.3	Scope of delivery	22
1.9.4	Accessories	22
1.9.5	Options	22
1.9.6	The control panel (HMI)	23
1.9.7	USB port (rear side)	25
1.9.8	Interface module slot	26
1.9.9	Analog interface	26
1.9.10	"Share BUS" connector	26
1.9.11	"Sense" connector (remote sensing)	27
1.9.12	Master-Slave bus	27
1.9.13	Ethernet port	27
1.9.14	Water cooling	28

2. Installation & commissioning

2.1	Transport and storage	29
2.1.1	Transport	29
2.1.2	Packaging	29
2.1.3	Storage	29
2.2	Unpacking and visual check	29
2.3	Installation	29
2.3.1	Safety procedures before installation and use	29

2.3.2	Preparation	29
2.3.3	Installing the device	30
2.3.4	Installing the water cooling	31
2.3.5	Connection to AC supply	33
2.3.6	Connection to DC loads	35
2.3.7	Grounding of the DC output	36
2.3.8	Connection of remote sense	37
2.3.9	Installation of an interface module	38
2.3.10	Connecting the analog interface	39
2.3.11	Connecting the Share bus	39
2.3.12	Connecting the USB port (rear side)	39
2.3.13	Initial commission	39
2.3.14	Commission after a firmware update or a long period of non-use	39

3. Operation and application

3.1	Personal safety	40
3.2	Operating modes	40
3.2.1	Voltage regulation / Constant voltage	40
3.2.2	Current regulation / constant current / current limiting	41
3.2.3	Power regulation / constant power / power limiting	41
3.2.4	Internal resistance regulation	41
3.3	Alarm conditions	42
3.3.1	Power Fail	42
3.3.2	Overtemperature	42
3.3.3	Overvoltage protection	42
3.3.4	Overcurrent protection	42
3.3.5	Overpower protection	42
3.3.6	Safety OVP	43
3.3.7	Share bus fail	43
3.4	Manual operation	44
3.4.1	Switching on the device	44
3.4.2	Switching the device off	44
3.4.3	Configuration via the menu	44
3.4.4	Adjustment limits	52
3.4.5	Changing the operating mode	52
3.4.6	Manual adjustment of set values	53
3.4.7	Switching the DC output on or off	54
3.4.8	Recording to USB stick (logging)	54
3.4.9	The quick menu	55
3.4.10	The graph	56
3.5	Remote control	57
3.5.1	General	57
3.5.2	Control locations	57
3.5.3	Remote control via a digital interface	57
3.5.4	Remote control via the analog interface	59

3.6	Device alarm handling	63
3.7	Locking the control panel (HMI)	65
3.8	Locking the adjustment limits and user profiles	65
3.9	Loading and saving user profiles	66
3.10	Other applications	67
3.10.1	Parallel operation in master-slave (MS)	67
3.10.2	Series connection	71
3.10.3	SEMI F47	71
4.	Service and maintenance	
4.1	Maintenance / cleaning	72
4.1.1	Battery replacement	72
4.2	Fault finding / diagnosis / repair	72
4.2.1	Firmware updates	72
4.2.2	Trouble-shooting device problems	73
5.	Contact and support	
5.1	General	74
5.2	Contact options	74

Attention! The part of this document that deals with the handling of features on the control panel is only valid for devices with firmwares "KE: 3.02", "HMI: 3.02" and "DR: 1.0.2.20" or higher.

1. General

1.1 About this document

1.1.1 Retention and use

This document is to be kept in the vicinity of the equipment for future reference and explanation of the operation of the device. This document is to be delivered and kept with the equipment in case of change of location and/or user.

The most recent issue of this document can be found online, on our website.

1.1.2 Copyright

Reprinting, copying, also partially, usage for other purposes as foreseen of this manual are forbidden and breach may lead to legal process.





1.1.3 Validity

This manual is valid for the following equipment including derived variants:

Model	Model	Model
EA-PS 10060-1000 4U	EA-PS 10500-180 4U	EA-PS 11500-60 4U
EA-PS 10080-1000 4U	EA-PS 10750-120 4U	EA-PS 12000-40 4U
EA-PS 10200-420 4U	EA-PS 10920-125 4U	
EA-PS 10360-240 4U	EA-PS 11000-80 4U	

1.1.4 Symbols and warnings

Warning and safety notices as well as general notices in this document are shown in a box with a symbol as follows:

	Symbol for a life threatening danger (electric shock hazard)
	Symbol for risk (of damage to the equipment). If placed on the device it requests the user to read the operating guide prior to start operation.
	Symbol for general safety notices (instructions and damage protection bans) or important information for operation
	<i>Symbol for general notices</i>

1.2 Warranty

EA Elektro-Automatik guarantees the functional competence of the applied technology and the stated performance parameters. The warranty period begins with the delivery of free from defects equipment.

Terms of guarantee are included in the general terms and conditions (TOS) of EA Elektro-Automatik.

1.3 Limitation of liability

All statements and instructions in this manual are based on current norms and regulations, up-to-date technology and our long term knowledge and experience. The manufacturer accepts no liability for losses due to:

- Usage for purposes other than designed
- Use by untrained personnel
- Rebuilding by the customer
- Technical changes
- Use of not authorized spare parts

The actual delivered device(s) may differ from the explanations and diagrams given here due to latest technical changes or due to customized models with the inclusion of additionally ordered options.

1.4 Disposal of equipment

A piece of equipment which is intended for disposal must, according to European laws and regulations (ElektroG, WEEE) be returned to the manufacturer for scrapping, unless the person operating the piece of equipment or another, delegated person is conducting the disposal. Our equipment falls under these regulations and is accordingly marked with the following symbol:



The device contains a Lithium battery cell. Disposal of that battery follows the above stated rule or specific local regulations.

1.5 Product key

Decoding of the product description on the label, using an example:

EA-PS 10 080 - 1000 4U zzz

	Field for identification of installed options: WC = Water cooling installed
	Construction (only stated on type label): 4U = 19" frame with 4U
	Maximum current of the device in Ampere
	Maximum voltage of the device in Volt („10080“ = 80 Volt)
	Series: 10 = Series 10000
	Type identification: PS = Power Supply

1.6 Intended usage





The equipment is intended to be used only as a variable voltage and current source or only as a variable current sink. Furthermore it's only intended to be used installed and operated in suitable equipment (19" rack or similar), together with a rigid, non-retractable AC supply connection.

Typical application for a voltage source is DC power supply to any relevant user, including when used as battery charger to test charge various battery types, and for current sinks the replacement of an ohmic resistor by an adjustable electronic DC load in order to load relevant voltage and current sources of any type.



- Claims of any sort due to damage caused by non-intended usage will not be accepted.
- All damage caused by non-intended usage is solely the responsibility of the operator.

1.6.1 Symbols and warnings on the device

Decal	Explanation
 <div data-bbox="276 629 539 819"> <p>⚠ DANGER RISK OF ELECTRIC SHOCK Disconnect all sources of supply prior to servicing.</p> </div>	<p>This warning is primarily related to the reconfiguration of the device on the DC terminal which, for safety reasons, requires to also cut the device from AC (external main switch). The same applies to disconnection and reconnection of the AC terminal.</p>
 <div data-bbox="276 860 539 1050"> <p>⚠ DANGER Capacitors on DC, storing voltage! Discharge for 10 sec then ground before working.</p> </div>	<p>Even after disconnection of the DC terminal from an external source there can still be dangerous voltage potential present between the DC terminal poles and/or between DC and the enclosure. For safety reasons the DC terminal must be short-circuited after the capacitors have been discharged and it must also be grounded, i. e. connected to PE.</p>
 <div data-bbox="276 1095 539 1285"> <p>⚠ WARNING ELECTRICAL HAZARDS Authorized personnel only.</p> </div>	<p>There can always be a voltage potential on metallic, openly touchable parts on electrical devices, though the voltage level may not be hazardous. Caution is still advisable, as these potential can still cause mild electrical shocks or sparking.</p>
 <div data-bbox="276 1330 539 1520"> <p>⚠ WARNING Read and understand the operating guide before using this device. Non-adherence of the instructions in the operating guide can result in serious injury or death.</p> </div>	<p>This is valid for any use of the device.</p>

Mortal danger - Hazardous voltage



- **Electrical equipment operation means that some parts accessible on the outside of the device can be under high voltage. Therefore all parts under voltage must be covered during operation! This basically applies to all models, except for the 60 V model according to SELV.**
- **The DC terminal is isolated from the AC input and not connected to ground internally. Hence there can be dangerous potential between the DC poles and PE, for instance caused by a connected external source application. Due to charged capacitors this could even be true if the DC output or the device are already switched off.**
- **Do not insert any object, particularly metallic, through the ventilator slots!**
- **For every reconfiguration on the AC or DC terminals, specifically those which can have a dangerous voltage potential, the device must be cut completely from the AC supply (main switch on the distant end of the AC cable); it doesn't suffice to only use the power switch on the front**
- **Always follow 5 safety rules when working with electric devices:**
 - **Disconnect completely**
 - **Secure against reconnection**
 - **Verify that the system is dead**
 - **Carry out earthing and short-circuiting**
 - **Provide protection from adjacent live parts**



- Avoid any use of liquids near the equipment. Protect the device from wet, damp and condensation.
- Do not connect external power sources with reversed polarity to the DC terminal! The equipment will be damaged, even when completely powered off.
- Never connect external power sources to the DC terminal that can generate a higher voltage than the rated voltage of the device!
- Never insert a network cable which is connected to Ethernet or its components into the master-slave sockets on the rear side of the device!



- The equipment must only be used as intended
- The equipment is only approved for use within the connection limits stated on the product label.
- ESD regulations must be applied when plugging interface cards or modules into the relative slot
- Interface cards or modules may only be attached or removed after the device is switched off. It's not necessary to open the device.
- Always configure the various protecting features against overcurrent, overvoltage etc. for sensitive loads to what the target application requires!
- It's not allowed to run the device on AC sources such as generators or UPS equipment. It must only be connected to a power grid!
- When controlling the device manually on the HMI while it's connected to any controlling unit (PLC, PC etc.) via any analog or digital interface, that controlling unit could take over remote control anytime; for safety reasons it's recommended to block remote control by activating the so-called local mode (also see "3.4. Manual operation" and "3.4.3. Configuration via the menu")

1.7.2 Responsibility of the operator

Operator is any natural or legal person who uses the equipment or delegates the usage to a third party, and is responsible during its usage for the safety of the user, other personnel or third parties.

The equipment is in industrial operation. Therefore the operators are governed by the legal safety regulations. Alongside the warning and safety notices in this manual the relevant safety, accident prevention and environmental regulations must also be applied. In particular the operator has to

- be acquainted with the relevant job safety requirements
- identify other possible dangers arising from the specific usage conditions at the work station via a risk assessment
- introduce the necessary steps in the operating procedures for the local conditions
- regularly control that the operating procedures are current
- update the operating procedures where necessary to reflect changes in regulation, standards or operating conditions.
- define clearly and unambiguously the responsibilities for operation, maintenance and cleaning of the equipment.
- ensure that all employees who use the equipment have read and understood the manual. Furthermore the users are to be regularly schooled in working with the equipment and the possible dangers.
- provide all personnel who work with the equipment with the designated and recommended safety equipment

Furthermore, the operator is responsible for ensuring that the device is at all times technically fit for use.

1.7.3 Requirements to the user

Any activity with equipment of this type may only be performed by persons who are able to work correctly and reliably and satisfy the requirements of the job.

- Persons whose reaction capability is negatively influenced by e.g. drugs, alcohol or medication may not operate the equipment.
- Age or job related regulations valid at the operating site must always be applied.



Danger for unqualified users

Improper operation can cause person or object damage. Only persons who have the necessary training, knowledge and experience may use the equipment.

The group of people allowed to operate the equipment is additionally limited to:

Delegated persons: these are persons who have been properly and demonstrably instructed in their tasks and the attendant dangers.

Qualified persons: these are persons who are able through training, knowledge and experience as well as knowledge of the specific details to carry out all the required tasks, identify dangers and avoid personal and other risks.

1.7.4 Responsibility of the user

The equipment is in industrial operation. Therefore the operators are governed by the legal safety regulations. Alongside the warning and safety notices in this manual the relevant safety, accident prevention and environmental regulations must also be applied. In particular the users of the equipment:

- must be informed of the relevant job safety requirements
- must work to the defined responsibilities for operation, maintenance and cleaning of the equipment
- before starting work must have read and understood the operating manual
- must use the designated and recommended safety equipment.

Furthermore, anyone working with the equipment is responsible for ensuring that the device is at all times technically fit for use.

1.7.5 Alarm signals

The equipment offers various possibilities for signaling alarm conditions, however, not for danger situations. The signals may be optical (on the display as text), acoustic (piezo buzzer) or electronic (status output of the analog interface or digitally readable status bits). All alarms will cause the device to switch off the DC output. For details about the different alarms refer to section "3.3. Alarm conditions".

The meaning of the signals is as follows:

Signal OT (OverTemperature)	<ul style="list-style-type: none"> • Overheating of the device • DC output will be switched off • Non-critical
Signal OVP / SOVP (OverVoltage)	<ul style="list-style-type: none"> • Overvoltage shutdown of the DC output due to excess of the preset limit • Critical! The device and/or the load could be damaged
Signal OC (OverCurrent)	<ul style="list-style-type: none"> • Shutdown of the DC output due to excess of the preset limit • Non-critical, protects the load from excessive current consumption
Signal OPP (OverPower)	<ul style="list-style-type: none"> • Shutdown of the DC output due to excess of the preset limit • Non-critical, protects the load from excessive power consumption
Signal PF (Power Fail)	<ul style="list-style-type: none"> • DC output shutdown due to AC undervoltage or defect in the AC input • Critical on overvoltage! AC input circuit could be damaged
Signal MSP (Master-Slave Protection)	<ul style="list-style-type: none"> • DC output shutdown due to communication problems on the master-slave bus • Non-critical
Signal SF (Share Bus Fail)	<ul style="list-style-type: none"> • DC output shutdown due to signal distortion on the Share bus • Non-critical

1.7.6 Functionality test

The operator of the device must decide when to check the device for correct functionality, by whom and how often. The when could either be before every use or after it has been relocated or reconfigured or perhaps in a defined interval.



Should the set values not be adjustable as instructed below it could simply be due to adjustment limits interfering. See "3.4.4. Adjustment limits". When reaching a limit when adjusting value, the device would indicate in the display.

The test procedure would always be like this:

1. Disconnect all cables (DC, Sense, Share bus, analog interface, USB), except for AC
2. Connect a suitable voltage meter to the DC terminal
3. Switch the device on, adjust a voltage of 10% UNom while the current and power set values all should be at maximum, switch the DC output on and measure the voltage with the multimeter and compare. Also check what the actual voltage on the display shows.
4. Repeat the same thing at 100% UNom.
5. Switch the DC output off and bridge the DC terminal with a cable or copper rails of suitable current capability of at least INom. If available, put a current measuring device (transducer, current probe).
6. Adjust the current for source mode to 10% INom, switch the DC output on and measure the current with the external measuring device, if available and compare the measured current to the actual and set value of current on the display or at least compare the actual current on display with the set value.
7. Repeat the same thing at 100% INom.

Only if the current and voltage are supplied by the device as adjustable in the range of 0-100% FS, the device can be considered as correctly operational.

1.8 Technical data

1.8.1 Approved operating conditions

1.8.1.1 Ambiance

The allowed ambient temperature range for operation is 0 °C (32 °F) to 50 °C (122 °F). During storage or transport, the allowed range extends to -20 °C (-4 °F) to 70 °C (158 °F). In case water condensation occurred due to transport, the device must be acclimatized prior to operation for at least 2 hours, ideally in a place with good air circulation.

The device is intended to be operation in dry rooms. It must not be exposed or operated to extreme dust, high air humidity, danger of explosion and aggressive chemicals polluting the air. The operating position isn't arbitrary (see "2.3.3. *Installing the device*"),but in any case it requires a sufficient air circulation. The device is allowed to be operated in altitude up to 2000 m (approx. 6,560 ft) above sea level. Technical specifications (here: ratings), when given with tolerance, are valid for a unit warmed up for at least 30 minutes and for an ambient temperature of 23 °C (73 °F). Specifications without tolerance are typical values from an average device.

1.8.1.2 Cooling

Power dissipated inside the device heats up air circulating through the device. A fan at the end of an air flow channel,in which a cooling block is placed, pulls the air through the device. Entry is on the front, exhaust at the back. Depending on the internal temperature, the fan speed is automatically regulated up or down, whereas a certain minimum speed is maintained because some internal components even heat up when the device is idle.

Dust in the air can obstruct the air flow with time, thus it's important to keep the air flow unimpeded at least outside of the device be leaving sufficient room behind it. Since it's usually installed inside cabinets, the cabinet doors are required to be meshed.

At the same time, the ambient temperature should be kept at low levels, perhaps by external means such as an air condition. Should the device heat up internally and the cooling block temperature exceed 80 °C (160 °F), the device will protect itself from overheating by automatically switching off the power stage. It could then only continue to operate and switch the power stage on again after cooling down for some time.

For the water-cooled versions, water is the main cooling agent, flowing through the internal cooling blocks. The air inside the almost hermetically body circulates, engaged by fans, to cool the remaining components not sitting on the cooling blocks, but heat up over time.

1.8.2 General technical data

Display: Color TFT touch screen with gorilla glass, 5", 800pt x 480pt, capacitive
Controls: 2 rotary knobs with pushbutton function, 1 pushbutton

1.8.3 Specific technical data

General specifications	
AC input	
Voltage, Phases	Range 1: 208 V, $\pm 10\%$, 3ph AC (with DC output power derating to 18 kW) Range 2: 380 - 480 V, $\pm 10\%$, 3ph AC
Frequency	45 - 65 Hz
Power factor	ca. 0.99
Leakage current	<10 mA
Inrush current / Phase current	≤ 56 A
Overvoltage category	2
DC output static	
Load regulation CV	$\leq 0.05\%$ FS (0 - 100% load, constant input voltage and constant temperature)
Line regulation CV	$\leq 0.01\%$ FS (208 V - 480 V AC $\pm 10\%$ supply voltage, constant load and constant temperature)
Stability CV	$\leq 0.02\%$ FS (during 8 h of operation, after 30 minutes warm-up, at constant output voltage, load and temperature)
Temperature coefficient CV	≤ 30 ppm/ $^{\circ}$ C (after 30 minutes of warm-up)
Compensation (Remote Sense)	$\leq 5\%$ U_{Nominal}
Load regulation CC	$\leq 0.1\%$ FS (0 - 100% load, constant output voltage and constant temperature)
Line regulation CC	$\leq 0.01\%$ FS (208 V - 480 V AC $\pm 10\%$ supply voltage, constant load and constant temperature)
Stability CC	$\leq 0.02\%$ FS (during 8 h of operation, after 30 minutes warm-up, at constant output voltage, load and temperature)
Temperature coefficient CC	≤ 50 ppm/ $^{\circ}$ C (after 30 minutes of warm-up)
Load regulation CP	$\leq 0.3\%$ FS (0 - 100% load, constant output voltage and constant temperature)
Load regulation CR	$\leq 0.3\%$ FS + 0.1% FS current (0 - 100% load, constant output voltage and constant temperature)
Protective functions	
OVP	Overvoltage protection, adjustable 0 - 110% U_{Nominal}
OCP	Overcurrent protection, adjustable 0 - 110% I_{Nominal}
OPP	Overpower protection, adjustable 0 - 110% P_{Nominal}
OT	Overtemperature protection (DC output shuts down in case of insufficient cooling)
DC output dynamic	
Rise time 10 - 90% CV	≤ 10 ms
Fall time 90 - 10% CV	≤ 10 ms
Rise time 10 - 90% CC	≤ 2 ms
Fall time 90 - 10% CC	≤ 2 ms
Display accuracy	
Voltage	$\leq 0.05\%$ FS
Current	$\leq 0.1\%$ FS
Insulation	
AC input to DC output	3750 Vrms (1 minute, creepage distance >8 mm) *1
AC input to case (PE)	2500 Vrms
DC output to case (PE)	Depending on the model, see model tables
DC output to interfaces	1000 V DC (models up to 360 V rating), 1500 V DC (models from 500 V rating)
Interfaces digital	
Built-in, galvanically isolated	USB, Ethernet (100 MBit) for communication, 1x USB Host for data acquisition
Optional, galvanically isolated	CAN, CANopen, RS232, ModBus TCP, Profinet, Profibus, EtherCAT, Ethernet
Interfaces analog	
Built-in, galvanically isolated	15 pole D-Sub
Signal range	0 - 10 V or 0 - 5 V (switchable)
Inputs	U, I, P, R, remote control on/off, DC output on/off, resistance mode on/off
Outputs	Monitor U and I, alarms, reference voltage, DC output status, CV/CC regulation mode
Accuracy U / I / P / R	0 - 10 V: $\leq 0.2\%$, 0 - 5 V: $\leq 0.4\%$

*1 Models up to 80 V DC rating have reinforced insulation while all other models from 200 V DC rating have basic insulation

General specifications	
Device configuration	
Parallel operation	Up to 64 units of any power class in series 10000, with master-slave bus and Share bus
Safety and EMC	
Safety	EN 61010-1 IEC 61010-1 UL 61010-1 CSA C22.2 No 61010-1 BS EN 61010-1
EMC	EN 55011, class B CISPR 11, class B FCC 47 CFR part 15B, unintentional radiator, class B EN 61326-1 include tests according to: - EN 61000-4-2 - EN 61000-4-3 - EN 61000-4-4 - EN 61000-4-5 - EN 61000-4-6
Safety protection class	1
Ingress Protection	IP20
Environmental conditions	
Operating temperature	0 - 50 °C (32 - 122 °F)
Storage temperature	-20 - 70 °C (-4 - 158 °F)
Humidity	≤80% relative humidity, non-condensing
Altitude	≤2000 m (≤6,600 ft)
Pollution degree	2
Mechanical construction	
Cooling	Forced air flow from front to rear (temperature controlled fans), optional water cooling
Dimensions (W x H x D)	Enclosure: 19" x 4U x 668 mm (26.3 in) Total: 19" x 4U x min. 785 mm (31 in)
Weight	50 kg (110 lb)
Weight with water cooling	56 kg (126 lb)

Technical specifications	PS 10060-1000	PS 10080-1000	PS 10200-420	PS 10360-240
DC output				
Voltage range	0 - 60 V	0 - 80 V	0 - 200 V	0 - 360 V
Ripple in CV (rms)	≤25 mV (BW 300 kHz)	≤25 mV (BW 300 kHz)	≤40 mV (BW 300 kHz)	≤55 mV (BW 300 kHz)
Ripple in CV (pp)	≤320 mV (BW 20 MHz)	≤320 mV (BW 20 MHz)	≤300 mV (BW 20 MHz)	≤320 mV (BW 20 MHz)
Current range	0 - 1000 A	0 - 1000 A	0 - 420 A	0 - 240 A
Power range	0 - 30000 W	0 - 30000 W	0 - 30000 W	0 - 30000 W
Resistance range	0.003 Ω - 5 Ω	0.003 Ω - 5 Ω	0.0165 Ω - 25 Ω	0.05 Ω - 90 Ω
Output capacitance	25380 μF	25380 μF	5400 μF	1800 μF
Efficiency (up to)	95.1% *1	95.5% *1	95.3% *1	95.8% *1
Insulation				
Negative DC pole <-> PE	±600 V DC	±600 V DC	±1000 V DC	±1000 V DC
Positive DC pole <-> PE	+600 V DC	+600 V DC	+1000 V DC	+1000 V DC
Article numbers				
Standard	06230900	06230901	06230902	06230903
Standard + Water Cooling	06250900	06250901	06250902	06250903

*1 At 100% power and 100% output voltage

Technical specifications	PS 10500-180	PS 10750-120	PS 10920-125	PS 11000-80
DC output				
Voltage range	0 - 500 V	0 - 750 V	0 - 920 V	0 - 1000 V
Ripple in CV (rms)	≤70 mV (BW 300 kHz)	≤200 mV (BW 300 kHz)	≤200 mV (BW 300 kHz)	≤300 mV (BW 300 kHz)
Ripple in CV (pp)	≤350 mV (BW 20 MHz)	≤800 mV (BW 20 MHz)	≤800 mV (BW 20 MHz)	≤1600 mV (BW 20 MHz)
Current range	0 - 180 A	0 - 120 A	0 - 125 A	0 - 80 A
Power range	0 - 30000 W	0 - 30000 W	0 - 30000 W	0 - 30000 W
Resistance range	0.08 Ω - 170 Ω	0.2 Ω - 370 Ω	0.25 Ω - 550 Ω	0.4 Ω - 650 Ω
Output capacitance	675 μF	450 μF	100 μF	200 μF
Efficiency (up to)	96.5% *1	96.5% *1	96.5% *1	95.8% *1
Insulation				
Negative DC pole <-> PE	±1500 V DC	±1500 V DC	±1500 V DC	±1500 V DC
Positive DC pole <-> PE	+2000 V DC	+2000 V DC	+2000 V DC	+2000 V DC
Article numbers				
Standard	06230904	06230905	06230909	06230906
Standard + Water Cooling	06250904	06250905	06250909	06250906

*1 At 100% power and 100% output voltage

Technical specifications	PS 11500-60	PS 12000-40		
DC output				
Voltage range	0 - 1500 V	0 - 2000 V		
Ripple in CV (rms)	≤400 mV (BW 300 kHz)	≤500 mV (BW 300 kHz)		
Ripple in CV (pp)	≤2400 mV (BW 20 MHz)	≤3000 mV (BW 20 MHz)		
Current range	0 - 60 A	0 - 40 A		
Power range	0 - 30000 W	0 - 30000 W		
Resistance range	0.8 Ω - 1500 Ω	1.7 Ω - 2700 Ω		
Output capacitance	75 μF	50 μF		
Efficiency (up to)	96.5% *1	96.5% *1		
Insulation				
Negative DC pole <-> PE	±1500 V DC	±1500 V DC		
Positive DC pole <-> PE	+2000 V DC	+2000 V DC		
Article numbers				
Standard	06230907	06230908		
Standard + Water Cooling	06250907	06250908		

*1 At 100% power and 100% output voltage

1.8.4 Views
 1.8.4.1 Technical Drawing PS 10000 4U ≤200 V

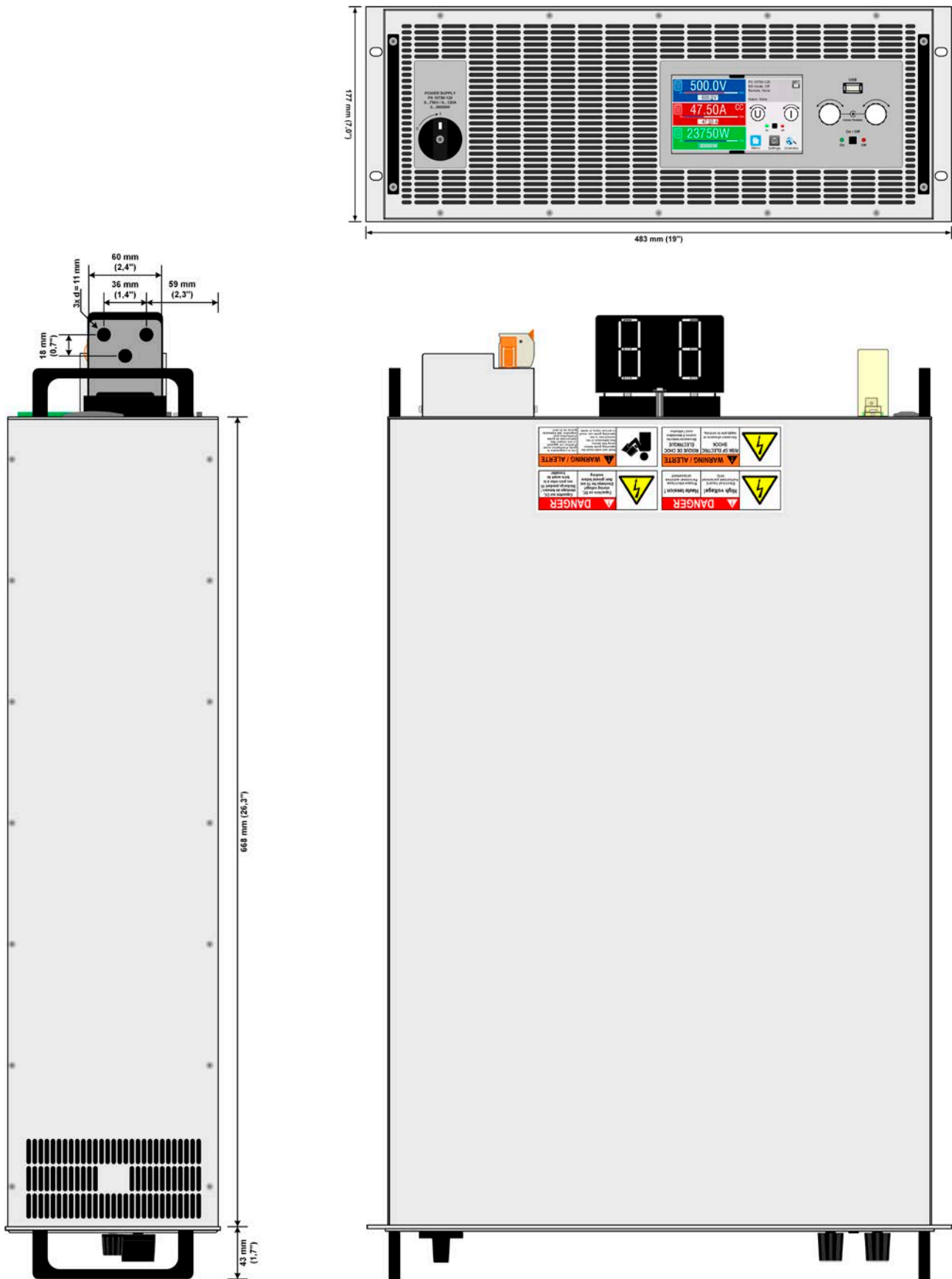

1.8.4.2 Front Panel Description PS 10000 4U

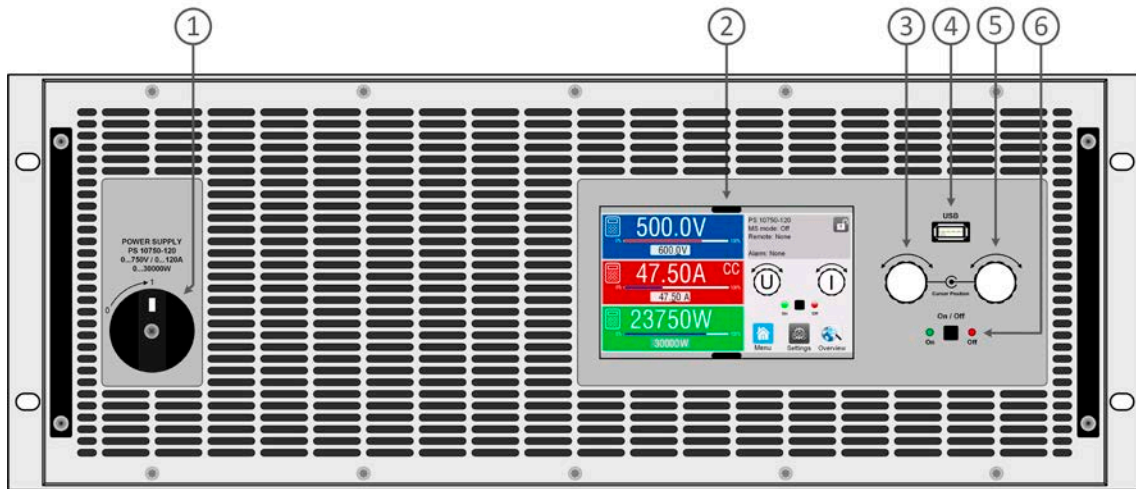

1. Power switch
2. TFT control interface, interactive operation and display
3. Rotary knob with push-button action, for settings and control
4. USB host, uses USB sticks for data logging and sequencing
5. Rotary knob with push-button action, for settings and control
6. On / Off push-button with LED status display

1.8.4.3 Rear Panel Description PS 10000 4U ≤ 200 V

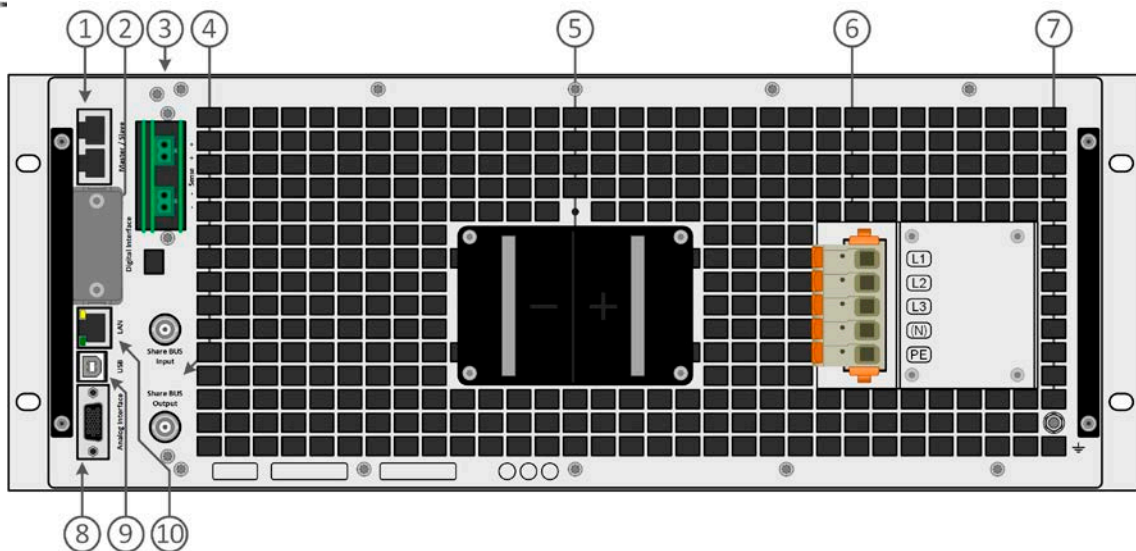

1. Master-Slave bus connectors to set up a system for parallel connection
2. Slot for interfaces
3. Remote sense connectors
4. Share bus connectors to set up a system for parallel connection
5. DC output terminal (copper blades)
6. AC input connector
7. Grounding connection screw (PE)
8. Connector (DB15 female) for isolated analog programming, monitoring and other functions
9. USB interface
10. Ethernet interface

1.8.4.4 Technical Drawing PS 10000 4U ≥ 360 V

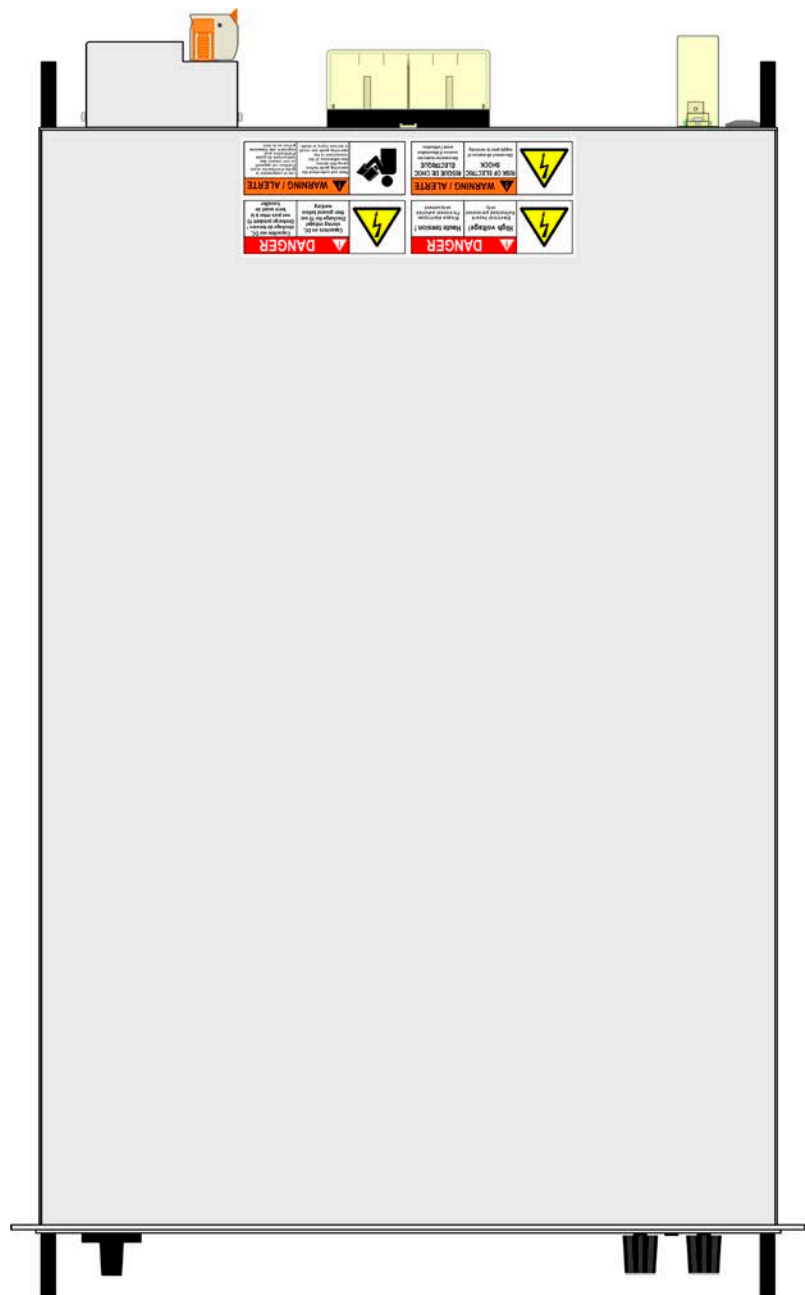
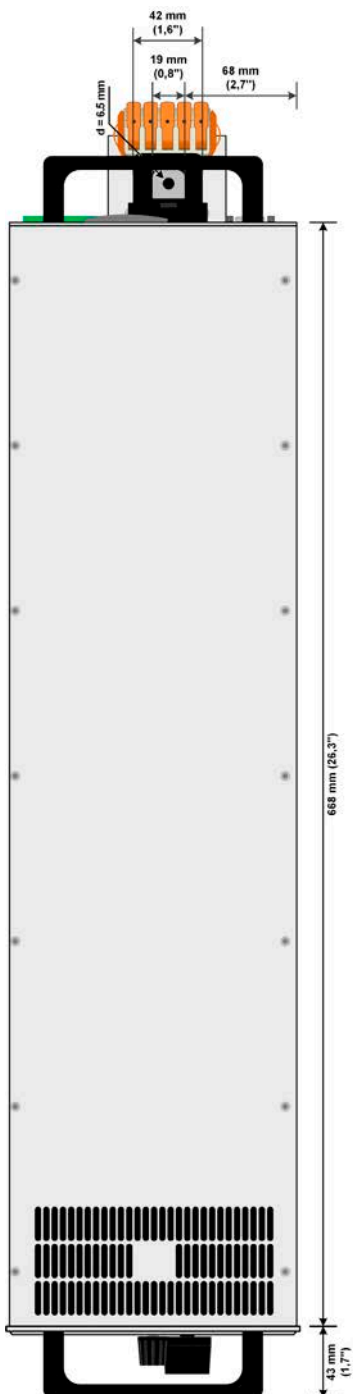
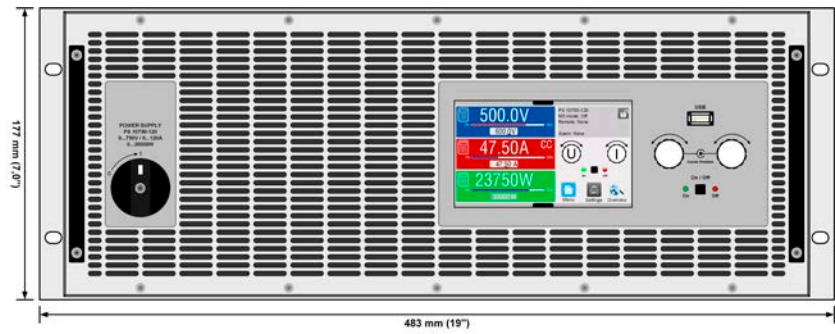

1.8.4.5 Front Panel Description PS 10000 4U

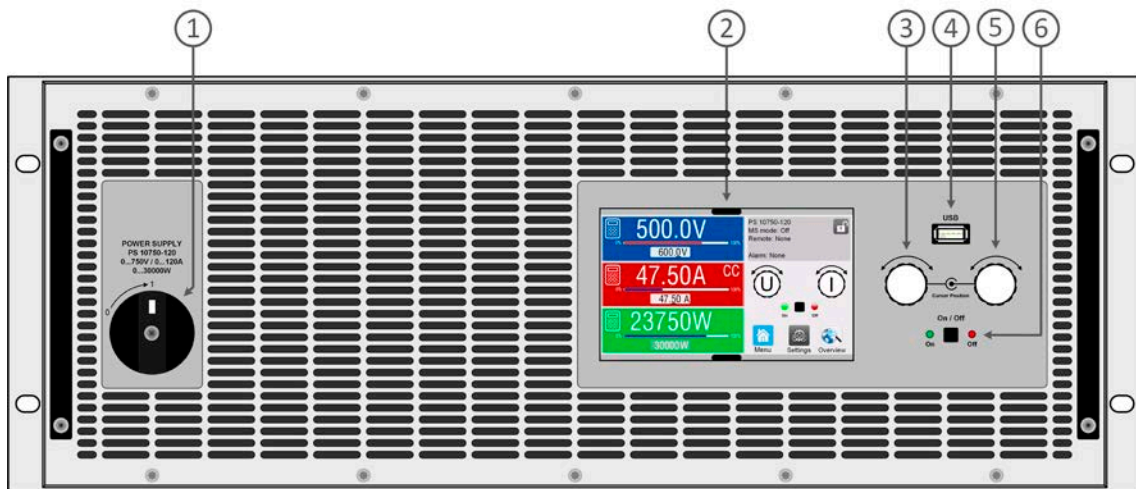

1. Power switch
2. TFT control interface, interactive operation and display
3. Rotary knob with push-button action, for settings and control
4. USB host, uses USB sticks for data logging and sequencing
5. Rotary knob with push-button action, for settings and control
6. On / Off push-button with LED status display

1.8.4.6 Rear Panel Description PS 10000 4U ≥ 360 V

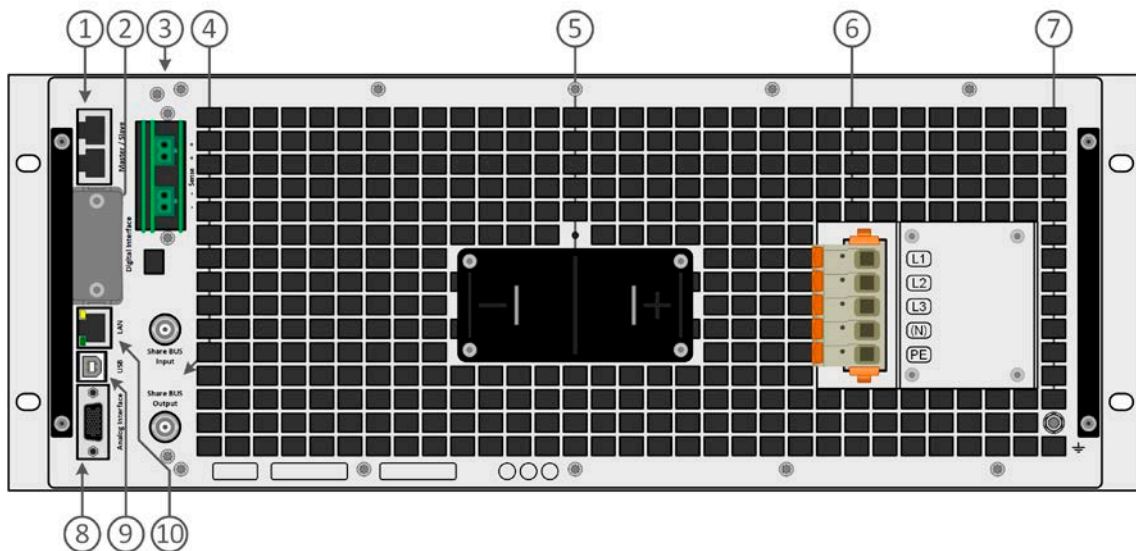

1. Master-Slave bus connectors to set up a system for parallel connection
2. Slot for interfaces
3. Remote sense connectors
4. Share bus connectors to set up a system for parallel connection
5. DC output terminal (copper blades)
6. AC input connector
7. Grounding connection screw (PE)
8. Connector (DB15 female) for isolated analog programming, monitoring and other functions
9. USB interface
10. Ethernet interface

1.8.4.7 Front Panel Description PS 10000 4U Water Cooling Option

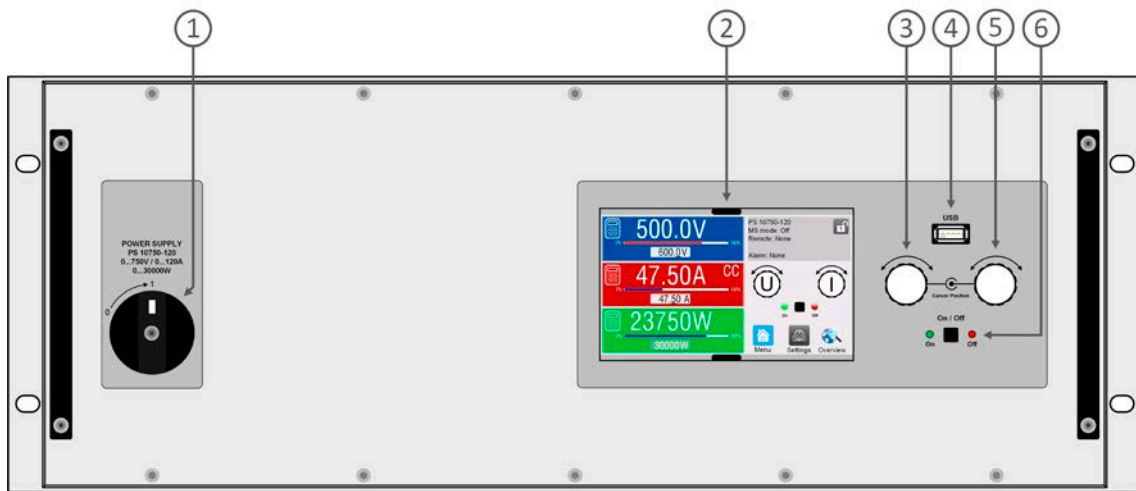

1. Power switch
2. TFT control interface, interactive operation and display
3. Rotary knob with push-button action, for settings and control
4. USB host, uses USB sticks for data logging and sequencing
5. Rotary knob with push-button action, for settings and control
6. On / Off push-button with LED status display

1.8.4.8 Rear Panel Description PS 10000 4U Water Cooling Option

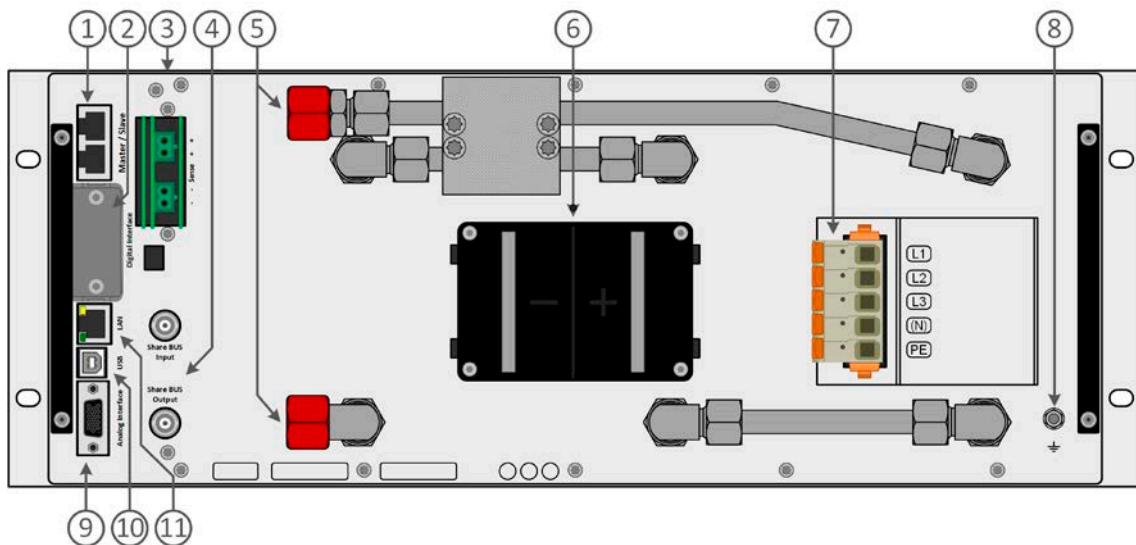

1. Master-Slave bus connectors to set up a system for parallel connection
2. Slot for interfaces
3. Remote sense connectors
4. Share bus connectors to set up a system for parallel connection
5. Inlets and outlets for water-cooling
6. DC output terminal (copper blades)
7. AC input connector
8. Grounding connection screw (PE)
9. Connector (DB15 female) for isolated analog programming, monitoring and other functions
10. USB interface
11. Ethernet interface

1.8.5 Control elements

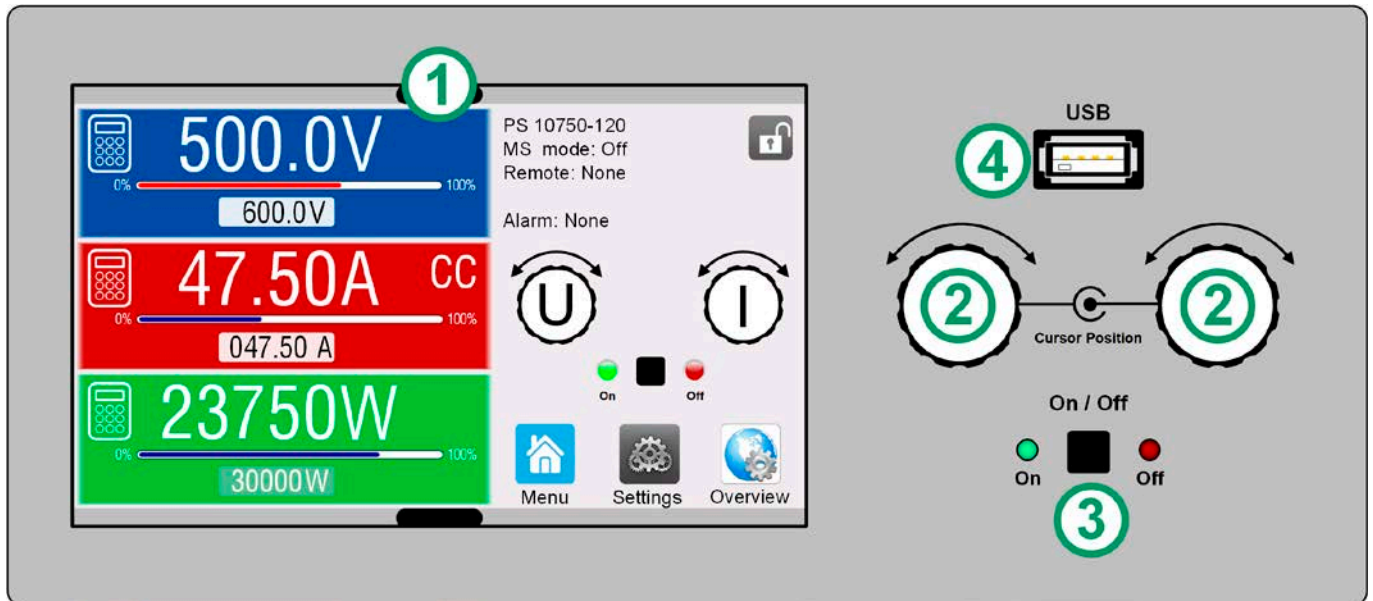

Figure 1 - Control Panel

Overview of the elements on the control panel

For a detailed description see section "1.9.6. The control panel (HMI)".

(1)	<p>Touchscreen display</p> <p>Used for selection of set values, menus and settings, as well as display of actual values and status. The touchscreen can be operated with the fingers or with a stylus.</p>
(2)	<p>Rotary knob with push button function</p> <p>Left knob (turn): voltage set value adjustment</p> <p>Left knob (push): shift the decimal position (cursor) of the voltage value for adjustment</p> <p>Right knob (turn): current, power or resistance set value adjustment</p> <p>Right knob (push): shift the decimal position (cursor) of the currently selected value for adjustment</p>
(3)	<p>On/Off Button for DC output</p> <p>Used to toggle the DC output between on and off. The LEDs "On" and "Off" indicate the state of the DC output, no matter if the device is manually controlled or remotely.</p>
(4)	<p>Port for USB sticks</p> <p>For the connection of standard USB sticks. See section "1.9.6.5. USB port (front side)" for more details.</p>

1.9 Construction and function

1.9.1 General description

The electronic high performance power supplies of the PS 10000 4U series are especially suitable for industrial test which have a demand for high power. All models in this series have a rated power of 30 kW and offer high currents or high voltages to cover a broad spectrum of applications.

For remote control the devices are provided as standard with USB and Ethernet ports on the rear side, as well as a galvanically isolated analog interface. Via optional plug-in interface modules, other digital interfaces such as for RS232, Profibus, ProfiNet, ModBus TCP, CAN, CANopen or EtherCAT can be added. These enable the devices to be connected to standard industrial buses simply by changing or adding a small module. The configuration, if necessary at all, is simple.

In addition, the devices offer as standard the possibility for parallel connection in so-called Share bus operation for constant current sharing, plus a true master-slave connection with totaling of all actual values is also provided as standard. Operating in this way allows for up to 64 units to be combined to a single system with a total power of up to 1920 kW.

Alternatively to the standard air-cooled version there are also water-cooled available which are usually configured and offered in cabinet systems with a complete water cooling distribution inside. For DIY water-cooled systems single units can also be obtained upon request.

1.9.2 Block diagram

The block diagram illustrates the main components inside the device and their relationships.

There are digital, microprocessor controlled components (KE, DR, HMI), which can be target of firmware updates.

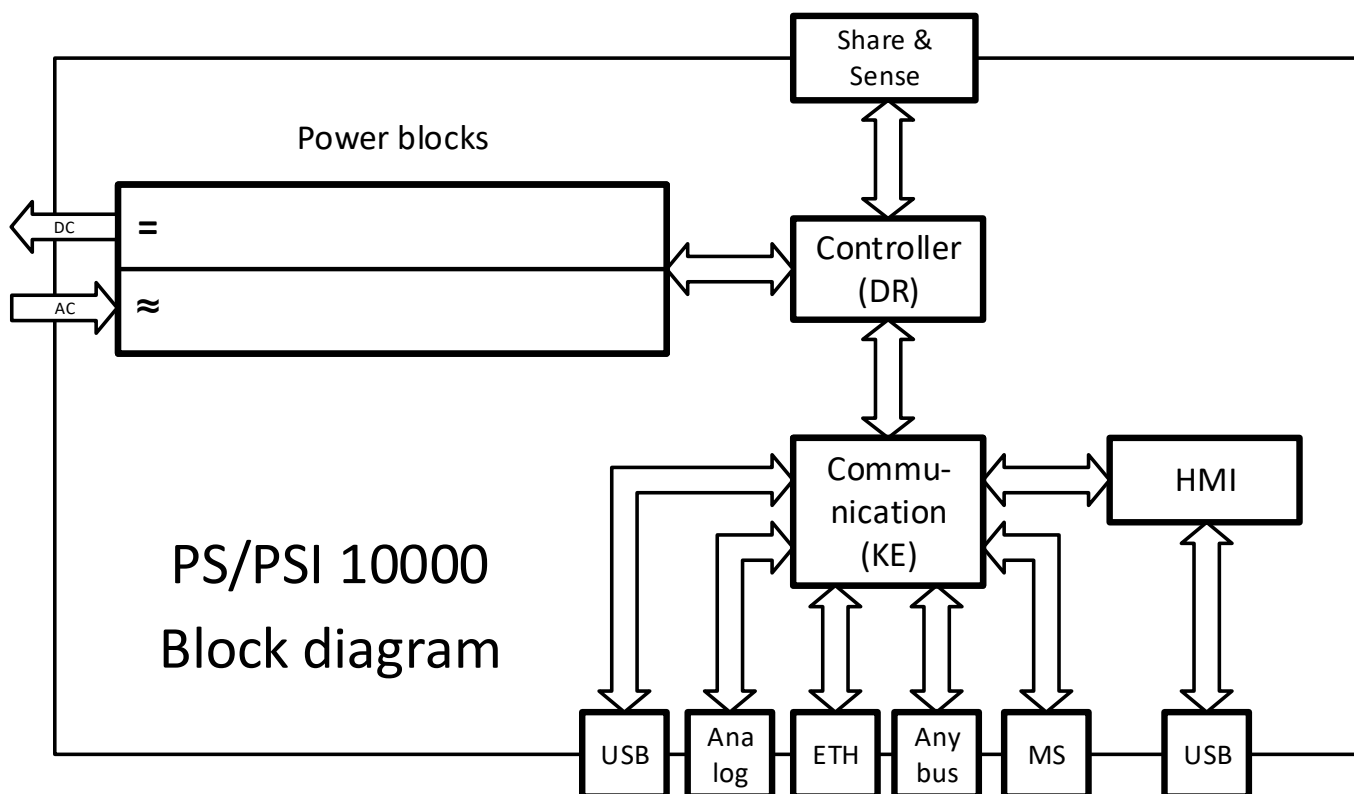

1.9.3 Scope of delivery

- 1 x Power supply device
- 2 x Remote sensing plugs
- 1 x 1.8 m (5.9 ft) USB cable
- 1 x Set of DC terminal covers
- 1 x Sense terminal cover
- 1 x USB stick with documentation and software
- 1 x AC connector plug (clamp type)
- 1 x Set for AC cable strain relief

1.9.4 Accessories

For these devices the following accessories are available:

IF-AB Digital interface modules	Pluggable and retrofittable digital interface modules for RS232, CANopen, Profibus, ProfiNet, ModBus TCP, EtherCAT or CAN are available. Details about the interface modules and the programming of the device using those interfaces can be found in separate documentation. It's usually available on the USB stick which is included with the device, or as PDF download on our website.
---	---

1.9.5 Options

These options are usually ordered along with the device, as they are permanently built in or preconfigured during the manufacturing process. Post-ordering of cabinet or retrofits upon request.

POWER RACKS 19"-rack	Racks in various configurations up to 42U as parallel systems are available, or mixed with electronic load devices to create test systems. Further information in our product catalogue, on our website or upon request
WC Water cooling	Replaces the standard cooling blocks of the internal power stages by three interconnected, water cooled blocks with two taps led out for supply. This options helps to avoid heating up the environment due to exhausted heat caused by a certain power dissipation. As a side effect, this type of cooling also reduces audible noise.

1.9.6 The control panel (HMI)

The HMI (**H**uman **M**achine **I**nterface) consists of a display with touchscreen, two rotary knobs, a pushbutton and an USB port.

1.9.6.1 Touchscreen display

The graphic touchscreen display is divided into a number of areas. The complete display is touch sensitive and can be operated by finger or stylus to control the equipment.

In normal operation the left hand side is used to show actual values and set values and the right hand side is used to display status information:

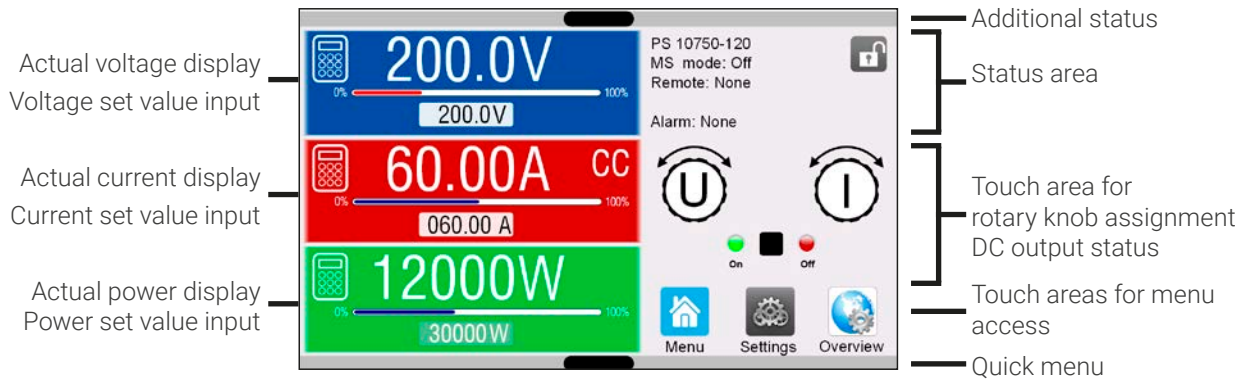

Touch areas may be enabled or disabled:



Black text = Enabled



Grey text = Touch area temporarily disabled

This applies to all touch areas. Some can additionally show a small padlock sign, indicating that the feature is permanently locked, usually due to a specific setting.

• Actual / set values area (left hand side)

In normal operation the DC output values (large numbers) and set values (small numbers) for voltage, current and power are displayed. The resistance set value of the simulated, variable internal resistance and its actual value are only visible while resistance mode is activated.

When the DC output is switched on the actual regulation mode is displayed as **CV**, **CC**, **CP** or **CR**, next to the corresponding actual values, as shown exemplary in the figure above with **CC**.

The set values can be adjusted with the rotary knobs next to the display screen or can be entered directly via the touchscreen. When adjusting with the knobs, pushing the knob will select the digit to be changed. Logically, the values are increased by clockwise turning and decreased by anti-clockwise rotation.





General display and setting ranges:

Display	Unit	Range	Description
Actual voltage	V	0.2-125% U_{Nom}	Actual values of DC output voltage
Set value of voltage ⁽¹⁾	V	0-102% U_{Nom}	Set value for limiting the DC output voltage
Actual current	A	0.2-125% I_{Nom}	Actual value of DC output current
Set value of current ⁽¹⁾	A	0-102% I_{Nom}	Set value for limiting the DC output current
Actual power	W, kW	0.2-125% P_{Nom}	Actual value of output power, $P = U * I$
Set value of power ⁽¹⁾	W, kW	0-102% P_{Nom}	Set value for limiting DC output power
Actual resistance	Ω	0-99999 / ∞	Actual value of the internal resistance
Set value of internal resistance ⁽¹⁾	Ω	$x^{(1)}$ -102% R_{Max}	Set value for the simulated internal inline resistance
Adjustment limits	ditto	0-102% nom	U-max, I-min etc., related to the physical values
Protection settings	ditto	0-110% nom	OVP, OCP etc., related to the physical values

⁽¹⁾ The lower limit for resistance set value varies. See tables in section 1.8.3

• **Status display (upper right)**

This area displays various status texts and symbols:

Display	Description
	The HMI is locked
	The HMI is unlocked
Remote:	The device is under remote control from....
Analogthe built-in analog interface
ETHthe built-in Ethernet interface
USB & othersthe built-in USB port or a plug in interface module
Local	The device has been locked by the user explicitly against remote control
Alarm:	Alarm condition which has not been acknowledged or still exists.
MS mode: Master (n SI)	Master-slave mode activated, device is master of n slaves
MS mode: Slave	Master-slave mode activated, device is slave
 / 	Data logging to USB stick active or failed

• **Area for assigning the rotary knobs**

The two rotary knobs next to the display screen can be assigned to various functions. This area shows the actual assignments. These can be changed by tapping this area, as long as it's not locked. The display changes to:

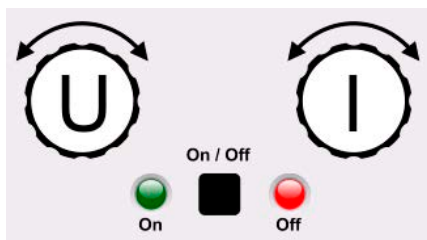

The physical quantities on the depiction of the knob shows the current assignment. With a power supply, the left knob is always assigned to the voltage U, while the right knob can be switched by tapping the depiction.

The area will then show the assignment:

U I
 Left rotary knob: voltage
 Right rotary knob: current

U P
 Left rotary knob: voltage
 Right rotary knob: power

U R
 Left rotary knob: voltage
 Right rotary knob: resistance

The other set values can't be adjusted via the rotary knobs, unless the assignment is changed. However, values can be entered directly with a ten-key pad by tapping on the small icon . Alternatively to the knob depiction, the assignment can also be changed by tapping the colored set value areas.

1.9.6.2 Rotary knobs

 As long as the device is in manual operation, the two rotary knobs are used to adjust set values in the main screen. For a detailed description of the individual functions see section "3.4. Manual operation".

1.9.6.3 Pushbutton function of the knobs

The rotary knobs also have a pushbutton function which is used in all value adjustment to move the cursor by rotation as shown:

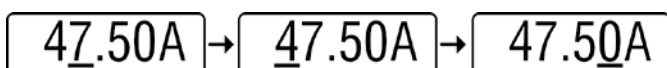

1.9.6.4 Resolution of the displayed values

In the display, set values can be adjusted in fixed increments. The number of decimal places depends on the device model. The values have 4 or 5 digits. Actual and set values always have the same number of digits.

Adjustment resolution and number of digits of set values in the display:

Voltage, OVP, U-min, U-max			Current, OCP, I-min, I-max			Power, OPP, P-max			Resistance, R-max		
Nominal	Digits	Min. increment	Nominal*	Digits	Min. increment	Nominal*	Digits	Min. increment	Nominal	Digits	Min. increment
≤ 80 V	4	0.01 V	<100 A	4	0.01 A	30000 W	5	1 W	<10 Ω	5	0.0001 Ω
200 V	5	0.01 V	>100 A	4	0.1 A	MS <100 kW	4	0.01 kW	≥10 Ω ... <100 Ω	5	0.001 Ω
360 V	4	0.1 V	≥1000 A	5	0.1 A	MS >100 kW	4	0.1 kW	≥100 Ω ... <1000 Ω	5	0.01 Ω
500 V	4	0.1 V	MS ≥3000 A	4	1 A	MS >1000 kW	4	1 kW	>1000 Ω	5	0.1 Ω
750 V	4	0.1 V	MS >10000 A	5	1 A						
≥1000 V	5	0.1 V									

* MS = master-slave

1.9.6.5 USB port (front side)

The frontal USB port, located above the rotary knobs, is intended for the connection of standard USB sticks and can be used for recording measured data during running operation or to load profiles.

USB 2.0 sticks are widely accepted. USB 3.0 sticks work, but not from all manufacturers. The stick must be **FAT32** formatted and should have a **maximum capacity of 32 GB**. All supported files must be held in a designated folder in the root path of the USB drive in order to be found. This folder must be named **HMI_FILES**, such that a PC would recognize the path G:\HMI_FILES if the drive were to be assigned the letter G.

The control panel of the device can read the following file types and names from a stick:

File name	Description
profile_<your_text>.csv	Previously saved user profile. A max. of 10 files to select from is shown when loading a user profile.

The control panel of the device can save the following file types and names to an USB stick:

File name	Description
usb_log_<nr>.csv	File with log data recorded during normal operation in all modes. The file layout is identical to the those generated from the Logging feature in EA Power Control. The <nr> field in the file name is automatically counted up if equally named files already exist in the folder.
profile_<nr>.csv	Saved user profile. The number in the file name is a counter and not related to the actual user profile number in the HMI. A max. of 10 files to select from is shown when loading a user profile.

1.9.7 USB port (rear side)

The USB-B port on the back side of the device is provided for communication with the device and for firmware updates. The included USB cable can be used to connect the device to a PC (USB 2.0 or 3.0). The driver is delivered with the device and installs a virtual COM port. Details for remote control can be found on the web site of the manufacturer or on the included USB stick.

The device can be addressed via this port either using the international standard Mod-Bus RTU protocol or by SCPI language. The device recognizes the message protocol used automatically.

If remote control is in operation the USB port has no priority over either the interface module (see below) or the analog interface and can, therefore, only be used alternatively to these. However, monitoring is always available.

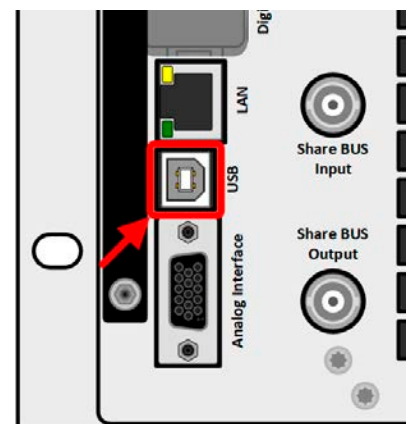

Figure 2 - USB port

1.9.8 Interface module slot

This slot on the rear side of the device is can receive various modules of the IF-AB interface series. The following options are available:

Article nr	Name	Description
35400100	IF-AB-CANO	CANopen, 1x Sub-D 9pole male
35400101	IF-AB-RS232	RS 232, 1x Sub-D 9pole male (null modem)
35400103	IF-AB-PBUS	Profibus DP-V1 Slave, 1x Sub-D 9pole female
35400104	IF-AB-ETH1P	Ethernet, 1x RJ45
35400105	IF-AB-PNET1P	ProfiNET IO, 1x RJ45
35400107	IF-AB-MBUS1P	ModBus TCP, 1x RJ45
35400108	IF-AB-ETH2P	Ethernet, 2x RJ45
35400109	IF-AB-MBUS2P	ModBus TCP, 2x RJ45
35400110	IF-AB-PNET2P	ProfiNET IO, 2x RJ45
35400111	IF-AB-CAN	CAN 2.0 A / 2.0 B, 1x Sub-D 9-pole, male
35400112	IF-AB-ECT	EtherCAT, 1x RJ45

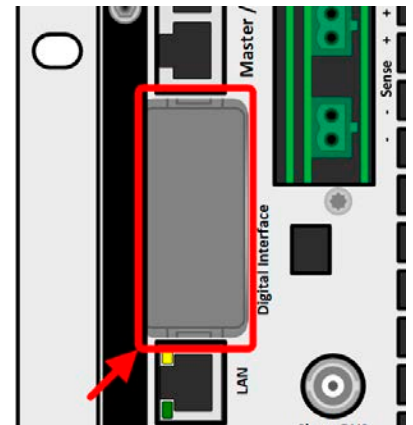

Figure 3 - Interface module slot

The modules are installed by the user and can be retrofitted without problem. A firmware update of the device may be necessary in order to recognize and support certain modules.

If remote control is in operation the interface module has no priority over either the USB port or the analog interface and can, therefore, only be used alternately to these. However, monitoring is always available.



Switch off device before adding or removing modules!

1.9.9 Analog interface

This 15-pole Sub-D socket on the back side of the device is provided for remote control of the device via analog or digital signals.

If remote control is in operation this analog interface can only be used alternately to the digital interface. However, monitoring is always available.

The input voltage range of the set values and the output voltage range of the monitor values, as well as reference voltage level can be switched in the settings menu of the device between 0-5 V and 0-10 V, in each case for 0-100%.

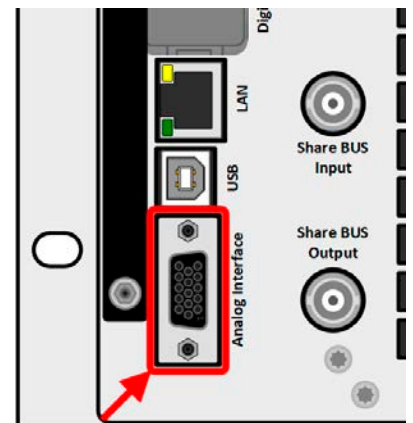

Figure 4 - Analog interface

1.9.10 "Share BUS" connector

The two BNC sockets (50 Ω type) labeled "Share BUS" form a digital, passed-through Share bus. This bus is bidirectional and connects the bus master unit via "Share BUS Output" to the next slave unit ("Share BUS Input") etc., for use in parallel operation (master-slave). BNC cables of suitable length can be obtained from us or electronics stores.

Basically, all 10000 series are compatible on this Share bus, though only connection of the same device type, i. e. power supply with power supply or electronic load with electronic load is supported by the devices for master-slave.

For a PS 10000 series device, different or identical PS 10000 series models can be used as slave units. A PS 10000 device can furthermore be the slave of PSI 10000 series devices.

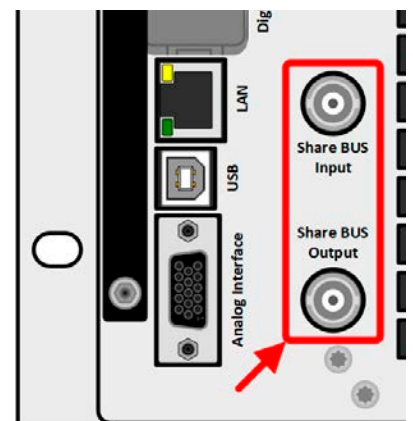

Figure 5 - Share bus

1.9.11 "Sense" connector (remote sensing)

In order to compensate for voltage drops along the DC cables to the load or external source, the Sense input (2 plugs included in delivery, one each for positive and negative pole) can be connected to the load resp. external source. The maximum possible compensation is given in the technical specifications.



In a master-slave system it's intended to wire remote sensing only to the master which would then forward the compensation to the slaves via Share BUS.



The Sense cover must be installed during operation, because there can be hazardous voltage on the sense lines! Reconfiguration on the Sense terminals is only permissible if the device is disconnected from AC supply and all DC sources!

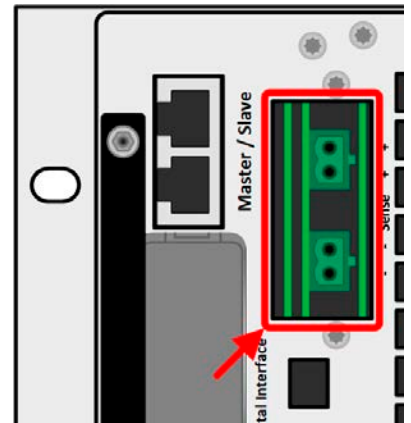

Figure 6 - Remote sensing terminals

1.9.12 Master-Slave bus

A further port is provided on the back side of the device, comprising two RJ45 sockets, which enables multiple identical devices to be connected via a digital bus (RS485) to create a master-slave system. Connection is made using standard CAT5 cables. These can theoretically have a length of up to 1200 m, but it's recommended to keep the connections as short as possible.

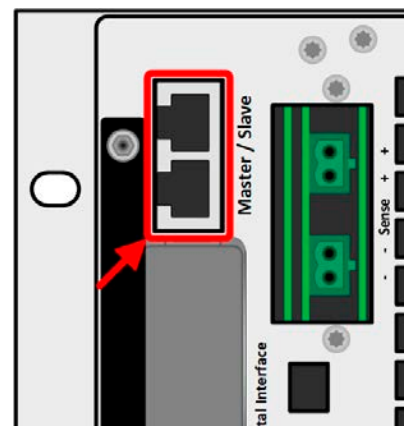

Figure 7 - Master slave bus ports

1.9.13 Ethernet port

The RJ45 LAN/Ethernet port on the rear side of the device is provided for communication with the device in terms of remote control or monitoring. The user has basically two options of access:

1. A website (HTTP, port 80) which is accessible in a standard browser via the IP or the host name given for the device. This website offers a configuration page for network parameters, as well as an input box for SCPI commands to control the device remotely by manually entering commands.
2. TCP/IP access via a freely selectable port (except 80 and other reserved ports). The standard port for this device is 5025. Via TCP/IP and the selected port, communication to the device can be established in most of the common programming languages.

Using this LAN port, the device can either be controlled by commands from SCPI or ModBus RTU protocol, while automatically detecting the type of message.

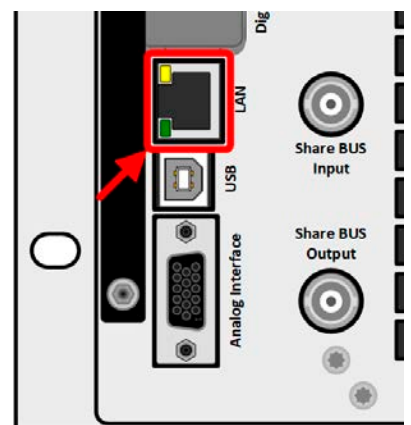

Figure 8 - LAN port

Access via ModBus TCP protocol is only supported by the optionally and separately available ModBus TCP interface module. See "1.9.8. Interface module slot".

The network setup can be done manually or by DHCP. Transmission speed and duplex mode are on automatic mode.

If remote control is in operation the Ethernet port has no priority over any other interface and can, therefore, only be used alternatively to these. However, monitoring is always available.

1.9.14 Water cooling

Contrary to the standard air-cooled versions of the models in this series, water cooling is optionally available. It's built in during the manufacturing process, so retrofitting isn't possible. Cooling the device with water instead of air cooling comes with a few advantages:

- Less ambient noise generated by the device (no fans running)
- Better cooling at higher ambient temperatures
- No direct dissipation of heat into the ambiance of the device

However, there also disadvantages:

- The device isn't allowed to run under load without active water flow
- Water flow inside an electronic device includes a higher risk of damage caused by a leak or by condensation of water from air humidity (dewing)

The water taps are located on the rear side of the device, also see the rear view drawing in section 1.8.4. Details about the connection, requirements and use of the water cooling can be found in section 2.3.4.

2. Installation & commissioning

2.1 Transport and storage

2.1.1 Transport



- The handles on the front and rear side of the device are **not** for carrying!
- Because of its weight, transport by hand should be avoided where possible. If unavoidable then only the housing should be held and not on the exterior parts (handles, DC output, rotary knobs).
- Do not transport when switched on or connected!
- When relocating the equipment use of the original packing is recommended
- The device should always be carried and mounted horizontally
- Use suitable safety clothing, especially safety shoes, when carrying the equipment, as due to its weight a fall can have serious consequences.

2.1.2 Packaging

It's recommended to keep the complete transport packaging for the lifetime of the device for relocation or return to the manufacturer for repair. Otherwise the packaging should be disposed of in an environmentally friendly way.

2.1.3 Storage

In case of long term storage of the equipment it's recommended to use the original packaging or similar. Storage must be in dry rooms, if possible in sealed packaging, to avoid corrosion, especially internal, through humidity.

2.2 Unpacking and visual check

After every transport, with or without packaging, or before commissioning, the equipment should be visually inspected for damage and completeness using the delivery note and/or parts list (see section "1.9.3. Scope of delivery"). An obviously damaged device (e.g. loose parts inside, damage outside) must under no circumstances be put in operation.

2.3 Installation

2.3.1 Safety procedures before installation and use



- The device has a considerable weight. Therefore the proposed location of the equipment (table, cabinet, shelf, 19" rack) must be able to support the weight without restriction.
- When using a 19" rack, rails suitable for the width of the housing and the weight of the device are to be used (see "1.8.3. Specific technical data")
- Before connecting to the mains ensure that the supply voltage is as shown on the product label. Over-voltage on the AC supply can cause equipment damage.

2.3.2 Preparation

2.3.2.1 Selecting cables

The required AC supply connection for these device is termination. It's done via the 5 pole AC connector on the rear (AC filter box). A matching plug is included. Wiring of the plug is at least 4 wire (3x L, PE) of suitable cross section and length. Full configuration with all phases plus N and PE is permissible.

For recommendations for a cable cross section see "2.3.5. Connection to AC supply". Dimensioning of the DC wiring to the load/consumer has to reflect the following:



- The cable cross section should always be specified for at least the maximum current of the device.
- Continuous operation at the approved limit generates heat which must be removed, as well as voltage loss which depends on cable length and heating. To compensate for these the cable cross section should be increased and the cable length reduced.

2.3.3 Installing the device



- Select the location for the device so that the connection to the load resp. source is as short as possible.
- Leave sufficient space, at least 30 cm (1 ft), behind the equipment for ventilation (only required for the standard air-cooled version)
- The device must not be operated without a proper touch protection for the AC connection, which is either only accomplished by installation of the device in a 19" rack/cabinet with lockable doors or by applying further measures (additional cover etc.)

A device in a 19" chassis will usually be mounted on suitable rails and installed in 19" racks or cabinets. The depth of the device and its weight must be taken into account. The handles on the front and rear are for help with sliding in and out of the cabinet. Slots on the front plate are provided for fixing the device (fixing screws not included).

The unacceptable positions, as shown below, are also valid for the vertical mount of the device onto a wall or inside a cabinet. The required air flow would be insufficient. This wouldn't actually apply to water cooled models, but the construction of the entire device isn't made for operation in this position.

Acceptable and unacceptable installation positions (air or water cooled, air cooled shown):

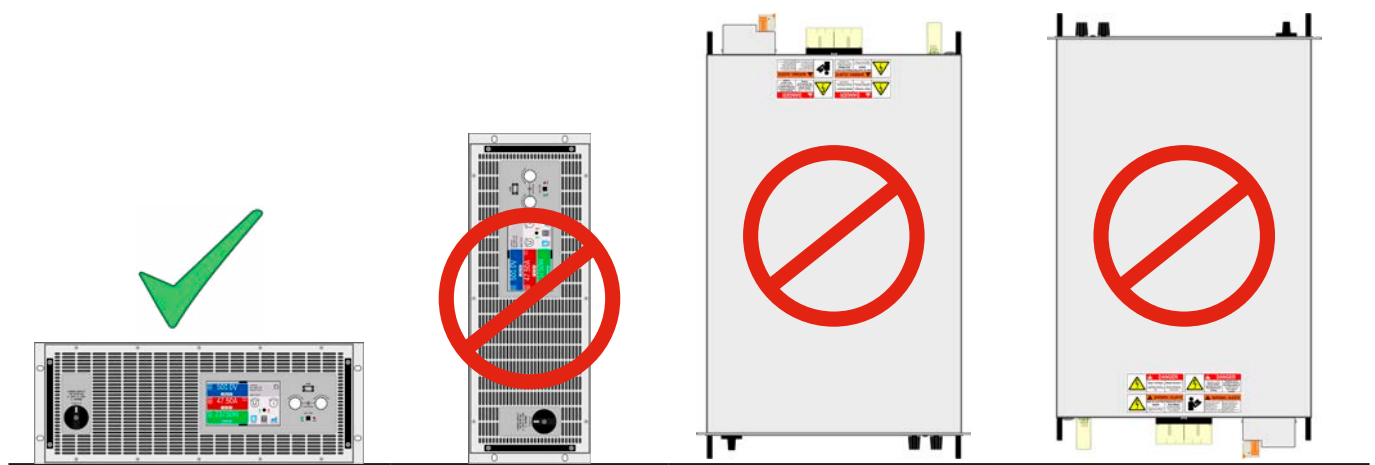

Standing surface

2.3.4 Installing the water cooling

If present, the water cooling should be connected and any further measures related to water cooling installation should be carried out before the AC supply for the device is connected, let alone the unit is powered. Correct installation and connection, test for watertightness and later operation lie in the sole responsibility of the operator or end user.

2.3.4.1 Requirements

The water pipe construction is identical with all models in this series but due to the rated current and hence different heat dissipation per minute in the internal cooling block, a model depending requirement to the water and the ambience must be met:

Model	60 V / 80 V	200 V to 2000 V
Internal water flow:	Series	Series
Ambient temperature:	Max. +50 °C (122 °F)	Max. +50 °C (122 °F)
Water intake temperature (min):	See dew point tables below	See dew point tables below
Water intake temperature (max):	+33 °C (82 °F)	+26 °C (91 °F)
Flow rate:	Min. 12 l/minute (3.17 gal/minute)	Min. 7 l/minute (1.85 gal/minute)
Corrosion protection:	Ethylene glycol	Ethylene glycol
Water hardness:	Soft (calcium carbonate < 2 mmol/l)	Soft (calcium carbonate < 2 mmol/l)
Water pressure:	Min. 1 bar (14 psi), max. 4 bar (58 psi)	Min. 1 bar (14 psi), max. 4 bar (58 psi)

2.3.4.2 Connection point

The device has three separate cooling blocks internally, each with its own water pipe. All pipes are led out and connected outside of the device. The water will thus flow through all three pipes in parallel. On the rear of the device are two taps (tee pieces) for water connection:

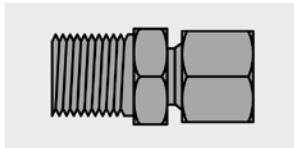

Tap: Thread M16x1.5

Which one of the two taps is used for intake and outlet is arbitrary. For later use it's only important to have a sufficient amount of water flowing through the pipes, along with a certain water intake temperature.

The hose connection is either directly done on the tee, using the metric thread, or by using a hose tail swivel, for example one from company Schwer Fittings, type SA-DKL90. This swivel is already sealing upon mount, using a 24° metal cone.

2.3.4.3 Operation and supervision

Once the water cooling is installed and running, there is one primary value left to supervise permanently, the so-called dew point. Depending on the temperature of water on the intake in combination with the humidity of ambient air and also the air inside the device water can condensate, i. e. dew inside the device. This must be avoided under all circumstances! It means, it might be required to have regulated water cooling system in order to react to varying ambient conditions.

The dew point is defined in several norms, for instance DIN 4108. The table below defines the dew point (air humidity to water) **in °C in the upper table** and **in °F in the lower table** at specific ambient temperatures and air humidity levels. The intake water temperature must always be higher than the dew point:

Ambient	Relative air humidity in per cent										
	45%	50%	55%	60%	65%	70%	75%	80%	85%	90%	95%
14°C	2.2	3.76	5.1	6.4	7.58	8.67	9.7	10.71	11.64	12.55	13.36
15°C	3.12	4.65	6.07	7.36	8.52	9.63	10.7	11.69	12.62	13.52	14.42
16°C	4.07	5.59	6.98	8.29	9.47	10.61	11.68	12.66	13.63	14.58	15.54
17°C	5	6.48	7.92	9.18	10.39	11.48	12.54	13.57	14.5	15.36	16.19
18°C	5.9	7.43	8.83	10.12	11.33	12.44	13.48	14.56	15.41	16.31	17.25
19°C	6.8	8.33	9.75	11.09	12.26	13.37	14.49	15.47	16.4	17.37	18.22
20°C	7.73	9.3	10.72	12	13.22	14.4	15.48	16.46	17.44	18.36	19.18
21°C	8.6	10.22	11.59	12.92	14.21	15.36	16.4	17.44	18.41	19.27	20.19
22°C	9.54	11.16	12.52	13.89	15.19	16.27	17.41	18.42	19.39	20.28	21.22
23°C	10.44	12.02	13.47	14.87	16.04	17.29	18.37	19.37	20.37	21.34	22.23
24°C	11.34	12.93	14.44	15.73	17.06	18.21	19.22	20.33	21.37	22.32	23.18
25°C	12.2	13.83	15.37	16.69	17.99	19.11	20.24	21.35	22.27	23.3	24.22
26°C	13.15	14.84	16.26	17.67	18.9	20.09	21.29	22.32	23.32	24.31	25.16
27°C	14.08	15.68	17.24	18.57	19.83	21.11	22.23	23.31	24.32	25.22	26.1
28°C	14.96	16.61	18.14	19.38	20.86	22.07	23.18	24.28	25.25	26.2	27.18

Ambient	Relative air humidity in per cent										
	45%	50%	55%	60%	65%	70%	75%	80%	85%	90%	95%
29°C	15.85	17.58	19.04	20.48	21.83	22.97	24.2	25.23	26.21	27.26	28.18
30°C	16.79	18.44	19.96	21.44	23.71	23.94	25.11	26.1	27.21	28.19	29.09
32°C	18.62	20.28	21.9	23.26	24.65	25.79	27.08	28.24	29.23	30.16	31.17
34°C	20.42	22.19	23.77	25.19	26.54	27.85	28.94	30.09	31.19	32.13	33.11
36°C	22.23	24.08	25.5	27	28.41	29.65	30.88	31.97	33.05	34.23	35.06
38°C	23.97	25.74	27.44	28.87	30.31	31.62	32.78	33.96	35.01	36.05	37.03
40°C	25.79	27.66	29.22	30.81	32.16	33.48	34.69	35.86	36.98	38.05	39.11
45°C	30.29	32.17	33.86	35.38	36.85	38.24	39.54	40.74	41.87	42.97	44.03
50°C	34.76	36.63	38.46	40.09	41.58	42.99	44.33	45.55	46.75	47.9	48.98

Ambient	Relative air humidity in per cent										
	45%	50%	55%	60%	65%	70%	75%	80%	85%	90%	95%
58°F	36	38.8	41.2	43.6	45.7	47.7	49.5	51.3	53	54.6	56.1
59°F	37.7	40.4	43	45.3	47.4	49.4	51.3	53.1	54.8	56.4	58
61°F	39.4	42.1	44.6	47	49.1	51.1	53.1	54.8	56.6	58.3	60
63°F	41	43.7	46.3	48.6	50.8	52.7	54.6	56.5	58.1	59.7	61.2
65°F	42.7	45.4	47.9	50.3	52.4	54.4	56.3	58.3	59.8	61.4	63.1
67°F	44.3	47	49.6	52	54.1	56.1	58.1	59.9	61.6	63.3	64.8
68°F	46	48.8	51.3	53.6	55.8	58	59.9	61.7	63.4	65.1	66.6
70°F	47.5	50.4	52.9	55.3	57.6	59.7	61.6	63.4	65.2	66.7	68.4
72°F	49.2	52.1	54.6	57.1	59.4	61.3	63.4	65.2	67	68.6	70.2
74°F	50.8	53.7	56.3	58.8	60.9	63.2	65.1	66.9	68.7	70.5	72.1
76°F	52.5	55.3	58	60.4	62.8	64.8	66.6	68.6	70.5	72.2	73.8
77°F	54	56.9	59.7	62.1	64.4	66.4	68.5	70.5	72.1	74	75.6
79°F	55.7	58.8	61.3	63.9	66.1	68.2	70.4	72.2	74	75.8	77.3
81°F	57.4	60.3	63.1	65.5	67.7	70	72.1	74	75.8	77.4	79
83°F	59	61.9	64.7	66.9	69.6	71.8	73.8	75.8	77.5	79.2	81
85°F	60.6	63.7	66.3	68.9	71.3	73.4	75.6	77.5	79.2	81.1	82.8
86°F	62.3	65.2	68	70.6	74.7	75.1	77.2	79	81	82.8	84.4
90°F	65.6	68.6	71.5	73.9	76.4	78.5	80.8	82.9	84.7	86.3	88.2
94°F	68.8	72	74.8	77.4	79.8	82.2	84.1	86.2	88.2	89.9	91.6
97°F	72.1	75.4	77.9	80.6	83.2	85.4	87.6	89.6	91.5	93.7	95.2
101°F	75.2	78.4	81.4	84	86.6	89	91.1	93.2	95.1	96.9	98.7
104°F	78.5	81.8	84.6	87.5	89.9	92.3	94.5	96.6	98.6	100.5	102.4
113°F	86.6	90	93	95.7	98.4	100.9	103.2	105.4	107.4	109.4	111.3
122°F	94.6	98	101.3	104.2	106.9	109.4	111.8	114	116.2	118.3	120.2

2.3.4.4 Notes

- The water flow should be started prior to powering the device, but at least prior to switching the DC terminal on

2.3.5 Connection to AC supply



- Connection to an AC supply must only be carried out by qualified personnel and the device must always be run directly on a power grid (transformer are permitted) and not on generators or UPS equipment!
- Cable cross section must be suitable for the maximum input current of the device! See tables below. The device should furthermore be fused externally and according to the current rating and cable cross section
- WC models: For safety reasons it's recommended to install a 30 mA RCD for every water-cooled unit (option WC) or at least one per three units (due to the possible leak current, see technical data), in case multiple WC models run in parallel

All models and variants in this series, as produced since approx. 01/2022, support to run either on 380/400/480 V or also 208 V (US and Japan grids). When running a model with 30 kW power rating on 208 V it would automatically switch into derated power mode in which the available DC power is decreased to 18 kW. This is detected every time when powering the device, so that the same model could provide the full 30 kW of rated power when being run on 380/400/480 V.

2.3.5.1 AC supply requirements

No matter what particular variant the device is, standard, WC or Slave, the rated AC supply voltage on the type label is decisive. They all use a regular three-phase supply without N. Specification:

Rated power	Inputs on AC plug	Supply type	Configuration
30 kW	L1, L2, L3, (N), PE	Three-phase (3P)	Delta



The PE conductor is imperative and must always be wired to the AC plug! There is furthermore a grounding point beneath the AC filter box which is required to be connected to PE via a separate PE line for the primary reason of grounding the enclosure in order achieve higher safety. As a secondary option it can be used to ground one of the DC terminal poles.

2.3.5.2 Cross section

For the selection of a suitable cable cross section, the rated AC current of the device and the cable length are decisive. Based on the connection of a **single unit** the table lists the maximum input current and recommended minimum cross section for each phase:

Rated power	L1		L2		L3		PE ⁽¹⁾
	∅	I _{max}	∅	I _{max}	∅	I _{max}	∅
30 kW (rated) at 380/400/480 V	≥10 mm ²	56 A	≥10 mm ²	56 A	≥10 mm ²	56 A	≥10 mm ²
18 kW (derated) at 208 V	(AWG8)		(AWG8)		(AWG8)		(AWG8)

2.3.5.3 AC plug & AC cable

The included connection plug can receive cable ends of up to 25 mm². The longer the connection cable, the higher the voltage loss due to the cable resistance. Therefore the mains cable should be kept as short as possible or have an even bigger cross section. Cables with 4 or 5 conductors can be used. When using a cable with N conductor, it's allowed to clamp it into the spare pin of the AC plug. Ratings of the AC plug:

- Max. cross section without cable end sleeve: 25 mm² (AWG4)
- Max. wire cross section with cable end sleeve: 16 mm² (AWG10)
- Stripping length without cable end sleeve: 18-20 mm (0.75 in)

¹ Valid for both, the ground conductor in the AC cable and the separate PE line for enclosure grounding

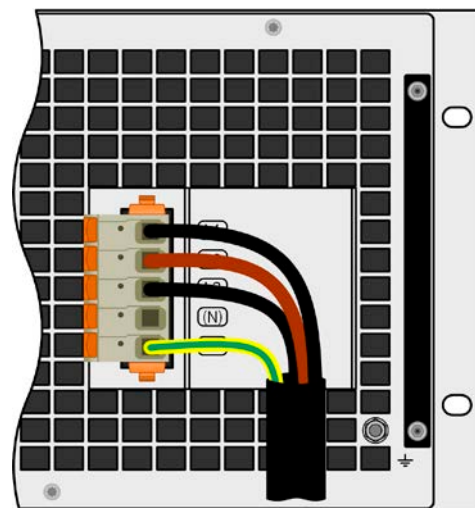
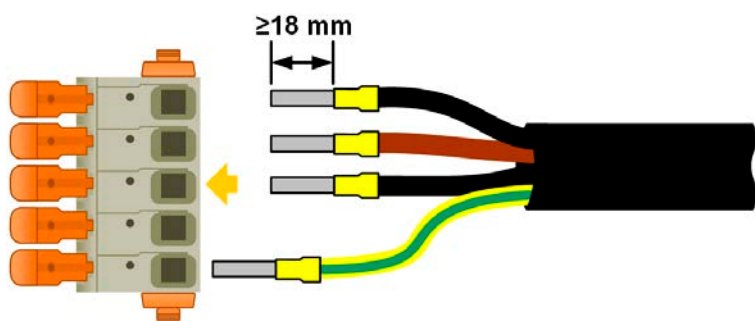

Figure 9 - Example for an AC cable with 4 conductors (European color code, cable not included in delivery)

2.3.5.4 Mounting the strain relief

All models and variants include a strain relief for the AC cable in their scope of delivery. This strain relief is recommended to be mounted and used by the installer, unless a different kind of strain relief is intended and installed. Installation steps:

1. Remove the two screws from the AC filter box as marked in *Figure 10* below.
2. Place the bracket and fix it with the included, longer screws (M3x8) and spring/curved washers.
3. Plug the AC plug and lead the cable in front of the bracket, when seen from behind, and fix it with at least one, better both of the included cable ties.

The bracket and the cable ties can remain connected all the time. The AC plug has some space to be pulled if required. Should the device be removed from the installation (cabinet), it's recommended to only pull the plug and dismount the bracket.

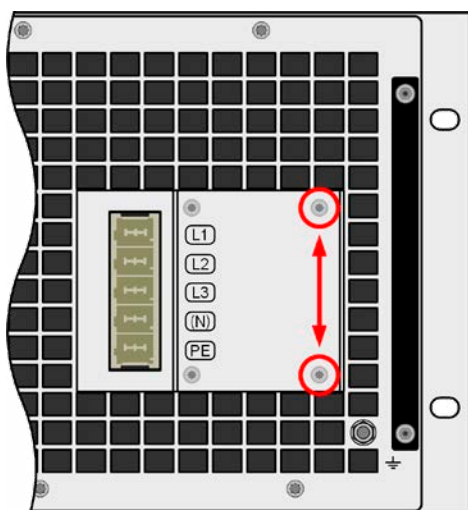

Figure 10 - Mounting position of the bracket

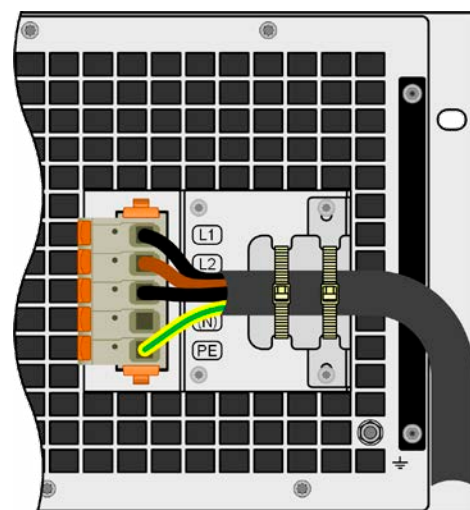

Figure 11 - Fully installed strain relief

2.3.5.5 Grounding the enclosure

All devices feature an extra grounding point on the rear side, as depicted in the figure to the right, also marked as "7" or "8" in "1.8.4. Views".

For reasons of safety for people working with the device which, amongst other measures, is achieved by keeping the leakage current as low as possible, the enclosure must be grounded. It requires a separate protective earth line (PE), being connected to the grounding point. The cross section of that line must be at least the same as with the ground conductor in the AC supply cable.



Figure 12 - Grounding point

2.3.6 Connection to DC loads



- In the case of a device with a high nominal DC current and hence a thick and heavy DC connection cable it's necessary to take account of the weight of the cable and the strain imposed on the DC connection. Especially when mounted in a 19" cabinet or similar, where the cable could hang on the DC terminal, a strain reliever should be used.
- Besides the proper cross section of DC cables the proper electric strength (withstand voltage) of the cables must be considered.



No false polarity protection inside! Loads which are also sources, such as batteries, will damage the device when connected with false polarity, also when not the device isn't powered!



When connected to DC, a load that is also a source charges the internal capacities on the DC terminal, even when the device isn't powered. Dangerous voltage levels can be present on the DC terminal, also after disconnection of that external source.

The DC output terminal is on the rear side of the device and isn't protected by a fuse. The cross section of connection cables is depending on the current consumption, cable length and ambient temperature.

For cables **up to 5 m (16.4 ft)** and average ambient temperature **up to 30°C (86°F)**, we recommend:

up to 40 A :	6 mm ² (AWG8)	up to 60 A :	16 mm ² (AWG4)
up to 80 A :	25 mm ² (AWG3)	up to 120 A :	35 mm ² (AWG1/0)
up to 180 A :	70 mm ² (AWG2/0)	up to 240 A :	2x 35 mm ² (AWG1/0)
up to 420 A :	2x 95 mm ² (AWG3/0)	up to 1000 A :	3x 185 mm ² (AWG400)

per connection pole (multi-conductor, insulated, openly suspended). Single cables of, for example, 70 mm² may be replaced by e.g. 2x 35 mm² etc. If the cables are long then the cross section must be increased to avoid voltage loss and overheating.

2.3.6.1 DC terminal types

The table below shows an overview of the various DC terminals. It's recommended that connection of load cables always utilizes flexible cables with ring lugs.

Type 1: Models up to 200 V	Type 2: Models from 360 V
M10 bolt on a metal rail Recommendation: ring lug with a 11 mm hole	M6 bolt on a metal rail Recommendation: ring lug with a 6.5 mm hole

2.3.6.2 Cable lead and plastic cover

Models from 360 V rating and with type 2 DC terminal have a plastic cover for contact protection included. It should always be installed. There are breakouts so that the DC cable can be laid in various directions.



The connection angle and the required bending radius for the DC cable must be taken into account when planning the depth of the complete device, especially when installing in a 19" cabinet or similar installations.

Examples for the type 1 terminal:

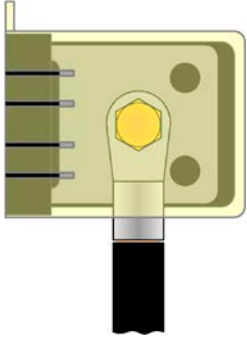

- 90° up or down
- space saving in depth
- no bending radius

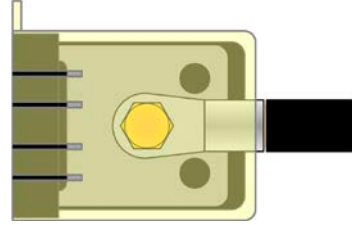

- horizontal lead
- space saving in height
- large bending radius

2.3.7 Grounding of the DC output

Besides the main purpose of grounding the enclosure, the extra grounding point (item "7" in 1.8.4.3 or "8" in 1.8.4.8, also marked in the figure to the right) can also be used to ground any the DC terminal poles. Doing so causes a potential shift on the opposite pole against PE. Because of insulation, there is a maximum allowed potential shift defined for the negative DC terminal pole, which depends on the device model. Refer to "1.8.3. Specific technical data" for details.

Both poles on the DC terminal are floating, which is considered as a basic protection in terms of human body safety. Grounding any DC terminal voids that basic protection.



When potential shifting the model with 60 V rating, the safety extra low voltage (SELV) can turn into a protective extra low voltage (PELV) or leave the safe range. In such a situation, the voltage levels on the DC terminal become hazardous and thus the DC terminal must be covered.



In case any DC pole is grounded, the operator of the device must reinstate the basic protection for human safety by installing appropriate external means, for instance a cover, everywhere the potential of the DC terminal is connected to.

2.3.8 Connection of remote sense



- Remote sensing is only effective during constant voltage operation (CV) and for other regulation modes the sense input should be disconnected, if possible, because connecting it generally increases the oscillation tendency
- The cross section of the sense cables is noncritical. Recommendation for cables up to 5 m (16.4 ft): use at least 0.5 mm²
- Sense cables shouldn't be twisted, but laid close to the DC cables, i. e. Sense- cable close to DC- cable to the load etc. to damp or avoid possible oscillation. If necessary, an additional capacitor should be installed at the load/consumer to eliminate oscillation
- The Sense+ cable must be connected to DC+ on the load and Sense- to DC- at the load, otherwise the sense input of the power supply can be damaged. For an example see Figure 13 below.
- In master-slave operation, the remote sensing must be connected to the master unit only
- The dielectric strength of the sense wires must always at least match the DC voltage rating!



Dangerous voltage on the sense terminals! The sense cover must always be installed.

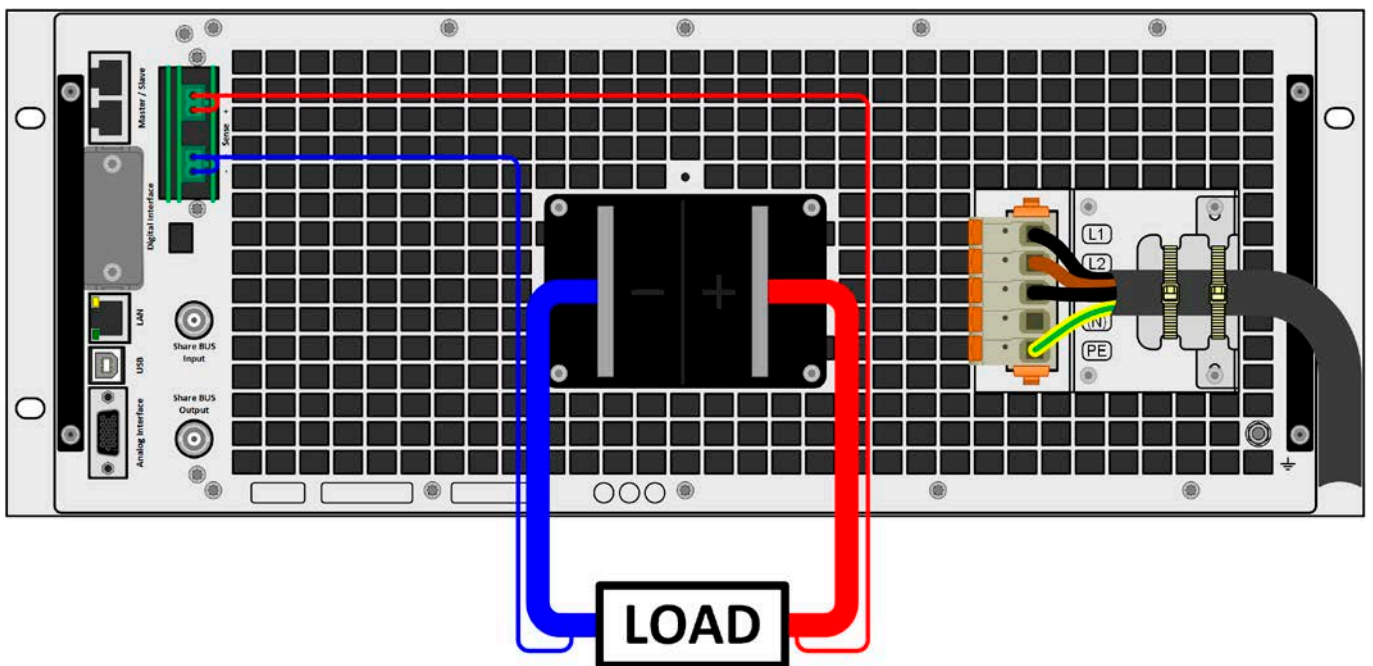
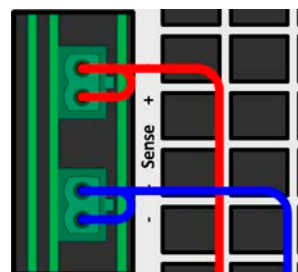
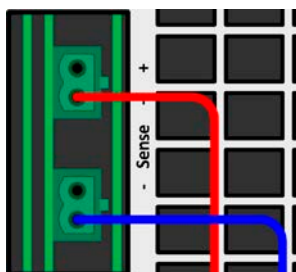
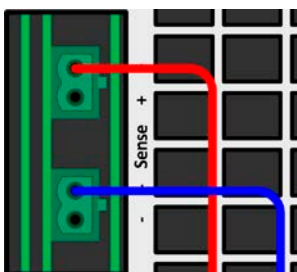

Figure 13 - Example for remote sensing wiring (DC terminal and Sense terminal covers left way for illustrative purposes)

Allowed connection schemes:



2.3.9 Installation of an interface module

The optionally obtainable interface modules can be retrofitted by the user and are exchangeable with each other. The settings for the currently installed module vary and need to be checked and, if necessary, corrected on initial installation and after module exchange.



- Common ESD protection procedures apply when inserting or exchanging a module.
- The device must be switched off before insertion or removal of a module
- Never insert any other hardware other than an interface module into the slot
- If no module is in use it's recommended that the slot cover is mounted in order to avoid internal dirtying of the device and changes in the air flow (standard models with air-cooling)

Installation steps:

1.

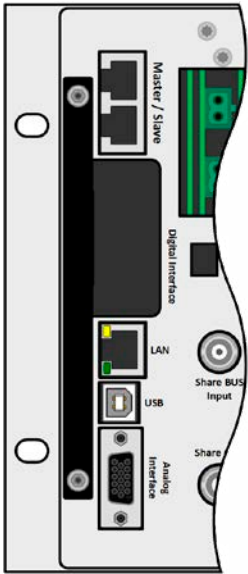

Remove the slot cover. If needed, use a screw driver.

2.

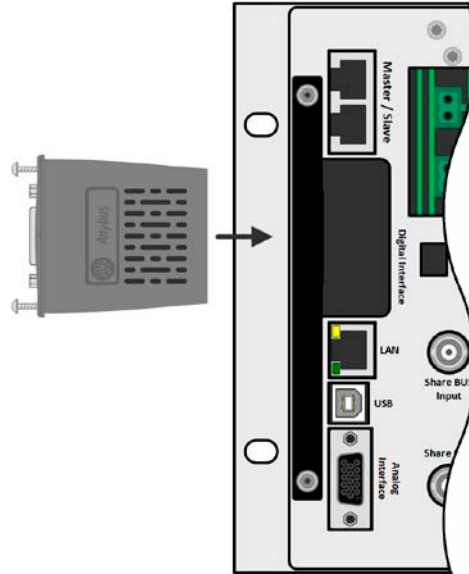

Insert the interface module into the slot. The shape ensures correct alignment.

When inserting take care that it's held as close as possible to a 90° angle to the rear wall of the device. Use the green PCB which you can recognize on the open slot as guide. At the end is a socket for the module.

On the bottom side of the module are two plastic nibs which must click into the green board (PCB) so that the module is properly aligned on the rear wall of the device.

3.

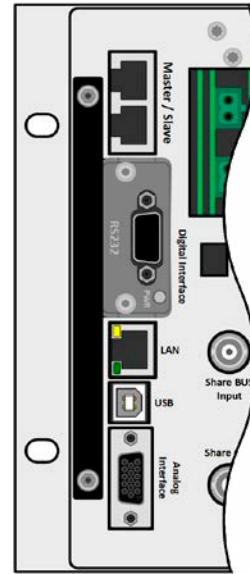

The screws (Torx 8) are provided for fixing the module and should be fully screwed in. After installation, the module is ready for use and can be connected.

Removal follows the reverse procedure. The screws can be used to assist in pulling out the module.

2.3.10 Connecting the analog interface

The 15-pole connector (Type: Sub-D, D-Sub) on the rear side is an analog interface. To connect this to a controlling hardware (PC, electronic circuit), a standard plug is necessary (not included in the scope of delivery). It's generally advisable to switch the device completely off before connecting or disconnecting this connector, but at least the DC output.

2.3.11 Connecting the Share bus

The "Share BUS" connectors on the rear side (2x BNC type) can be used to connect to the Share bus of further units. The main purpose of the Share bus is to balance the voltage of multiple units in parallel operation. For further information about parallel operation refer to section "3.10.1. Parallel operation in master-slave (MS)".

For the connection of the share bus the following must be paid attention to:



Connection is only permitted between compatible devices (see "1.9.10. "Share BUS" connector" for details) and between a max. of 64 units

2.3.12 Connecting the USB port (rear side)

In order to remotely control the device via this port, connect the device with a PC using the included USB cable and switch the device on.

2.3.12.1 Driver installation (Windows)

On the initial connection with a PC the operating system will identify the device as new hardware and will try to install a driver. The required driver is for a Communication Device Class (CDC) device and is usually integrated in current operating systems such as Windows 7 or 10. But it's strongly recommended to use the included driver installer (on USB stick) to gain maximum compatibility to our softwares.

2.3.12.2 Driver installation (Linux, MacOS)

We can't provide drivers or installation instructions for these operating systems. Whether a suitable driver is available is best carried out by searching the Internet.

2.3.12.3 Alternative drivers

In case the CDC drivers described above are not available on your system, or for some reason do not function correctly, commercial suppliers can help. Search the Internet for suppliers using the keywords "cdc driver windows" or "cdc driver linux" or "cdc driver macos".

2.3.13 Initial commission

For the first start-up after installation of the device, the following procedures have to be executed:

- Confirm that the connection cables to be used are of a satisfactory cross section!
- Check if the factory settings of set values, safety and monitoring functions and communication are suitable for your intended application of the device and adjust them if required, as described in the manual!
- In case of remote control via PC, read the additional documentation for interfaces and software!
- In case of remote control via the analog interface, read the section in this manual concerning analog interfaces!

2.3.14 Commission after a firmware update or a long period of non-use

In case of a firmware update, return of the equipment following repair or a location or configuration change, similar measures should be taken to those of initial start up. Refer to "2.3.13. Initial commission".

Only after successful checking of the device as listed may it be operated as usual.

3. Operation and application

3.1 Personal safety



- In order to guarantee safety when using the device, it's essential that only persons operate the device who are fully acquainted and trained in the required safety measures to be taken when working with dangerous electrical voltages
- For models which can generate a voltage which is dangerous by contact, or is connected to such, the included DC terminal cover, or an equivalent, must always be used
- Whenever the load and DC output are being re-configured, the device should be disconnected from the mains, not only the DC output switched off!

3.2 Operating modes

A power supply is internally controlled by different control circuits, which shall regulate voltage, current and power to the adjusted values and hold them constant, if possible. These circuits follow typical laws of control systems engineering, resulting in different operating modes. Each operating mode has its own characteristics which are explained below in short form.



- *Unloaded operation isn't considered as a normal operation mode and can thus lead to false measurements, for example when calibrating the device*
- *The optimal working point of the device is between 50% and 100% voltage and current*
- *It's recommended to not run the device below 10% voltage and current, in order to meet technical values like ripple or transient times*

3.2.1 Voltage regulation / Constant voltage

Voltage regulation is also called constant voltage operation (CV).

The DC output voltage of a power supply is held constant on the adjusted value, unless the output current or the output power according to $P = U_{OUT} * I_{OUT}$ reaches the adjusted current or power limit. In both cases the device will automatically change to constant current or constant power operation, whatever occurs first. Then the output voltage can't be held constant anymore and will sink to a value resulting from Ohm's law.

While the DC output is switched on and constant voltage mode is active, then the condition "CV mode active" will be indicated on the graphic display by the abbreviation CV and this message will be passed as a signal to the analog interface, as well stored as status which can also be read as a status message via digital interface.

3.2.1.1 Voltage regulation peaks

When working in constant voltage regulation (CV), the device's internal voltage regulator requires a small transient time to settle the voltage after a load step. Negative load steps, i.e. high load to lower load, will cause the output voltage to overshoot for a short time until compensated by the voltage regulator. The time it takes to settle the voltage can be influenced by switching the voltage regulation speed between the settings **Slow**, **Normal** and **Fast**, whereas Normal is the default. Setting **Slow** will result in a higher transient time and higher voltage drop, but less overshooting, while **Fast** is vice versa. Also see "3.4.3.1. Sub menu "Settings".

Depictions:

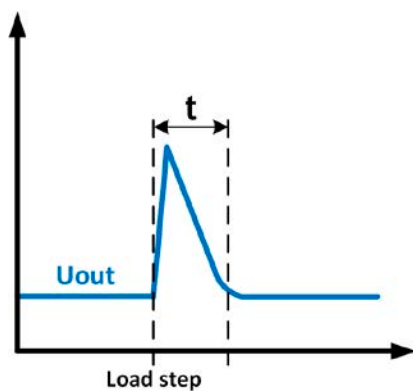

Example for a neg. load step: the DC output will rise above the adjusted value for a short time. t = transient time to settle the output voltage.

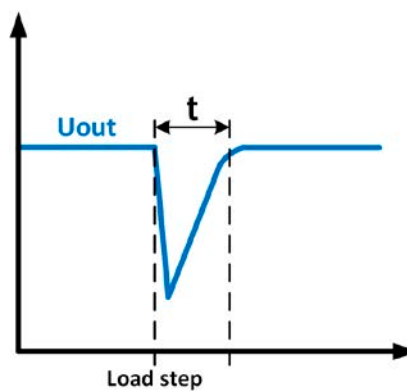

Example for a pos. load step: the DC output will collapse below the adjusted value for a short time. t = transient time to settle the output voltage.

3.2.2 Current regulation / constant current / current limiting

Current regulation is also known as current limiting or constant current mode (CC).

The DC output current is held constant by the power supply, once the output current to the load reaches the adjusted limit. Then the power supply automatically switches to CC. The current flowing from the power supply is determined by the output voltage and the load's true resistance. As long as the output current is lower than the adjusted current limit, the device will be either in constant voltage or constant power mode. If, however, the power consumption reaches the adjusted power value, the device will switch automatically to power limiting and sets the output current according to $I_{MAX} = P_{SET} / U_{IN}$, even if the maximum current value is higher. The current set value, as determined by the user, is always an upper limit.

While the DC output is switched on and constant current mode is active, the condition "CC mode active" will be indicated on the graphic display with abbreviation **CC** and this message will be passed as a signal to the analog interface, as well stored as status which can also be read as a status message via digital interface.

3.2.2.1 Voltage overshootings

In certain situations it's possible that the device generates a voltage overshooting. Such situations are when the device is in CC, with the actual voltage being unregulated, and either a jump in the current set value is initiated which would bring the device out of CC or when the load is suddenly cut from the power supply by an external means. Peak and duration of the overshooting aren't exactly defined, but as rule of thumb it shouldn't exceed a peak of 1-2% of the rated voltage (on top of the voltage setting) while the duration mainly depends on the charging state of the capacities on the DC output and also the capacity value.

3.2.3 Power regulation / constant power / power limiting

Power regulation, also known as power limiting or constant power (CP), keeps the DC output power of a power supply constant if the current flowing to the load in relation to the output voltage and the resistance of load reaches the adjusted value according to $P = U * I$ resp. $P = U^2 / R$. The power limiting then regulates the output current according to $I = \text{sqr}(P / R)$, where R is the load's true resistance.

Power limiting operates according to the auto-range principle such that at lower output voltages higher current flows and vice versa in order to maintain constant power within the range P_N (see diagram to the right).

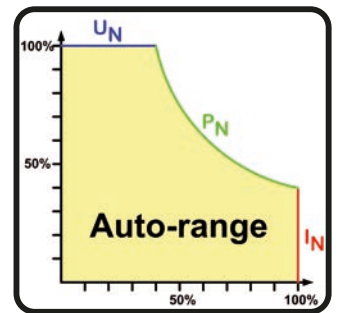

While the DC output is switched on and constant power mode is active, then the condition "CP mode active" will be shown on the graphic display by the abbreviation **CP**, as well stored as status which can also be read as a status message via digital interface.

3.2.3.1 Power derating

Primarily, the models in this series are designed for 400 V AC supply, but can also operate on a three-phase supply of 208 V (USA, Japan). In order to limit the AC current when running on this low input voltage, they switch to a derating mode which reduces the available DC power to 18 kW. The switchover is determined once when the device is powered and depends on the currently present AC supply voltage. It means that it cannot switch back and forth between derated and underated mode during operation. The full power is thus only available with AC voltages from 380 V or higher. Once derated, the device would show a permanent information in the display and all values related to the power are reduced in their adjustment range. This also applies to master-slave operation of several units.

3.2.4 Internal resistance regulation

Internal resistance control (short: CR) of power supplies is the simulation of a virtual internal resistor which is in series to the load. According to Ohm's law, this resistance causes a voltage drop, which will result in a difference between the adjusted output voltage and the actual output voltage. This will also work in CC or CP mode whereas the actual output voltage will differ even more from the adjusted voltage, because both modes limit the output voltage additionally. CR mode is actually running in CV, but will be indicated as CR on display once the adjusted resistance value is reached.

The adjustable resistance range of a particular model is given in the technical specifications. The voltage regulation in dependency of the resistance set value and the output current is done by calculation in a fast ARM controller, being only a little slower than other controllers inside the control circuit. Clarification:

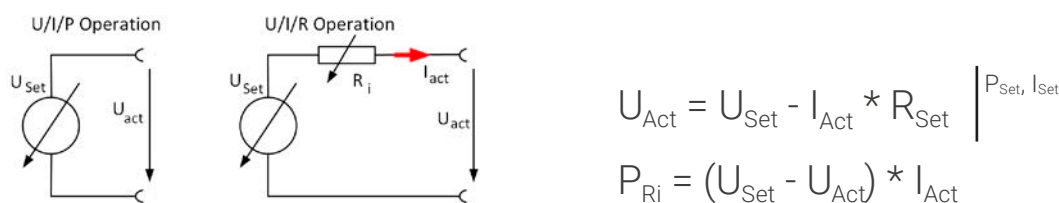

3.3 Alarm conditions



This section only gives an overview about device alarms. What to do in case your device indicates an alarm condition is described in section "3.6. Device alarm handling".

As a basic principle, all alarm conditions are signaled optically (text + message in the display), acoustically (if activated) and as a readable status and alarm counter via the digital interface. In addition, the alarms OT and OVP are reported as signals on the analogue interface. For later acquisition, an alarm counter can be read from the display or via digital interface.

3.3.1 Power Fail

Power Fail (PF) indicates an alarm condition which may have various causes:

- AC input voltage too low (mains undervoltage, mains failure)
- Defect in the input circuit (PFC)

As soon as a power fail occurs, the device will stop to supply or sink power and switch off the DC output. In case the power fail was an undervoltage and is gone later on, the device can continue to work as before, but this depends on a parameter in the settings menu called **DC output -> State after PF alarm**. The default setting would keep the DC output switched off, but leave the alarm in the display for notification.



Powering the device down (power switch) can't be distinguished from a supply blackout and thus the device will signalize a PF alarm every time it's switched off. This can be ignored.

3.3.2 Overtemperature

An overtemperature alarm (OT) can occur from an excess temperature inside the device and temporarily causes it to switch of the power stage(s). This is usually due to the ambient temperature exceeding the specified operating temperature range of the device. After cooling down, the device can automatically switch the DC terminal back on, depending on the setting of parameter **DC output -> State after OT alarm**. Also see section 3.4.3.1 for more information. The alarm will remain in the display as notification and can be cleared anytime.

3.3.3 Overvoltage protection

An overvoltage alarm (OVP) will switch off the DC output and can occur if:

- the power supply itself, as a voltage source, generates an output voltage higher than set for the overvoltage alarm threshold (OVP, 0...110% U_{Nom}) or the connected load somehow returns voltage higher than this threshold
- the OVP threshold has been adjusted too close above the output voltage. If the device is in CC mode and if it then experiences a negative load step, it will make the voltage rise quickly, resulting in a voltage overshoot for a short moment which can already trigger the OVP

This function serves to warn the user of the power supply acoustically or optically that the device probably has generated an excessive voltage which could damage the connected load application.



- The device isn't fitted with protection from external overvoltage
- The changeover from operation modes CC -> CV can generate voltage overshoots

3.3.4 Overcurrent protection

An overcurrent alarm (OCP) will switch off the DC output and can occur if:

- the output current in the DC output reaches the adjusted OCP limit.

This function serves to protect the connected load application so that this isn't overloaded and possibly damaged due to an excessive current.

3.3.5 Overpower protection

An overpower alarm (OPP) will switch off the DC output and can occur if:

- the product of the output voltage and output current in the DC output reaches the adjusted OPP limit.

This function serves to protect the connected load application so that this isn't overloaded and possibly damaged due to an excessive power consumption.

3.3.6 Safety OVP

This extra feature is only built into the **60 V model** of this series. Similar to the regular overvoltage protection (OVP, see 3.3.3), the Safety OVP is supposed to protect the application or people according to SELV. The alarm shall prevent the device from providing an output voltage higher than 60 V. However, it could also be triggered by an external source providing an excess voltage to the DC output of the device.

A safety OVP alarm can occur if

- the voltage on the DC of the device reaches the rigid threshold of 60.6 V.
- an external voltage of higher than 60.6 V is brought onto the device.

If the voltage on the DC output exceeds that level for any reason, the DC output will be switched off and alarm **Safety OVP** will be indicated in the display. This alarm can't be acknowledged the usual way. It requires to power-cycle the unit.



During normal operation of the power supply, this alarm should not trigger. There are, however, situations which can trigger the alarm, like when working with voltages close to the threshold of 60.6 V or voltage spikes when leaving CC mode when the current was 0 A before.



When remote sensing is used, i. e. the rear input "Sense" is connected, the true output voltage is higher than the adjusted value so the Safety OVP could already trigger at voltage settings lower than 60 V.

3.3.7 Share bus fail

A Share bus fail alarm (short: SF) will switch off the DC power stage and can occur if:

- the Share bus connectors of at least two units are already wired while at least one unit isn't yet configured for master-slave
- a short-circuit on the Share bus has occurred, for example due to a damaged BNC cable.

This function serves to prevent sending irregular control signals to the slave units via the Share bus or to cause them to react differently. This alarm has to be acknowledged after the cause has been removed. Should the device neither be master nor slave, the Share bus cable should be removed for unimpeded operation.

3.4 Manual operation

3.4.1 Switching on the device

The device should, as far as possible, always be switched on by putting the rotary switch on the front of the device to position 1. Alternatively this can be done using an external cutout (contactor, circuit breaker) of suitable current capacity.

After switching on, the display will first show some device related information (model, firmware versions etc.) and then a language selection screen for 3 seconds. A few seconds later it will show the main screen.

In the **Settings** menu (also see section "3.4.3. Configuration via the menu") in the group **DC output** is an option **State after power ON** in which the user can determine the condition of the DC output after power-up. Factory setting here is **Off**, meaning that the DC output will always be switched off after power-up. **Restore** means that the last condition will be restored, either on or off. All set values are always saved and restored.



For the time of the start phase the analog interface can signal undefined statuses on its digital outputs. This must be ignored until the device has finished booting and is ready to work.



While manually operated and while also being connected to any remote control equipment via any of the interfaces, the device could be taken over into remote control anytime without warning or request for confirmation. It's thus recommended to block remote control by activating the 'Local' mode for the duration of manual operation.

3.4.2 Switching the device off

The device is switched off by putting the power switch on the front in position 0. Doing so will cause two things: a) the immediate storage of the last condition of the DC output and the most recent set values and b) the occurrence of a PF alarm (power fail) which can be ignored. The DC output is also immediately switched off and after a certain stopping time (up to 30 seconds) the display and the fans will go off and then the device is completely powered off.



The power switch on the front cuts the device physically from the AC grid when in position 0. It thus qualifies as a separator.

3.4.3 Configuration via the menu

The settings menu is meant for the configuration of all operating parameters which are not constantly required. The menu is accessed by finger touch on the **Menu** touch area, but only while the DC output is switched off. See figure to the right.

While the DC output is switched on the settings menu will not be shown, but some status information.

Menu navigation is also done by finger touch. Inside menus, all values are adjusted using the numeric pad that pops up when tapping a value.

Many settings are self-explanatory, others are not. Those will be explained on the pages following.

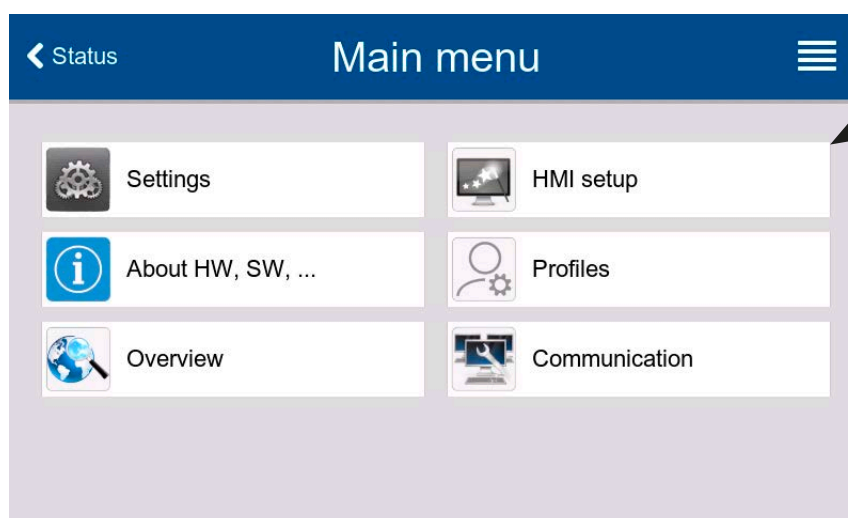

3.4.3.1 Sub menu “Settings”

Group	Parameters & description
Presets	U, I, P, R
	Presetting of all set values via on-screen numeric pad.
Protection	OVP, OCP, OPP
	Adjust the thresholds of the protections
Limits	U-max, U-min etc.
	Define the adjustment limits (find more information in “3.4.4. Adjustment limits”)
General	Allow remote control
	If remote control is allowed, the device cannot be controlled remotely over either the digital or analog interfaces. This situation will be shown as “Local” in the status area on the main display. Also see section 1.9.6.1.
	R mode
	Activates or deactivates the internal resistance control. If activated, the resistance set value and actual will be shown the main screen. For details refer to “3.2.4. Internal resistance regulation” and “3.4.6. Manual adjustment of set values”
	Voltage controller speed
	(Switching the speed only works if the device has already been delivered with firmware KE 3.02 or higher) This switch can be used to select the internal voltage controller speed which, as a result, impacts the voltage settling time. Also see “3.2.1.1. Voltage regulation peaks”. <ul style="list-style-type: none"> • Slow = the voltage controller will be a little slower, the peaks will be lower, but wider • Normal = the voltage controller is on standard speed (Default) • Fast = the voltage controller will be a little faster, the peaks will be higher but narrower
SEMI F47	Activates or deactivates a feature called SEMI F47 which is related to the equally named standard. See “3.10.3. SEMI F47” for more information.
Analog interface	Range
	Selects the voltage range for the analog set values, actual values and reference voltage output. <ul style="list-style-type: none"> • 0...5 V = Range is 0...100% for set /actual values, reference voltage will be 5 V • 0...10 V = Range is 0...100% for set /actual values, reference voltage will be 10 V Also see “3.5.4. Remote control via the analog interface”
	REM-SB Level
	Selects how the input pin REM-SB of the analog interface shall be working regarding levels (see “3.5.4.3. Analog interface specification”) and logic: <ul style="list-style-type: none"> • Normal = Levels and function as described in the table in 3.5.4.3 • Inverted = Levels and function will be inverted Also see “3.5.4.7. Application examples”.

Group	Parameters & description
Analog interface	REM-SB Action
	Selects how the input pin REM-SB of the analog interface shall operate regarding the DC output condition <u>outside</u> of analog remote control: <ul style="list-style-type: none"> • DC Off = the pin can only switch the DC power stage off • DC On/Off = the pin can switch the DC power stage off and on again, if it has been switched on before from a different control location
	Pin 6
	Pin 6 of the analog interface (see section 3.5.4.3) is by default assigned to signal both device alarms OT and PF. This parameter allows to also enable signaling only one of both (3 possible combinations): <ul style="list-style-type: none"> • Alarm OT = Pin 6 signals only alarm OT • Alarm PF = Pin 6 signals only alarm PF • Alarm PF + OT = Default, pin 6 signals either PF or OT
	Pin 14
Pin 14 of the analog interface (see section 3.5.4.3) is by default assigned to only signal the device alarm OVP. This parameter allows to also enable signaling the device alarms OCP and OPP in 7 possible combinations: <ul style="list-style-type: none"> • Alarm OVP = Pin 14 signals only OVP • Alarm OCP = Pin 14 signals only OCP • Alarm OPP = Pin 14 signals only OPP • Alarm OVP+OCP = Pin 14 signals OVP or OCP • Alarm OVP+OPP = Pin 14 signals OVP or OPP • Alarm OCP+OPP = Pin 14 signals OCP or OPP • Alarm OVP+OCP+OPP = Pin 14 signals any of the three alarms 	
Pin 15	
Pin 15 of the analog interface (see section 3.5.4.3) is by default assigned to signal the regulation mode CV. Alternatively, it allows to signal the DC output status: <ul style="list-style-type: none"> • Regulation mode = Signals the CV regulation mode • DC status = Signals the DC output status 	
DC output	State after power ON
	Determines the condition of the DC output after power-up. <ul style="list-style-type: none"> • Off = DC output is always off after switching on the device. • Restore = Default, DC output state will be restored from last switch-off. <div data-bbox="368 1507 1460 1641" style="border: 1px solid black; padding: 5px; margin-top: 10px;">  <p>The factory default of this setting, also after a device reset, is "Off". Setting this to "Restore" solely lies within the responsibility of the operator, as the device could automatically start to supply voltage after boot-up, depending on the restored state of the DC terminal. Be careful!</p> </div>
	State after PF alarm
	Determines the condition of the DC output after a power fail (PF) alarm: <ul style="list-style-type: none"> • Off = Default, DC output remains off • Auto = DC output will switch on again after the PF alarm cause is gone, if it has been switched on before the alarm occurred
State after remote	
Determines the condition of the DC output after leaving remote control either manually or by command: <ul style="list-style-type: none"> • Off = Default, DC output will always be off after leaving remote control • Auto = DC output will keep the last state 	

Group	Parameters & description
DC output	State after OT alarm Determines the condition of the DC output after an overtemperature (OT) alarm, once the device has cooled down: <ul style="list-style-type: none"> • Off = DC output will remain off • Auto = Default, the device will automatically restore the situation before the OT alarm, which usually means the DC output to be on
	Master-slave Mode Selecting Master or Slave enables the master-slave mode (MS) and defines the position for the unit in the MS system. For details see section "3.10.1. Parallel operation in master-slave (MS)". Termination resistor Activates or deactivates the so-called bus termination of the digital master-slave bus via a switchable resistor. Termination should be activation if required, usually when problems with the master-slave bus operation occur. Bias resistors Additionally to the regular termination resistor (TERM) this activates two bias resistor, if required, to help stabilize the bus further. Tap on the information symbol for a graphical depiction. Backlight off after 60 s If activated, it will switch off the display's backlight after 60 seconds of inactivity. This settings is primarily intended for slave units where the display isn't supposed to be permanently on. It's identical to the setting in menu HMI setup . Initialize system Tapping this touch area will repeat the initialization of the master-slave system in case the detection of all slave units by the master was unsuccessful, so the system would have less total power than expected, or has to be repeated manually in case the master unit couldn't detect a missing slave or one slave has failed.
USB logging	Log file separator format Defines the format of CSV files generated from logging files (also see 1.9.6.5 and 3.4.8). This setting also affects other features where a CSV file can be loaded or saved. <ul style="list-style-type: none"> • US = Comma as column separator (US standard for CSV files) • Default = Semicolon as column separator (german/european standard for CSV files)
	Logging with units (V,A,W) CSV files generated from USB logging by default add physical units to values. This can be deactivated here.
	USB logging Activates/deactivates logging to USB stick. For more information refer to "3.4.8. Recording to USB stick (logging)".
	Logging interval Defines the time between two records in the log file. Selection: 500 ms, 1 s, 2 s, 5 s
	Start/stop Defines how the USB logging is started and stopped. <ul style="list-style-type: none"> • Manual = Logging only starts and stops upon user interaction on the HMI, by accessing touch button  in the quick menu. • At DC on/off = Logging starts and stops with every change of state on the DC output, no matter if caused by the user, software or a device alarm. Attention: Every next start will create a new log file.

Group	Parameters & description
Reset / Restart	Reset device to defaults
	This touch area will initiate a reset of all settings (HMI, profile etc.) to factory default.
	Restart
	Triggers a warm start

3.4.3.2 Sub menu "Profiles"

See "3.9. Loading and saving user profiles".

3.4.3.3 Sub menu "Overview"

This menu page displays an overview of the set values (U, I, P or U, I, P, R), device alarm thresholds, adjustment limits, as well as an alarm history which lists the number of device alarms that occurred since the device has been powered.

3.4.3.4 Sub menu "About HW, SW..."

This menu page displays an overview of device relevant data such as serial number, article number etc.

3.4.3.5 Sub menu "Communication"

This sub menu offers settings for digital communication via the built-in interfaces USB and Ethernet and also for the optional interface modules of IF-AB series.

There is furthermore an adjustable communication timeout for USB or RS232, to make it possible to successfully transfer fragmented messages (data packets) using higher values. In group **Protocols** you can disable one of the two supported communication protocols, ModBus and SCPI. This can help to avoid mixing both protocols and to receive unreadable messages, for example when expecting an SCPI response and getting a ModBus response instead.

The USB itself doesn't require any settings. The device will have following default Ethernet port related settings which are listed in group **Ethernet (internal)**:

IF	Settings	Description
Ethernet (internal)	DHCP	The IF allows a DHCP server to allocate an IP address, a subnet mask and a gateway. If no DHCP server is in the network then network parameters will be set as defined below.
	IP address	Manually allocate an IP address.
	Subnet mask	Manually allocate a subnet mask.
	Gateway	Manually allocate a gateway address, if required.
	DNS address	Manually allocate addresses of a Domain Name Server (DNS), if required.
	Port	Select port in the range 0...65535. Default port: 5025 Reserved ports: 502 (ModBus TCP), 537
	Host name	User definable host name
	Domain	User definable domain

Settings for the optional interface modules (IF-AB-xxx)

IF	Settings	Description
CANopen	Baud Rate	CAN bus baud rate selection that is used by the CANopen interface. Auto = Automatic detection LSS = Baud rate and node address are assigned by the bus master Fixed baud rates: 10 kbps, 20 kbps, 50 kbps, 100 kbps, 125 kbps, 250 kbps, 500 kbps, 800 kbps, 1Mbps
	Node Address	Selection of the CANopen node address in the range 1...127

IF	Settings	Description
Profibus	Node Address	Selection of the Profibus or node address of the device within range 1...125 via direct input
	Function Tag	String input box for a user-definable text which describes the Profibus slave function tag. Max. length: 32 characters
	Location Tag	String input box for a user-definable text which describes the Profibus slave location tag. Max. length: 22 characters
	Installation Date	String input box for a user-definable text which describes the Profibus slave installation date tag. Max. length: 40 characters
	Description	String input box for a user-definable text which describes the Profibus slave. Max. length: 54 characters
	Manufacturer ID	Registered manufacturer ID with the Profibus organization
	Ident number	Product identification number, same as in the GSD file

IF	Settings	Description
Slot Ethernet, ModBus-TCP (1 & 2 Port)	DHCP	The IF allows a DHCP server to allocate an IP address, a subnet mask and a gateway. If no DHCP server is in the network then network parameters will be set as defined below.
	IP address	This option is activated by default. An IP address can be manually allocated.
	Subnet mask	Here a subnet mask can be defined if the default subnet mask is not suitable.
	Gateway	Here a gateway address can be allocated if required..
	DNS address	Here the addresses of the first and second Domain Name Servers (DNS) can be defined, if needed.
	Port	Select port in the range 0...65535. Default port: 5025 Reserved ports: 502 (ModBus TCP), 537
	Host name	User definable host name (default: Client)
	Domain	User definable domain (default: Workgroup)
	Speed / Duplex Port 1	Manual selection of transmission speed (10MBit/100MBit) and duplex mode (full/half). It's recommended to use the Auto option and only revert to another option if Auto fails.
	Speed / Duplex Port 2	Different Ethernet port settings for 2-port modules are possible, as these include an Ethernet switch

IF	Settings	Description
Profinet/IO (1 & 2 Port)	Host name	Free choice of host name (default: Client)
	Domain name	Free choice of Domain (default: Workgroup)
	Function Tag	String input box for a user-definable text which describes the Profinet slave function tag. Max. length: 32 characters
	Location Tag	String input box for a user-definable text which describes the Profinet slave location tag. Max. length: 22 characters
	Installation Date	String input box for a user-definable text which describes the Profibus slave installation date tag. Max. length: 40 characters
	Description	String input box for a user-definable text which describes the Profibus slave. Max. length: 54 characters
	Station Name	String input box for a user-definable text which describes the Profinet station name. Max. length: 200 characters

IF	Settings	Description
CAN	Baud rate	Setup of the CAN bus speed or baud rate in typical value between 10 kbps and 1Mbps. Default: 500 kbps
	ID Format	Selection of the CAN ID format and range between Standard (11 Bit ID, 0h...7ffh) and Extended (29 Bit, 0h...1fffffffh)
	Termination	Activates or deactivates CAN bus termination with a built-in resistor. Default: off
	Data length	Determines the DLC (data length) of all messages sent from the device. Auto = length can vary between 3 and 8 bytes Always 8 Bytes = length is always 8, filled up with zeros
	Base ID	Setup of the CAN base ID (11 Bit or 29 Bit, hex format). Default: 0h
	Broadcast ID	Setup of the CAN broadcast ID (11 Bit or 29 Bit, hex format). Default: 7ffh
	Base ID Cyclic Read	Setup of the CAN base ID (11 Bit or 29 Bit, hex format) for cyclic read of several object groups. The device will automatically send object data to the IDs defined with this setting. For more information refer to the programming guide. Default: 100h
	Base ID Cyclic Send	Setup of the CAN base ID (11 Bit or 29 Bit, hex format) for cyclic send of set values along with status. For more information refer to the programming guide. Default: 200h
	Cyclic Read Time: Status	Activation/deactivation and time setting for the cyclic read of status from the adjusted Base ID Cyclic Read Range: 20...5000 ms. Default: 0 ms (deactivated)
	Cyclic Read Time: Set values	Activation/deactivation and time setting for the cyclic read of set values of U & I from the adjusted Base ID Cyclic Read + 2 . Range: 20...5000 ms. Default: 0 ms (deactivated)
	Cyclic Read Time: Limit values 1	Activation/deactivation and time setting for the cyclic read of adjustment limits of U & I from the adjusted Base ID Cyclic Read + 3 . Range: 20...5000 ms. Default: 0 ms (deactivated)
	Cyclic Read Time: Limit values 2	Activation/deactivation and time setting for the cyclic read of adjustment limits of P & R to the adjusted Base ID Cyclic Read + 4 . Range: 20...5000 ms. Default: 0 ms (deactivated)
	Cyclic Read Time: Actual values	Activation/deactivation and time setting for the cyclic read of actual values from the adjusted Base ID Cyclic Read + 1 Range: 20...5000 ms. Default: 0 ms (deactivated)
	Module firmware	CAN module firmware version

IF	Settings	Description
RS232	Baud rate	The baud rate is selectable, other serial settings can't be changed and are defined like this: 8 data bits, 1 stop bit, parity = none Baud rates: 2400Bd, 4800Bd, 9600Bd, 19200Bd, 38400Bd, 57600Bd, 115200Bd

Group	Parameters & description
Timeouts	TCP keep-alive
	Activates keep-alive network functionality for the Ethernet port, which is used to keep the socket connection open. As long as keep-alive is valid in the network, the device will disable the Ethernet timeout. Also see below at "Timeout ETH".
	Timeout USB/RS232
	Defines the max. time between two subsequent bytes or blocks of a transferred message. For more information about the timeout refer to the external programming documentation "Programming Guide ModBus & SCPI". Default value: 5 ms , Range: 5...65535
	Timeout ETH
	Defines a timeout after which the device would close the socket connection if there was no command communication between the controlling unit (PC, PLC etc.) and the device for the adjusted time. The timeout is ineffective as long as option TCP keep-alive is enabled for the particular interface and the keep-alive network service is running. A setting of 0 would deactivate the timeout permanently. Default value: 5 s , Range: 0 / 5...65535 (0 = timeout deactivated)
Protocols	Interface monitoring / Timeout Interface monitoring
	Activates/deactivates the interface monitoring (see section "3.5.3.3. Interface monitoring"). Default values: off, 5 s / Range: 5..65535
	Communication protocols
	Enables or disables SCPI or ModBus communication protocols for the device. The change is immediately effective. Only one of both can be disabled.
	ModBus specification compliance
	Allows to switch from Limited (default setting) to Full which makes the device send messages in ModBus RTU or ModBus TCP format which fully comply to the specification and are compatible to softwares available on the market. With Limited the device would still use the old, partially wrong message format (see programming guide for details).

3.4.3.6 Menu "HMI Setup"

These settings refer exclusively to the control panel (HMI).

Group	Parameters & description
Language	Selection of the display language (default: English)
Sound	Key sound
	Activates or deactivates sounds when touching a touch area in the display. It can usefully signal that the action has been accepted.
	Alarm sound
	Activates or deactivates the additional acoustic signal of an alarm. See also "3.6. Device alarm handling".
Clock	Internal clock and date setup
Backlight	Backlight off after 60s
	The choice here is whether the backlight remains permanently on (default) or if it should go off when no input via screen or rotary knob is done for 60 s. As soon as there is input, the backlight returns automatically. Furthermore, the backlight intensity can be adjusted here.
Lock	See "3.8. Locking the adjustment limits and user profiles" and "3.9. Loading and saving user profiles"

3.4.4 Adjustment limits



Adjustment limits are only effective on the related set values, no matter if using manual adjustment or remote control setting!



Default is that all set values (U, I, P, R) are adjustable from 0 to 102%.

The full range may be obstructive in some cases, especially for protection of applications against overvoltage. Therefore upper and lower limits for current (I) and voltage (U) can be set separately, which then limit the range of the adjustable set values.

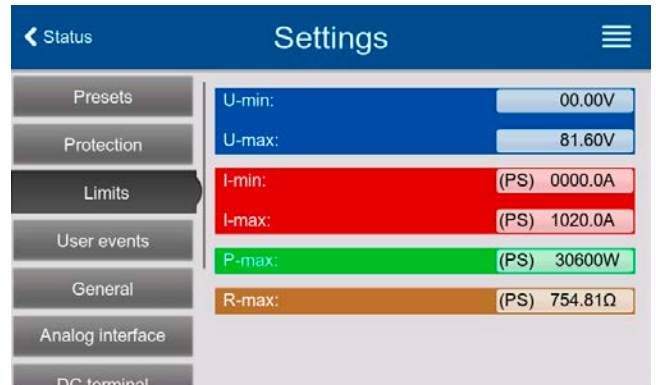
For power (P) and resistance (R) only upper value limits can be set.



► How to configure the adjustment limits

1. While the DC output is switched off, tap  on the main screen.
2. Tap on group **Limits** on the left side to open the list of limits. They are grouped and colored for distinction. Values are adjusted by tapping on them, in a window popping up with a numeric pad. Values further down in the list are accessed by swiping the list up.
3. Adjust the desired value and submit with .



The adjustment limits are coupled to the set values. It means, that the upper limit may not be set lower than the corresponding set value. Example: If you wish to set the limit for the power set value (P-max) to 6000 W while the currently adjusted power set value is 8000 W, then the set value first would have to be reduced to 6000 W or less, in order to set P-max down to 6000 W.

3.4.5 Changing the operating mode

In general, the manual operation of the device distinguishes between three operating modes: U/I, U/P and U/R. They are tied to set value input using the rotary knobs or the on-screen numeric pad. The current assignment can be switched anytime if you want to adjust a set value which is currently not assigned to any of the knobs.

► How to change the operating mode (two options)

1. Unless the device is in remote control or the panel is locked, you can switch the operation anytime. Tap on the depiction of the right-hand knob (see figure to the right) to change its assignment between I, P and R (if resistance mode had been enabled), which is then displayed accordingly.
2. Directly tap on the colored areas with the set values, like shown in the figure to the right. The physical unit next to the set value, when inverted, indicates the assignment to the knob.

Depending on the selection the right rotary knob will be assigned different setting values, the left knob is always assigned to the voltage.



In order to change the other values, like P or R while U/I is active, and without switching the assignment all the time, direct input can be used. See section 3.4.6. for details.

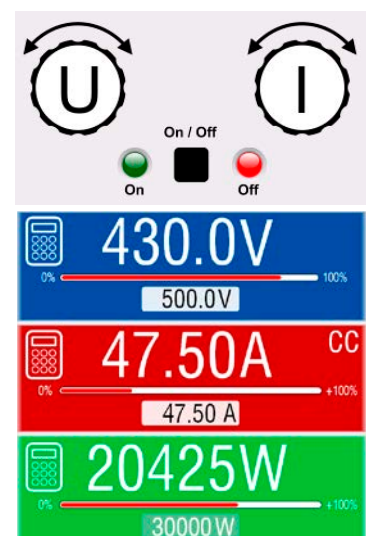

The actual operating mode, which is only indicated while the DC output is switched on, solely depends on the set values. For more information see section "3.2. Operating modes".

3.4.6 Manual adjustment of set values

The set values for voltage, current and power are the fundamental operating possibilities of a power supply and hence the two rotary knobs on the front of the device are always assigned to two of the values in manual operation.

As a fourth value there is the internal resistance R, for which the resistance mode (R mode) has to be activated first, for instance in the quick menu. Refer to "3.4.3. Configuration via the menu" and "3.2.4. Internal resistance regulation" for details.

Set values can be entered manually in two ways: via **rotary knob** or **direct input**. While the rotary knobs adjust values continuously, entering them via numeric pad can be used to change values in bigger steps.



Changing a value is immediately submitted, no matter if the DC output is switched on or off.



When adjusting set values, upper or lower limits may come into effect. See section "3.4.4. Adjustment limits". Once a limit is reached, the display will show a note like "Limit: U-max" etc. for 1.5 seconds next to the adjusted value.

► How to adjust set values U, I, P or R with the rotary knobs

1. First check if the value you want to change is already assigned to one of the rotary knobs. The main screen displays the assignment as depicted in the figure to the right.
2. If, as shown in the example, the assignment is voltage (U, left) and power (P, right), and it's required to set the current, then the assignments can be changed by tapping this touch area. A set of selection fields then appears.

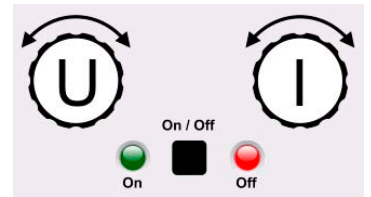

3. After successful selection, the desired value can be set within the defined limits. Selecting a digit is done by pushing the rotary knob which shifts the cursor from right to left (selected digit will be underlined):

47.50A → 47.50A → 47.50A

► How to adjust values via direct input:

1. In the main screen, depending on the rotary knob assignment, values can be set for voltage (U), current (I), power (P) or resistance (R) via direct input by tapping on the set/actual value display areas, e.g in the uppermost area of voltage.
2. Enter the required value using the ten-key pad. Similar to a pocket calculator the key **C** clears the input.
3. Decimal values are set by tapping the point key. For example, 54.3 V is entered with **5** **4** **.** **3** and **Enter**.
4. The display then switches back to the main page and the set values take effect.

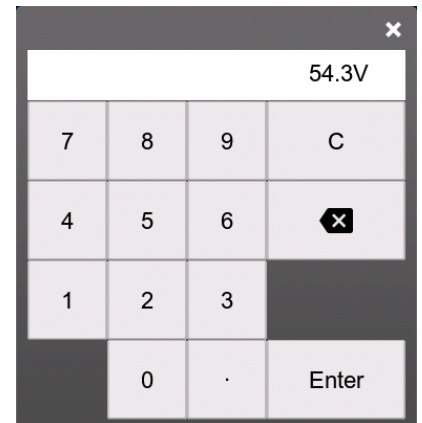

When entering a value which would exceed the upper/lower adjustment limit it would be rejected with an appropriate message.

3.4.7 Switching the DC output on or off

The DC output of the device can be manually or remotely switched on and off.



Switching the DC output on during manual operation or digital remote control can be disabled by pin REM-SB of the built-in analog interface. For more information refer to 3.4.3.1 and example a) in 3.5.4.7.

► How to manually switch the DC output on or off

1. As long as the control panel is not completely locked press the button **On/Off**. Otherwise you are asked to disable the HMI lock. In case the HMI lock is connected to a PIN, you are asked to enter the PIN first.
2. With the possible HMI lock removed, button **On/Off** toggles the DC output state, as long as this is not restricted by an alarm or the device being in remote control.

► How to remotely switch the DC output on or off via the analog interface

1. See section "3.5.4. Remote control via the analog interface".

► How to remotely switch the DC output on or off via the digital interface

1. See the external documentation "Programming Guide ModBus & SCPI" if you are using custom software, or refer to the external documentation from LabView VIs or other software provided by the manufacturer.

3.4.8 Recording to USB stick (logging)

Device data can be recorded to USB stick (USB 3.0 is supported, but not all memory sizes) anytime. For specifications of the USB stick and the generated log files refer to section "1.9.6.5. USB port (front side)".

The logging stores files of CSV format on the stick where the layout of the log data is the same as when logging via PC with software EA Power Control. The advantage of USB logging over PC logging is the mobility and that no PC is required. The logging feature just has to be activated and configured in the Settings.

3.4.8.1 Configuration



Also see section 3.4.3.5. After USB logging has been enabled and the parameters **Logging interval** and **Start/Stop** have been set, logging can be started anytime from within the Settings menu or when switching the DC output on, all depending on the selected start/stop mode.



Furthermore see section 3.4.3.1. There are additional settings for the CSV file itself as generated by the USB logging features. You can switch the column separator format between german/european standard (**Default**) or US american standard (**US**). The other option is used to deactivate the physical unit that is added by default to every set/actual value in the log file. Deactivating this option simplifies the CSV file processing in MS Excel or similar tools.

3.4.8.2 Handling (start/stop)

With setting **Start/stop** to **At DC on/off** logging will start each time the DC output of the device is switched on, no matter if manually with the front button **On/Off** or remotely via analog or digital interface. With setting **Manual** it's different. Logging is then started and stopped only in the quick menu (see figure to the right).



Button  starts logging manually and changed to , which is for manual stop.

Soon after logging has been started, the symbol  indicates the ongoing logging action. In case there is an error while logging, such as the USB stick is full or removed, it will be indicated by another symbol . After every manual stop or switching the DC output off the logging is stopped and the log file closed.

3.4.8.3 Log file format

Type: text file in german/european or US american CSV format (depending on the selected setting)

Layout (default german format shown):

	A	B	C	D	E	F	G	H	I	J	K	L	M
1	U set	U actual	I set	I actual	P set	P actual	R set	R actual	R mode	Output/Input	Device mode	Error	Time
2	2,00V	11,92V	1,20A	1,20A	7344W	15W	N/A	N/A	OFF	ON	CC	NONE	00:00:00,942
3	2,00V	11,90V	1,20A	1,20A	7344W	15W	N/A	N/A	OFF	ON	CC	NONE	00:00:01,942
4	2,00V	11,89V	1,20A	1,20A	7344W	15W	N/A	N/A	OFF	ON	CC	NONE	00:00:02,942
5	2,00V	11,87V	1,20A	1,20A	7344W	15W	N/A	N/A	OFF	ON	CC	NONE	00:00:03,942

Legend:

U set / I set / P set / R set: Set values U, I, P and R

U actual / I actual / P actual / R actual: Actual values

R mode: Resistance mode activated/deactivated (also called 'UIR mode')

Output/Input: State of the DC output

Device mode: Actual regulation mode (also see "3.2. Operating modes")

Error: Device alarms

Time: Elapsed time since logging start

Important to know:

- R set and R actual are only recorded if UIR mode is active (refer to section 3.4.5)
- Unlike the logging on PC, every log start here creates a new log file with a counter in the file name, starting generally with 1, but minding existing files

3.4.8.4 Special notes and limitations

- Max. log file size (due to FAT32 formatting): 4 GB
- Max. number of log files in folder HMI_FILES: 1024
- With setting **Start/stop** being **At DC on/off**, the logging will also stop on alarms, because they switch off the DC output
- With setting **Start/stop** being **Manual**, the device will continue to log even on occurring alarms, so this mode can be used to determine the period of temporary alarms like OT or PF

3.4.9 The quick menu

The device offers a quick menu which allows for the quick access to often used features and modes being switched on or off in the **Settings** menu. It can be opened by swiping up from the bottom screen edge or tapping the bar:

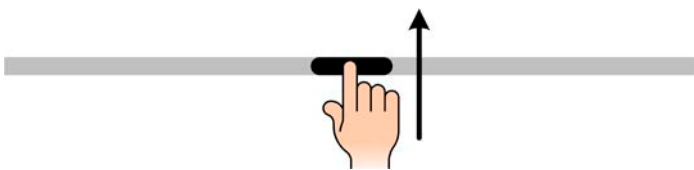

Overview:



Tapping a button activates or deactivates a feature. Buttons with black on white indicate an activated feature:

Symbol	Belongs to	Meaning
	USB logging	USB logging is running (the symbols is only available when USB logging has been activated in menu Settings)
	Master-slave	Master-slave activated, device is master
	Master-slave	Master-slave activated, device is slave
	Master-slave	Master-slave deactivated
	Resistance mode	R mode = on
	HMI	Alarm sound = on
	HMI	Key sound = on
	HMI	Opens the graph screen
	Operation modes	Switches voltage controller speed between Slow , Normal (default) and Fast (see 3.2.1.1)
	HMI	Adjust backlight intensity
	HMI	Opens the main menu

3.4.10 The graph

From HMI firmware version 2.02 the devices feature a manually callable, HMI operated visual depiction of the temporal run of the actual values of voltage, current and power, called the graph. It can't record data. For data recording in the background there is the USB logging option (see 3.4.8).

In normal operation the graph can be called anytime via the quick menu. Once called, it completely fills the screen.



Limited control options available while the graph is up! For safety reasons it's, however, possible to switch off the DC output anytime.

Overview:

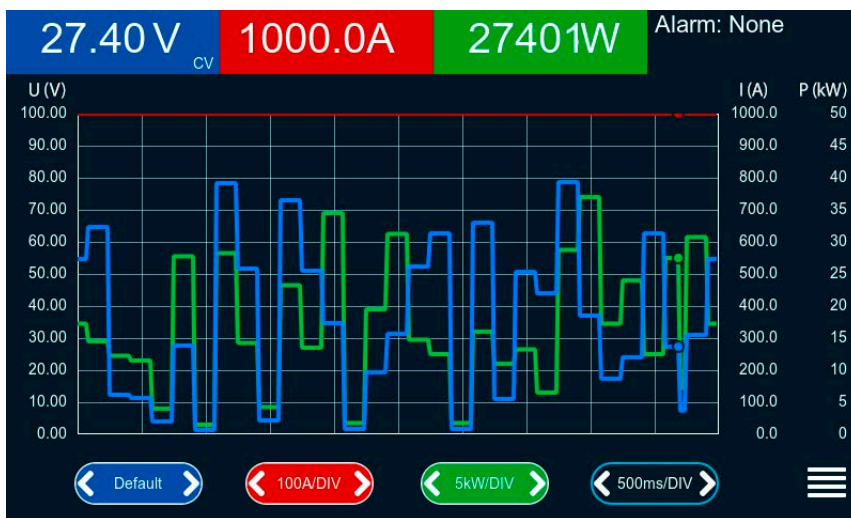

Controls:

- Tapping the **middle** of the three red/green/blue touch areas deactivates/activate the corresponding plot
- Tapping the **sides** (arrows left/right) of the red/green/blue touch areas increases/decreases the vertical scaling
- Tapping the **sides** (arrows left/right) of the black touch area increases/decreases the horizontal scaling
- Swiping on the three scales (Y axis) moves them up or down
- Tapping the menu touch area () exits the graph screen anytime

3.5 Remote control

3.5.1 General

Remote control is possible via one of the built-in interfaces (analog, USB, Ethernet) or via one of the optional interface modules. Important here is that only the analog or one digital interface can be in control. One of the digital ones is the master-slave bus.

It means that if an attempt was made to switch to remote control via the digital interface whilst analog remote control is active (pin REMOTE = LOW) the device would report an error via the digital interface. In the opposite direction, a switch-over via pin REMOTE would be ignored. However, status monitoring and reading of values are always possible.

3.5.2 Control locations

Control locations are those locations from where the device can be controlled. Essentially there are two: at the device (manual operation) and external (remote control). The following locations are defined:

Displayed location	Description
Remote: None	If neither of the other locations is displayed then manual control is active and access from the analog and digital interfaces is allowed.
Remote: <interface_name>	Remote control via any interface is active
Local	Remote control is locked, only manual operation is allowed.

Remote control may be allowed or inhibited using the setting **Allow remote control** (see "3.4.3.1. Sub menu "Settings"). In inhibited condition the status Local will be displayed top right. Activating the inhibit can be useful if the device is remotely controlled by software or some electronic device, but it's required to make adjustments at the device or deal with emergency.

Activating condition **Local** causes the following:

- If remote control via the digital interface is active (e. g. **Remote: USB**), then it's immediately terminated and in order to continue remote control once **Local** is no longer active, it has to be reactivated at the PC
- If remote control via the analog interface is active (**Remote: Analog**), then it's temporarily interrupted until remote control is allowed again by deactivating **Local**, because pin REMOTE continues to signal "remote control = on", unless this has been changed during the **Local** period.

3.5.3 Remote control via a digital interface

3.5.3.1 Selecting an interface

All models of series PS 10000 support, in addition to the built-in USB and Ethernet ports, the following optionally available interface modules:

Short ID	Type	Ports	Description*
IF-AB-CANO	CANopen	1	CANopen slave with generic EDS
IF-AB-RS232	RS232	1	Standard RS232, serial
IF-AB-PBUS	Profibus	1	Profibus DP-V1 slave
IF-AB-PNET1P	ProfiNet	1	Profinet DP-V1 slave
IF-AB-PNET2P	ProfiNet	2	Profinet DP-V1 slave, with switch
IF-AB-CAN	CAN	1	CAN 2.0 A / 2.0 B
IF-AB-ECT	EtherCAT	2	Basic EtherCAT slave with CANopen over Ethernet (CoE)
IF-AB-MBUS	ModBus TCP	1	ModBus TCP protocol via Ethernet
IF-AB-MBUS2P	ModBus TCP	2	ModBus TCP protocol via Ethernet

* For technical details of the various modules see the extra documentation "Programming Guide Modbus & SCPI"

3.5.3.2 Programming

Programming details for the interfaces, the communication protocols etc. are to be found in the documentation "Programming Guide ModBus & SCPI" which is supplied on the included USB stick or which is available as download from the manufacturer's website.

3.5.3.3 Interface monitoring

Interface monitoring is a configurable functionality introduced in firmwares KE 2.06 and HMI 2.08. Its goal is to monitor (or supervise) the communication line between the device and a superior control unit, such as PC or PLC, and to ensure that the device wouldn't continue working uncontrolled in case the communication line fails. A failing line can mean that it's either physically interrupted (damaged cable, bad contact, cable pulled) or the interface port inside the device hangs.

The monitoring is always only valid for one of the digital interfaces, the one being used for remote control. It thus means that the monitoring can become temporarily inactive when the device leaves remote control. It's furthermore based on a user-definable timeout which would run out if not at least one message is sent to the device within the given time frame. After every message, the timeout would start again and reset with the next message coming. In case it runs out, following reaction of the device is defined:

- Exit remote control
- In case the DC output is switched on, it either switches it off or leaves it on, as defined by the parameter **DC output -> State after remote** (see 3.4.3.1)

Notes for the operation:

- The timeout of the monitoring can be changed anytime via remote control; the new value would only be valid after the current timeout has elapsed
- The interface monitoring doesn't deactivate the Ethernet connection timeout (see 3.4.3.5), so these two timeouts can overlap

3.5.4 Remote control via the analog interface

3.5.4.1 General

The built-in, galvanically isolated, 15-pole analog interface (below referenced in short form as **AI**) is located on the rear side of the device and provides the following possibilities:

- Remote control of current, voltage, power and internal resistance
- Remote status monitoring (CC/CP, CV, DC output)
- Remote alarm monitoring (OT, OVP, OCP, OPP, PF)
- Remote monitoring of actual values
- Remote on/off switching of the DC output

Setting the set values of voltage, current and power via the analog interface must always be done concurrently. It means, that for example the voltage can't be given via the AI and current and power set by the rotary knobs, or vice versa. The internal resistance set value can additionally be adjusted.

The OVP set value and other alarm thresholds can't be set via the AI and therefore must be adapted to the given situation before the AI is taking over control. Analog set values can be supplied from an external voltage source or can be derived from the reference voltage on pin 3. As soon as remote control via the analog interface is activated, the set values on the display will be those supplied to the interface.

The AI can be operated in the common voltage ranges 0...5 V and 0...10 V, both representing 0...100% of the rated value. The selection of the voltage range can be done in the device setup. See section "3.4.3. Configuration via the menu" for details. The reference voltage sent out from pin 3 (VREF) will be adapted accordingly:

0-5 V: Reference voltage = 5 V, 0...5 V set value signal for VSEL, CSEL, PSEL and RSEL correspond to 0...100% nominal value, 0...100% actual values correspond to 0...5 V at the actual value outputs CMON and VMON.

0-10 V: Reference voltage = 10 V, 0...10 V set value signal for VSEL, CSEL, PSEL and RSEL correspond to 0...100% nominal values, 0...100% actual values correspond to 0...10 V at the actual value outputs CMON and VMON.

All set values are always additionally limited to the corresponding adjustment limits (U-max, I-max etc.), which would clip setting excess values for the DC output. Also see section "3.4.4. Adjustment limits".

Before you begin, please read these important notes about the use of the interface:



After powering the device and during the start phase the AI signals undefined statuses on the output pins. Those must be ignored until is ready to work.

- Analog remote control of the device must be activated by switching pin REMOTE (5) first. Only exception is pin REM-SB, which can be used independently
- Before the hardware is connected that will control the analog interface, it shall be checked that it can't provide voltage to the pins higher than specified (table in 3.5.4.3)
- Set value inputs, such as VSEL, CSEL, PSEL and RSEL, if R mode is activated, must not be left unconnected (i.e. floating) during analog remote control. In case any of the set values isn't used for adjustment, it can be tied to a defined level or connected to pin VREF (solder bridge or different)

3.5.4.2 Acknowledging device alarms

In case of a device alarm occurring during remote control via analog interface, the DC output will be switched off the same way as in manual control. The device would indicate an alarm (see 3.6) in the front display and, if activated, acoustically and also signal most of them on the analog interface. Which alarms are eventually signaled can be set up in the device configuration menu (see "3.4.3.1. Sub menu "Settings").

The alarms MSP, OVP, OCP and OPP have to be acknowledged (also see "3.6. Device alarm handling"). Acknowledgment is done with pin REM-SB switching the DC output off and on again, that's means a HIGH-LOW-HIGH edge (min. 50ms for LOW), given the default logical level is set for REM-SB.

The same is required for PF and OT in case the related settings **State after PF alarm** or **State after OT alarm** in settings menu group **DC output** are set to **Off**.

There is one **exception**: the SOVP (Safety OVP) alarm, which is only featured with the 60 V model of this series. It can't be acknowledged and requires to power-cycle the device. It can be monitored via the analog interface and would be indicated by the alarms PF and OVP being signaled at the same time, so it would require to select the alarm indication on pin 6 to at least signal PF and for pin 14 to signal OVP in any of the combinations.

3.5.4.3 Analog interface specification

Pin	Name	Type ⁽¹⁾	Description	Default levels	Electrical specifications
1	VSEL	AI	Set voltage value	0...10 V or. 0...5 V correspond to 0..100% of U_{Nom}	Accuracy 0-5 V range: < 0.4% ⁽⁵⁾ Accuracy 0-10 V range: < 0.2% ⁽⁵⁾
2	CSEL	AI	Set current value	0...10 V or. 0...5 V correspond to 0..100% of I_{Nom}	Input impedance R_i >40 k...100 k
3	VREF	AO	Reference voltage	10 V or 5 V	Tolerance < 0.2% at $I_{max} = +5$ mA Short-circuit-proof against AGND
4	DGND	POT	Digital ground		For control and status signals
5	REMOTE	DI	Switches between manual and remote control	Remote = LOW, $U_{Low} < 1$ V Manual = HIGH, $U_{High} > 4$ V Manual, if pin not wired	Voltage range = 0...30 V $I_{Max} = -1$ mA at 5 V U_{Low to HIGH typ. = 3 V Rec'd sender: Open collector against DGND
6	ALARMS 1	DO	Overheating or power fail alarm	Alarm = HIGH, $U_{High} > 4$ V No alarm = LOW, $U_{Low} < 1$ V	Quasi open collector with pull-up against V_{cc} ⁽²⁾ With 5 V on the pin max. flow +1 mA $I_{Max} = -10$ mA at $U_{CE} = 0,3$ V $U_{Max} = 30$ V Short-circuit-proof against DGND
7	RSEL	AI	Set internal resistance value	0...10 V or. 0...5 V correspond to 0..100% of R_{Max}	Accuracy 0-5 V range: < 0.4% ⁽⁵⁾ Accuracy 0-10 V range: < 0.2% ⁽⁵⁾
8	PSEL	AI	Set power value	0...10 V or. 0...5 V correspond to 0..100% of P_{Nom}	Input impedance R_i >40 k...100 k
9	VMON	AO	Actual voltage	0...10 V or. 0...5 V correspond to 0..100% of U_{Nom}	Accuracy 0-5 V range: < 0.4% ⁽⁵⁾ Accuracy 0-10 V range: < 0.2% ⁽⁵⁾
10	CMON	AO	Actual current	0...10 V or. 0...5 V correspond to 0..100% of I_{Nom}	at $I_{Max} = +2$ mA Short-circuit-proof against AGND
11	AGND	POT	Analog ground		For xSEL, xMON and VREF
12	R-ACTIVE	DI	R mode on / off	Off = LOW, $U_{Low} < 1$ V On = HIGH, $U_{High} > 4$ V On, if pin not wired	Voltage range = 0...30 V $I_{Max} = -1$ mA bei 5 V U_{Low to HIGH typ. = 3 V Rec'd sender: Open collector against DGND
13	REM-SB	DI	DC output OFF (DC output ON) (ACK alarms ⁽⁴⁾)	Off = LOW, $U_{Low} < 1$ V On = HIGH, $U_{High} > 4$ V On, if pin not wired	Voltage range = 0...30 V $I_{Max} = +1$ mA at 5 V Rec'd sender: Open collector against DGND
14	ALARMS 2	DO	Overvoltage alarm Overcurrent alarm Overpower alarm	Alarm = HIGH, $U_{High} > 4$ V No alarm = LOW, $U_{Low} < 1$ V	Quasi open collector with pull-up against V_{cc} ⁽²⁾ With 5 V on the pin max. flow +1 mA $I_{Max} = -10$ mA at $U_{CE} = 0,3$ V, $U_{Max} = 30$ V Short-circuit-proof against DGND
15	STATUS ⁽³⁾	DO	Constant voltage regulation active DC output	CV = LOW, $U_{Low} < 1$ V CC/CP/CR = HIGH, $U_{High} > 4$ V Off = LOW, $U_{Low} < 1$ V On = HIGH, $U_{High} > 4$ V	

(1) AI = Analog Input, AO = Analog Output, DI = Digital Input, DO = Digital Output, POT = Potential

(2) Internal V_{cc} approx. 10 V

(3) Only one of both signals possible, see section 3.4.3.1

(4) Only during remote control

(5) The error of an analog input/output adds to the general error of the related value on the DC output of the device

3.5.4.4 Resolution

The analog interface is internally sampled and processed by a digital microcontroller. This causes a limited resolution of analog steps. The resolution is the same for set values (VSEL etc.) and actual values (VMON/CMON) and is 26214 when working with the 10 V range. In the 5 V range this resolution halves. Due to tolerances, the truly achievable resolution can be slightly lower.

3.5.4.5 Overview of the Sub-D Socket

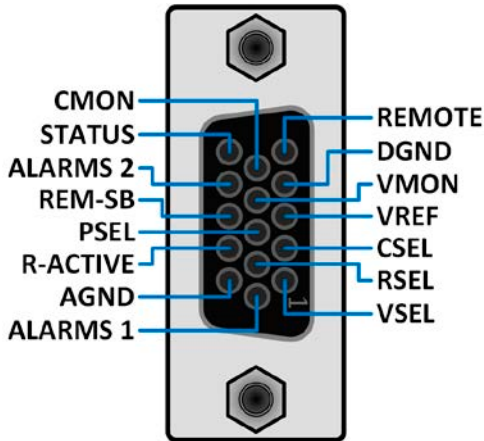

3.5.4.6 Simplified diagram of the pins

	<p>Digital Input (DI)</p> <p>The DI is internally pulled up and thus it requires to use a contact with low resistance (relay, switch, contactor etc.) in order to clearly pull the signal down to DGND.</p>		<p>Analog Input (AI)</p> <p>High resistance input (impedance >40 k...100 kΩ) for an operational amplifier circuit.</p>
	<p>Digital Output (DO)</p> <p>A quasi open collector, realized as high resistance pull-up against the internal supply. The design doesn't allow the pin to be loaded, but to switch signals by sinking current.</p>		<p>Analog Output (AO)</p> <p>Output from an operational amplifier circuit, low impedance. See specifications table above.</p>

3.5.4.7 Application examples

a) Switching the DC output with pin REM-SB

A digital output, e.g. from a PLC, may be unable to cleanly pull down the pin as it may not be of low enough resistance. Check the specification of the controlling application. Also see pin diagrams above.

In remote control, pin REM-SB is used to switch the DC output of the device on and off. This function is also available without remote control being active and can on the one hand block the DC output from being switched on in manual or digital remote control and on the other hand the pin can switch the DC output on or off, but not standalone. See below at "Remote control has not been activated".

REM-SB cannot serve as a safety stop switch to securely deactivate the DC output in case of emergency! For that an external emergency stop system is required.

It's recommended that a low resistance contact such as a switch, relay or transistor is used to switch the pin to ground (DGND).

Following situations can occur:

- Remote control has been activated**

During remote control via analog interface, only pin REM-SB determines the states of the DC output, according to the levels definitions in 3.5.4.3. The logical function and the default levels can be inverted by a parameter in the setup menu of the device. See 3.4.3.1.

If the pin is unconnected or the connected contact is open, the pin will be HIGH. With setting "Analog interface -> REM-SB level" being set to "Normal", it requests to switch the DC output on. So when activating remote control, the DC output will instantly switch on.

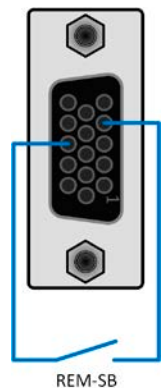

• **Remote control isn't active**

In this mode of operation pin REM-SB can serve as lock, preventing the DC output from being switched on by any means. This results in following possible situations:

DC output	+	Level on pin REM-SB	+	Parameter „REM-SB Level“	→ Behavior
is off	+	HIGH	+	Normal	→ The DC output isn't locked. It can be switched on by pushbutton "On/Off" (front panel) or via command from digital interface.
		LOW	+	Inverted	
	+	HIGH	+	Inverted	→ The DC output locked. It can't be switched on by pushbutton "On/Off" (front panel) or via command from digital interface. When trying to switch on, a pop-up in the display resp. an error message will be generated.
		LOW	+	Normal	

In case the DC output is already switched on, toggling the pin will switch the DC output off, similar to what it does in analog remote control:

DC output	+	Level on pin REM-SB	+	Parameter „REM-SB Level“	→ Behavior
is on	+	HIGH	+	Normal	→ The DC output remains on, nothing is locked. It can be switched on or off by pushbutton or digital command.
		LOW	+	Inverted	
	+	HIGH	+	Inverted	→ The DC output will be switched off and locked. Later it can be switched on again by toggling the pin. During lock, pushbutton or digital command can delete the request to switch on by pin.
		LOW	+	Normal	

b) Remote control of current and power

Requires remote control to be activated (Pin REMOTE = LOW)

The set values PSEL and CSEL are generated from, for example, the reference voltage VREF, using potentiometers for each. Hence the power supply can selectively work in current limiting or power limiting mode. According to the specification of max. 5 mA load for the VREF output, potentiometers of at least 10 kΩ must be used.

The voltage set value VSEL is directly connected to VREF and will thus be permanently 100%.

If the control voltage is fed in from an external source it's necessary to mind the input voltage range for set values (0...5 V or 0...10 V).



Use of the input voltage range 0...5 V for 0...100% set value halves the effective resolution.

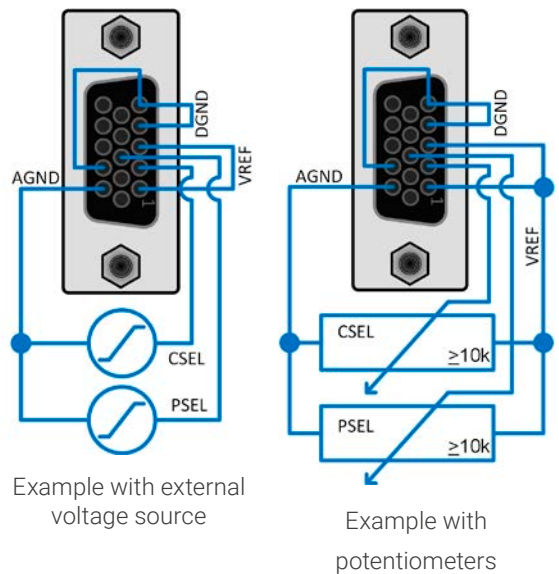

c) Reading actual values

The AI provides the actual values on the DC output as current and voltage monitor. These can be read using a standard multimeter or an analog input of a PLC etc.

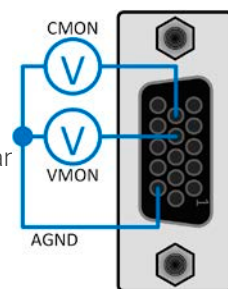

3.6 Device alarm handling

A device alarm incident will usually lead to DC output switch-off, the appearance of a pop-up in the middle of the display and, if activated, an acoustic signal to make the user aware. An alarm must always be acknowledged.

► **How to acknowledge an alarm in the display (during manual control)**

1. If the alarm is currently shown as pop-up, tap **Acknowledge**.
2. If the alarm has already been acknowledged, but is still displayed in the status area, then first tap the status area to display the pop-up and then **Acknowledge**.



In order to acknowledge an alarm during analog remote control see "3.5.4.2. Acknowledging device alarms". To acknowledge in digital remote control, refer to the external documentation "Programming guide ModBus & SCPI".

Some device alarms are configurable:

Short	Long	Description	Range	Indication
OVP	OverVoltage Protection	Triggers an alarm as soon as the DC output voltage reaches the OVP threshold. The DC output will be switched off.	0 V...1.1*U _{Nom}	Display, analog & digital interface
OCP	OverCurrent Protection	Triggers an alarm as soon as the DC output current reaches the OCP threshold. The DC output will be switched off.	0 A...1.1*I _{Nom}	
OPP	OverPower Protection	Triggers an alarm as soon as the DC output power reaches the OPP threshold. The DC output will be switched off.	0 W...1.1*P _{Nom}	

These device alarms can't be configured and are based on hardware:



Short	Long	Description	Indication
PF	Power Fail	AC supply over- or undervoltage. Triggers an alarm in case the AC supply is out of specification or when the device is cut from supply, for example when switching it off with the power switch. The DC terminal will be switched off. The condition of the DC terminal after a temporary PF alarm can be determined by the setting DC output -> State after PF alarm .  <i>Acknowledging a PF alarm during runtime can only occur approx. 15 seconds after the cause of the alarm has gone. Switching the DC output on again requires another approx. 5 seconds of waiting time.</i>	Display, analog & digital interface
OT	OverTemperature	Triggers an alarm if the internal temperature reaches a certain limit. The DC output will be switched off which could be only temporarily, depending on the setting DC output -> State after OT alarm (see 3.4.3.1).	Display, analog & digital interface
MSP	Master-Slave Protection	Triggers an alarm if the master unit loses contact to any slave unit. The DC output will be switched off. The alarm can be cleared by reinitializing the MS system or deactivating master-slave mode.	Display, digital interface
Safety OVP	Safety OverVoltage Protection	Only featured with the 60 V model: Triggers a special OVP alarm when the voltage on the DC output exceeds the rigid threshold of 101% rated voltage. The DC output will be switched off. For details refer to section 3.3.6	Display, analog & digital interfaces
SF	Share Bus Fail	Can occur in situations where the Share bus signal is damped too much due to wrong or damaged (short-circuit) BNC cables or simply when at least one of the Share bus connectors is wired to another device while the device reporting the isn't (yet) configured for master-slave operation. For details also see 3.3.7.	Display, digital interfaces

► How to configure the thresholds of the adjustable device alarms

1. While the DC output is switched off tap the touch area  on the main screen.
2. In the menu tap on group **Protection**. On the right-hand side of the screen it will list all device alarms with their adjustable thresholds. These are permanently compared to the actual values of voltage, current and power on the DC output.
3. Set the threshold for the protections relevant to your application if the default value of 110% is unsuitable.

The user also has the possibility of selecting whether an additional acoustic signal will be sounded if an alarm occurs.

► How to configure the alarm sound (also see “3.4.3. Configuration via the menu”)

1. Swipe with your finger up from the bottom edge of the screen or directly tap on the bottom bar:

2. The quick menu will open. Tap on  to activate the alarm sound, or on  to deactivate it.
3. Leave the quick menu.

3.7 Locking the control panel (HMI)

In order to avoid the accidental alteration of a value during manual operation the rotary knobs or the touchscreen can be locked so that no alteration of values will be accepted without prior unlocking.

► How to lock the HMI

1. In the main page, tap the lock symbol  (upper right corner).
2. The **Lock** screen will appear where you can select to lock the HMI completely or with the exception of the button **On/Off** by enabling **On/Off possible during HMI lock**. Additionally, you can decide to activate the additional **PIN for user interface lock**. The device would later request to enter this PIN every time you want to unlock the HMI.
3. Activate the lock with **Start**. The device will jump back to the main screen and dim it.

If an attempt is made to tap the screen or rotate a knob whilst the HMI is locked, a requester appears in the display asking if the lock should be disabled.

► How to unlock the HMI

1. Tap any area on the touchscreen or rotate any knob or press the button On/Off (only in full lock).

2. This request pop-up will appear:

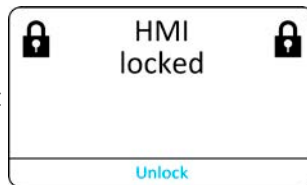

3. Unlock the HMI by tapping on **Unlock** within 5 seconds, otherwise the pop-up will disappear and the HMI remains locked. In case the additional PIN code lock has been activated in the **Lock** screen, another requester will pop up, asking you to enter the PIN before it finally unlocks the HMI.

3.8 Locking the adjustment limits and user profiles

In order to avoid the alteration of the adjustment limits (also see "3.4.4. Adjustment limits") by an unprivileged user, the screen with the adjustment limit settings (**Limits**) can be locked by a PIN code. This will lock group **Limits** in the **Settings** menu and menu **Profiles** until the lock is removed by entering the correct PIN or, in case it has been forgotten, by resetting the device to factory default.

► How to lock the Limits and Profiles

1. While the DC output is switched off, tap touch area  on the main screen. In case the HMI is locked, it has to be unlocked first, probably by entering the PIN. After this, menu page **Lock** will be entered.
2. In the switch next to **Lock limits and profiles with user PIN**.
3. Leave the **Settings** menu.



The same PIN as for the HMI lock is used here. It should be set before activating the Limits lock. See "3.7. Locking the control panel (HMI)"



Be careful to enable the lock if you are unsure what PIN is currently set. In doubt use ESC to exit the menu page. In menu page Lock you can define a different PIN, but not without entering the old one.

► How to unlock the Limits and Profiles

1. While the DC output is switched off, tap touch area  on the main screen.
2. In the menu tap on **HMI setup**, then on group **Lock**.
3. In the group tap on **Unlock limits and profiles**. You will be requested to enter the 4-digit PIN.
4. Deactivate the lock by entering the correct PIN.

3.9 Loading and saving user profiles

The menu Profiles serves to select between a default profile and up to 5 user profiles. A profile is a collection of all settings and set values. Upon delivery or after a factory reset all 6 profiles have the same settings and all set values are 0. Values adjusted on the main screen or anywhere else belong to a working profile which can be saved to one of the 5 user profiles. These user profiles or the default profile can then be switched. The default profile is read-only.

The purpose of a profile is to load a set of set values, settings limits and monitoring thresholds quickly without having to readjust these. As all HMI settings are saved in the profile, including language, a profile change can also be accompanied by a change in HMI language.

On calling up the menu page and selecting a profile the most important settings can be seen, but not changed.

► How to save the current values and settings as a user profile:

1. While the DC output is switched off, tap touch area on the main screen.
2. In the main menu tap on **Profiles**.
3. In the next screen (see example to the right) choose between user profiles 1-5, which will show the profile's stored settings for your verification.
4. Tap on **Save/Load** and save the settings into the user profile in the popping up requester (**Save profile?**) with **Save**.

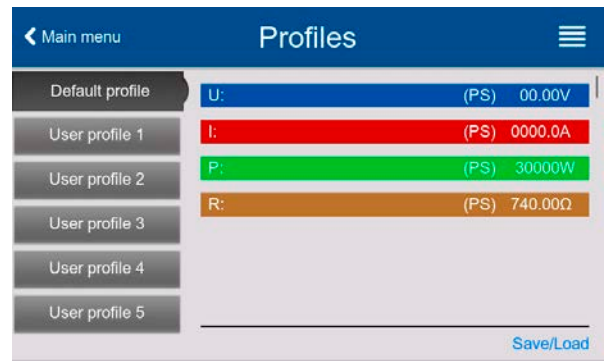

All user profiles also allow to just edit some settings or values stored in the profile. When doing so, the changes either need to be saved to the profile with Save changes or discarded with Cancel before the profile can be loaded.

Loading a user profile works the same way, but in the requester you would then tap **Load** under **Load profile?**. Alternatively, you may import the profile or export it as file to an USB stick with **USB Import/Export**.

3.10 Other applications

3.10.1 Parallel operation in master-slave (MS)

Multiple devices of same kind can be connected in parallel in order to create a system with higher total current and hence higher power. For parallel operation in master-slave mode the units are usually connected with their DC outputs, their Share bus and their master-slave bus, which is a digital bus that makes the system work as one big unit regarding adjusted values, actual values and status.

The Share bus is intended to balance the units dynamically in their voltage on the DC output, i.e. in CV mode, especially if the master unit runs the function generator, if featured. In order for this bus to work correctly, at least the DC minus poles of all units have to be connected, because DC minus is the reference for the Share bus.

Principle view (without load or source):

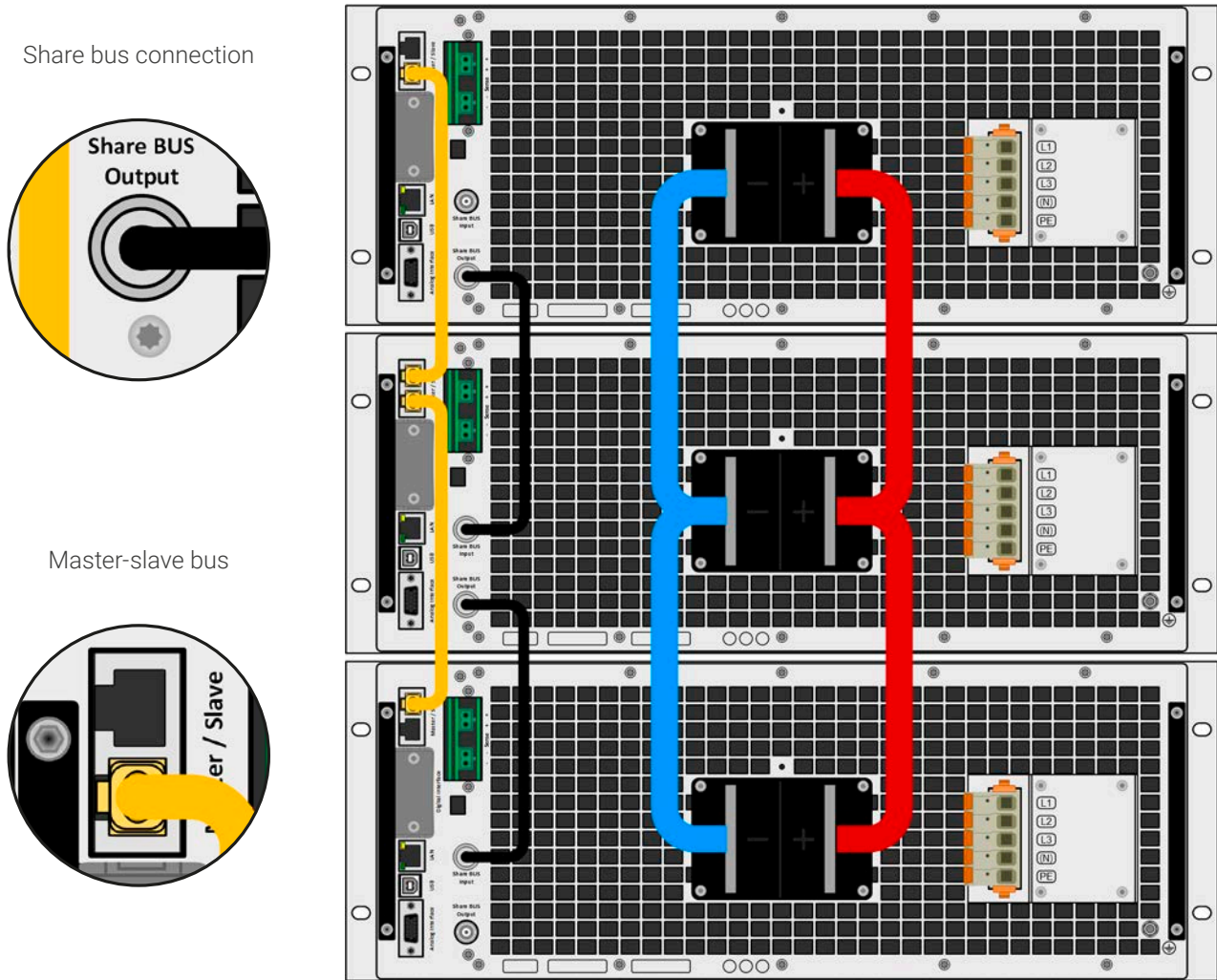

3.10.1.1 Restrictions

Compared to normal operation of a single device, master-slave operation has some restrictions:

- The MS system reacts partly different in alarm situations (see below in 3.10.1.8)
- Using the Share bus makes the system react as dynamic as possible, but it's still not as dynamic as single unit operation
- Connection to identical models from other series is supported, but limited to series PSI 10000 models which can serve as master units for which the PS 10000 are considered as cheaper slave units

3.10.1.2 Wiring the DC outputs

The DC output of every unit in the parallel operation is connected with correct polarity to the next unit, using cables or copper bars with a cross section according to the total system current and with short as possible length, so their inductance is as low as possible. The same applies when building several blocks of devices, i. e. a block of power supplies and a block of electronic load, to later connect them in two-quadrant operation. The blocks should be placed as close as possible to each other.

3.10.1.3 Wiring the Share bus

The Share bus is wired from unit to unit with standard BNC cables (coaxial, 50 Ω type) with a length of 0.5 m (1.64 ft) or similar. Both sockets are internally connected and are not specifically input or output. The labeling is only for orientation.

3.10.1.4 Wiring and set-up of the digital master-slave bus

The master-slave connectors are built-in and can be connected via network cables (≥CAT3, patch cable). After this, MS can be configured manually (recommended) or by remote control. The following applies:

- A maximum of 64 units can be connected via the bus: 1 master and up to 63 slaves.
- Connection only between devices of same kind, i.e. power supply to power supply; connection of different power classes is allowed and supported, e. g. one 15 kW 3U with one 30 kW 4U to achieve a total of 45 kW, but requires to have at least firmware KE/HMI 3.02 installed on all units
- Linking different series is supported, but limited to:
 - PS 10000 series models can be used as slave units for PSI 10000 series models being the master unit
- Units at the end of the bus should be terminated, if necessary (see below for more information)



The master-slave bus must not be wired using crossover cables!

Later operation of the MS system implies:

- The master unit displays, or makes available to be read by the remote controller, the sum of the actual values of all the units
- The ranges for setting the values, adjustment limits, protections (OVP etc.) of the master are adapted to the total number of units. Thus, if e.g. 5 units each with a power of 30 kW are connected together to a 150 kW system, then the master can be set in the range 0...150 kW.
- Slaves are no operable as long as being controlled by the master
- Slaves which haven't yet been initialized by the master will show the alarm **MSP** in the display. The same alarm is signaled upon MS bus errors.

► How to connect the digital master-slave bus

1. Switch off all units and connect the master-slave bus with network cables (CAT3 or better, cables not included). It doesn't matter which of the two master-slave sockets (RJ45, backside) is connected to the next unit.
2. Depending on the desired configuration the units are then also connected at their DC terminals. The two units at the beginning and end of the chain must be terminated, while the master requires a separate setting. See table below.

Termination is done with internal electronic switches which are controlled from within the **Settings** menu of the device in group **Master-slave**. This can be done as part of setting up every unit as master or slave, but should be done before the master is going to be set as **Master**, because doing so immediately triggers a bus initialization. In group **Master-Slave** the termination resistors for BIAS and the bus itself (TERM, see figure to the right) can be set separately. Settings matrix for the units on the MS bus:

Device position	Termination setting(s)
Master (at end of bus)	BIAS + TERM
Master (central in bus)	BIAS
Slave (at end of bus)	TERM
Slave (central in bus)	-

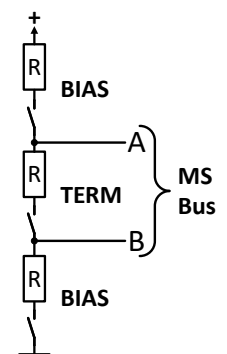

3.10.1.5 Mixed systems

As mixed systems following is understood:

- Different power classes, like 5 kW, 15 kW or 30 kW within one master-slave system (requires at least firmware KE 3.02)
- Different series, specifically PSI 10000 series in connection with PS 10000 series (requires at least firmware KE 3.02)

When connecting devices with different feature sets it makes sense to select the one with the best configuration as master. Combining different power classes can have an unexpected side effect, such that the resulting total power, as displayed by the master after the initialization, isn't the expected one, but lower. This depends on what unit and power class has been picked as master. In such a situation the golden rule is: always select the master from the units with the highest power rating.

Example: you want to connect a 30 kW unit and a 3kW unit in order to achieve 33 kW. Generally, the voltage rating must match, but current and power rating can be different. To be precise, the power rating is decisive. When using the 3 kW unit as master, the total system power will only be 28 kW (with a master running firmware KE 3.02), which is even less than the single 30 kW unit. When, however, switching the master to the 30 kW unit, the system will result in 33 kW total power.

3.10.1.6 Configuring the master-slave operation

Now the master-slave system has to be configured on each unit. It's recommended to configure all the slave units first and then the master unit.

► Step 1: Configuring all slave units

1. While the DC output is switched off, tap on  in the main screen to access the **Settings** menu. Swipe up to find group **Master-slave** and tap it.
2. Tapping on the blue button text next to **Mode** will open a selector. By selecting **Slave**, if not already set, the master-slave mode is activated and the device is defined as slave. Additionally, the bus termination can be activated here, if required for the currently configured unit.
3. Leave the Settings menu.

After this, the slave is fully configured for master-slave. Repeat the procedure for all other slave units.

► Step 2: Configuring the master unit

1. While the DC output is switched off, tap on  in the main screen to access the **Settings** menu. Swipe up to find group **Master-slave** and tap it.
2. Tapping on the blue button text next to **Mode** will open a selector. By selecting **Master**, if not already set, the master-slave mode is activated and the device is defined as master which also automatically enable the BIAS resistor termination, as required for the master.

► Step 3: Initializing the master

When setting a device to Master, it will instantly start to initialize the MS system and the result is displayed in the very same window. In case the initialization is not successful or the number of units or the total power is wrong, it can be repeated in this screen anytime.

Initialization state	Initialized
Number of slaves	1
System voltage	80.00V
System current	2000.0A
System power	60.00kW
System resistance	5.0000Ω
Initialize system	

Tapping **Initialize system** repeats the search for slaves in case the detected number of slaves is less than expected, the system has been reconfigured, not all slave units are already set as **Slave** or the cabling/termination is still not OK. The result window shows the number of slaves plus the total current, power and resistance of the MS system.

In case there are no slaves found at all, the master will still initialize the MS system with only itself.



As long as MS mode remains activated, the initialization process of the master-slave system will be repeated each time the master unit is powered. The initialization can also be repeated manually anytime via the Settings menu, in group "Master-Slave".

3.10.1.7 Operating the master-slave system

After successful configuration and initialization of the master and slave units, they will show their status in the in the status area of their displays. The master would show **MS mode: Master** while the slave(s) would show **MS mode: Slave** plus **Remote: Master-slave**, as long they are in remote control from the master.

From now on the slaves can no longer be controlled manually or remotely, neither via the analog nor via digital interfaces. They can, if needed, be monitored via these interfaces by reading actual values and status.

The display on the master unit will reconfigure after initialization and all set values are reset. The master now displays the set and actual values of the total system. Depending on the number of units, the adjustable current and power range will multiply, while the resistance range will decrease. Then following applies:

- The system, represented by the master, can be treated like a standalone unit
- The master shares the set values etc. across the slaves and controls them
- The master is remotely controllable via the analog or digital interfaces
- All settings for the set values U, I, P and R on the master, plus also all related values from supervision, limits etc. should be adapted to the new total values
- All initialized slaves will reset any limits (U_{Min} , I_{Max} etc.), supervision thresholds (OVP, OPP etc.) to default values, so these don't interfere the control by the master. As soon as these values are modified on the master, they are transferred 1:1 to the slaves. Later, during operation, it might occur that a slave causes an alarm earlier than the master, due to imbalanced current or slightly faster reaction.



In order to easily restore all these settings to what was configured before activating MS operation, it's recommended to make use of the user profiles (see "3.9. Loading and saving user profiles")

- If one or more slaves report a device alarm, it will be signaled on the master and must be acknowledged also there. so that the slave(s) can continue their operation. Since an alarm causes the DC outputs to be switched off and can only reinstate the on/off condition automatically after PF or OT alarms, where the reaction to the alarms is configurable, action from an operator or a remote control software may become necessary.
- Loss of connection to any slave will result in shutdown of all DC outputs as a safety measure and the master will report this situation in the display with a pop-up telling "Master-slave security mode". Then the MS system has to be re-initialized, either with or without prior re-establishment of the connection to the disconnected unit(s).
- All units, even the slaves, can be externally shut down on their DC outputs using the pin REM-SB of the analog interface. This can be used as some kind of "emergency off", here usually a contact (maker or breaker) is wired to this pin on all units in parallel.

3.10.1.8 Alarms and other problem situations

Master-slave operation, due to the connection of multiple units and their interaction, can cause additional problem situations which do not occur when operating individual units. For such occurrences the following regulations have been defined:

- Generally, if the master loses connection to any slave, it will generate an MSP (master-slave protection) alarm, pop up a message on the screen and switch off its DC output. The slaves will fall back to single operation mode, but also switch off their DC output. The MSP alarm can be deleted by either initializing the master-slave system again. This can be done either in the MSP alarm pop-up screen or in the MENU of the master or via remote control. Alternatively, the alarm is also cleared by deactivating master-slave on the master unit
- If one or more slave units are cut from AC supply (power switch, blackout, supply undervoltage) and come back later, they're not automatically initialized and included again in the MS system. Then the init has to be repeated.
- If the master unit is cut from AC supply (power switch, blackout) and comes back later, the unit will automatically initialize the MS system again, finding and integrating all active slaves. In this case, MS can be restored automatically.
- If multiple units are defined as master the master-slave system can't be initialized

In situations where one or multiple units generate a device alarm like OVP etc. following applies:

- Any alarm of a slave is indicated on the slave's display and on the master's display
- If multiple alarms happen simultaneously, the master only indicates the most recent one. In this case, the particular alarms can be read from the slave units displays or via digital interface during remote control or remote supervision.
- All units in the MS system supervise their own values regarding overvoltage, overcurrent and overpower and in case of alarm they report the alarm to the master. In situations where the current is probably not balanced between the units, it can occur that one unit generates an OCP alarm though the global OCP limit of the MS system was not reached. The same can occur with the OPP alarm.

3.10.2 Series connection

Series connection of two or multiple devices is basically possible. But for reasons of safety and isolation, following restrictions apply:



- Both, negative (DC-) and positive (DC+) output poles, are connected to PE via type X capacitors
- None DC minus pole of any unit in the series connection must have a potential against ground (PE) higher than specified in the technical data! The maximum allowed potential shift varies from model to model and is different for DC plus and DC minus
- Remote sensing must not be used!
- Series connection is only allowed with devices of the same kind and model, i.e. power supply with power supply, and ideally same ratings where especially the current rating should match

Series connection in Master-Slave mode isn't supported. It means, all units have to be controlled separately regarding set values and DC output status, whether it's manual control or remote control (digital or analog).

Due to the max. allowed potential shift on the DC output certain models are not allowed for series connection at all, like the 1000 V model, because the DC plus there is only isolated up to 1000 V. On the contrary, two 500 V models are eligible for series connection.

Analog interfaces on the units in serial connection can be connected in parallel, because they are galvanically isolated. It's also allowed to ground the GND pins of the analog interfaces connected in parallel, which may happen automatically, when connecting them to a controlling device such as a PC, where grounds are directly tied to PE.

3.10.3 SEMI F47

SEMI F47 (the SEMI comes from semiconductor) is a specification that demands a device to continue working without interruption in case of a power failure in form of an AC supply undervoltage (here: sag) of max. -50% of the rated line voltage with a max. duration of 1.7 seconds. From firmware KE 3.02 and HMI 3.02 this has been implemented for all 10000 series devices, but cannot be obtained by installing an update.

SEMI F47 specifies a voltage sag in steps with increasing voltage:

Sag of	Duration at 50 Hz	Duration at 60 Hz	Duration in seconds
50%	10 cycles	12 cycles	0.2
30%	25 cycles	30 cycles	0.5
20%	50 cycles	60 cycles	1 s

3.10.3.1 Restrictions

- The feature will be disabled automatically and also locked if the device boots with low AC supply voltage present, i. e. 208 V (L-L) instead of the default 400 V (L-L), so it could not bridge the 1.7 s duration of the F47 pulse anymore. It means that SEMI F47 isn't available while derating is active.
- It requires a decreased max. power, compared to the rated power of the particular model, thus SEMI F47 is also a sort of derating, but it's not depending on the line voltage but what the AC input circuit (PFC) can cover without running into a power fail. This reduced power rating is activated and deactivated together with SEMI F47

3.10.3.2 Adjustments

SEMI F47 can either be activated/deactivated manually on the HMI (see 3.4.3.1) or a digital interface, unless blocked due to the current device state.

3.10.3.3 Application

The feature can be activated at any time, unless blocked to the current devices, for example when low voltage derating is already active (see 3.2.3.7). When activating it sometime during normal operation, the device will pop up a message after leaving the menu, informing about the altered situation and also instantly reduce the max. available power, as well as adjust the power set values, should the currently be higher than the new maximum. When deactivating the feature it goes vice versa, only the power set values remain unaltered then. Due to the fact that the setting is stored beyond shutting down the device, it could directly boot into SEMI F47 mode during next start, also showing that above mentioned pop-up once after the start (the pop-up can be deactivated).

If later a voltage sag occurs, the level of sag or the duration decides whether the device continues its operation without switching the DC output off or if it would show a **PF** alarm. Without SEMI F47 being activated, the PF alarm would appear immediately while with activated SEMI F47 it's delayed for at least 2 seconds or will never occur. In this case, the device wouldn't show any reaction to the sag, nor register the occurrence in any form.

4. Service and maintenance

4.1 Maintenance / cleaning

The device needs no maintenance. Cleaning may be needed for the internal fans, the frequency of cleanse is depending on the ambient conditions. The fans serve to cool the components which are heated by the inherent power loss. Heavily dirt filled fans can lead to insufficient airflow and therefore the DC output would switch off too early due to overheating or possibly lead to defects.

In case there is requirement for such a maintenance, please contact us.

4.1.1 Battery replacement

The device contains a Lithium cell battery of type CR2032, which is placed on the so-called KE board that is mounted to the right-hand side wall (when looking from the front) of the device. The battery is specified for a life span of at least 5 years, but due to ambient condition, especially temperature, this span could be lower. The battery is used to buffer the internal real-time clock and if it becomes necessary to replace the battery, it can be done on location by a qualified person while maintaining typical ESD precautionary measures. The KE board would have to be loosened and lifted up carefully to access the battery.

4.2 Fault finding / diagnosis / repair

If the equipment suddenly performs in an unexpected way, which indicates a fault, or it has an obvious defect, this can't and must not be repaired by the user. Contact the supplier in case of suspicion and elicit the steps to be taken.

It will then usually be necessary to return the device to the supplier (with or without guarantee). If a return for checking or repair is to be carried out, ensure that:

- the supplier has been contacted and it's clarified how and where the equipment should be sent.
- the device is in fully assembled state and in suitable transport packaging, ideally the original packaging.
- optional extras such as an interface module is included if this is in any way connected to the problem.
- a fault description in as much detail as possible is attached.
- if shipping destination is abroad, the necessary customs papers are attached.

4.2.1 Firmware updates



Firmware updates should only be installed when they can eliminate existing bugs in the firmware in the device or contain new features.

The firmware of the control panel (HMI), of the communication unit (KE) and the digital controller (DR), if necessary, is updated via the rear side USB port. For this the software EA Power Control is needed which is included with the device or available as download from our website together with the firmware update, or upon request.

However, be advised not to install updates promptly. Every update includes the risk of an inoperable device or system. We recommend to install updates only if...

- an imminent problem with your device can be solved directly, especially if we suggested to install an update during a support case
- a new feature has been added which you definitely want to use. In this case, the full responsibility is transferred to you.

Following also applies in connection with firmware updates:

- Simple changes in firmwares can have crucial effects on the application the devices are use in. We thus recommend to study the list of changes in the firmware history very thoroughly.
- Newly implemented features may require an updated documentation (user manual and/or programming guide, as well as LabView VIs), which is often delivered only later, sometimes significantly later

4.2.2 Trouble-shooting device problems

Problem situation	Possible hazard	Probability	Safety measures to take by the operator	Residual risk
A voltage source with reversed polarity has been connected to the DC terminal	Damage of the internal secondary power stage	Low	With all application that require to connect an external source to the device, especially if the source is a battery, attach an extra warning sign onto the device which instructs the user to be extra careful, watching the polarity. As an additional measure include fuses in line with the DC cables which could attenuate or even prevent damage to the device.	Low

5. Contact and support

5.1 General

Repairs, if not otherwise arranged between supplier and customer, will be carried out by the manufacturer. For this the device must generally be returned to the manufacturer. No RMA number is needed. It's sufficient to package the equipment adequately and send it, together with a detailed description of the fault and, if still under guarantee, a copy of the invoice, to the following address.

5.2 Contact options

Questions or problems with operation of the device, use of optional components, with the documentation or software, can be addressed to technical support either by telephone or e-Mail.

Headquarter	eMail addresses	Telephone
EA Elektro-Automatik GmbH Helmholtzstr. 31-37 41747 Viersen Germany	Technical support: support@elektroautomatik.com All other issues: ea1974@elektroautomatik.com	Switchboard: +49 2162 / 37850 Support: +49 2162 / 378566

EA Elektro-Automatik GmbH & Co. KG

Helmholtzstr. 31-37
41747 Viersen

Phone: +49 2162 3785 - 0
Fax: +49 2162 16230
ea1974@elektroautomatik.com

www.elektroautomatik.com

EA Elektro-Automatik Inc.

7926 Convoy Court
CA, 92111, San Diego

Phone: +1 (858) 836 1300
sales@elektroautomatik.com

