



# GL6-F2411V

G6

MINIATURE PHOTOELECTRIC SENSORS

**SICK**  
Sensor Intelligence.



Illustration may differ

**ECOLAB**



### Ordering information

Type	Part no.
GL6-F2411V	1084101

Other models and accessories → [www.sick.com/G6](http://www.sick.com/G6)

### Detailed technical data

#### Features

<b>Functional principle</b>	Photoelectric retro-reflective sensor	
<b>Functional principle detail</b>	Dual lens	
<b>Sensing range max.</b>	0.03 m ... 6 m <sup>1)</sup>	
<b>Sensing range</b>	0.07 m ... 5 m <sup>1)</sup>	
<b>Polarisation filters</b>	Yes	
<b>Emitted beam</b>	Light source	PinPoint LED <sup>2)</sup>
	Type of light	Visible red light
	Light spot size (distance)	Ø 8 mm (350 mm)
<b>Key LED figures</b>	Wave length	650 nm
<b>Adjustment</b>	Potentiometer, 270°	
<b>Special applications</b>	Hygienic and washdown zones	

<sup>1)</sup> Reflector PL80A.

<sup>2)</sup> Average service life: 100,000 h at T<sub>U</sub> = +25 °C.

#### Electrical data

<b>Supply voltage U<sub>B</sub></b>	10 V DC ... 30 V DC <sup>1)</sup>
-------------------------------------	-----------------------------------

<sup>1)</sup> Limit values when operated in short-circuit protected network: max. 8 A.

<sup>2)</sup> May not exceed or fall below U<sub>V</sub> tolerances.

<sup>3)</sup> Without load.

<sup>4)</sup> At U<sub>V</sub> > 24 V, I<sub>A</sub> max. = 50 mA.

<sup>5)</sup> Signal transit time with resistive load.

<sup>6)</sup> With light/dark ratio 1:1.

<sup>7)</sup> A = V<sub>S</sub> connections reverse-polarity protected.

<sup>8)</sup> B = inputs and output reverse-polarity protected.

<sup>9)</sup> D = outputs overcurrent and short-circuit protected.

<b>Ripple</b>	$\pm 10\%$ <sup>2)</sup>
<b>Current consumption</b>	30 mA <sup>3)</sup>
<b>Protection class</b>	III
<b>Digital output</b>	
Type	PNP
Switching mode	Light/dark switching
Signal voltage PNP HIGH/LOW	$V_S - (\leq 3\text{ V}) / \text{approx. } 0\text{ V}$
Output current $I_{\text{max}}$	$\leq 100\text{ mA}$ <sup>4)</sup>
Response time	$< 625\ \mu\text{s}$ <sup>5)</sup>
Switching frequency	1,000 Hz <sup>6)</sup>
<b>Output function</b>	Complementary switching output
<b>Circuit protection</b>	A <sup>7)</sup> B <sup>8)</sup> D <sup>9)</sup>

<sup>1)</sup> Limit values when operated in short-circuit protected network: max. 8 A.

<sup>2)</sup> May not exceed or fall below  $U_V$  tolerances.

<sup>3)</sup> Without load.

<sup>4)</sup> At  $U_V > 24\text{ V}$ ,  $I_A \text{ max.} = 50\text{ mA}$ .

<sup>5)</sup> Signal transit time with resistive load.

<sup>6)</sup> With light/dark ratio 1:1.

<sup>7)</sup> A =  $V_S$  connections reverse-polarity protected.

<sup>8)</sup> B = inputs and output reverse-polarity protected.

<sup>9)</sup> D = outputs overcurrent and short-circuit protected.

## Mechanical data

<b>Housing</b>	Rectangular
<b>Dimensions (W x H x D)</b>	15 mm x 44 mm x 22 mm
<b>Connection</b>	Cable, 4-wire, 2 m <sup>1)</sup>
<b>Connection detail</b>	
Conductor size	0.14 mm <sup>2</sup>
Length of cable (L)	2 m <sup>1)</sup>
<b>Material</b>	
Housing	Stainless steel, Stainless steel V4A (1.4404, 316L)
Front screen	Plastic, PMMA
Cable	PVC
<b>Weight</b>	70 g

<sup>1)</sup> Do not bend below 0 °C.

## Ambient data

<b>Enclosure rating</b>	IP67 IP69K <sup>1)</sup>
<b>Ambient operating temperature</b>	-25 °C ... +55 °C <sup>2)</sup>
<b>Ambient temperature, storage</b>	-30 °C ... +75 °C

<sup>1)</sup> According to ISO 20653:2013-03.

<sup>2)</sup> Temperature stability following adjustment +/-10 °C.

<b>UL File No.</b>	NRKH.E348498 & NRKH7.E348498
--------------------	------------------------------

<sup>1)</sup> According to ISO 20653:2013-03.

<sup>2)</sup> Temperature stability following adjustment +/-10 °C.

### Classifications

<b>ECLASS 5.0</b>	27270902
<b>ECLASS 5.1.4</b>	27270902
<b>ECLASS 6.0</b>	27270902
<b>ECLASS 6.2</b>	27270902
<b>ECLASS 7.0</b>	27270902
<b>ECLASS 8.0</b>	27270902
<b>ECLASS 8.1</b>	27270902
<b>ECLASS 9.0</b>	27270902
<b>ECLASS 10.0</b>	27270902
<b>ECLASS 11.0</b>	27270902
<b>ECLASS 12.0</b>	27270902
<b>ETIM 5.0</b>	EC002717
<b>ETIM 6.0</b>	EC002717
<b>ETIM 7.0</b>	EC002717
<b>ETIM 8.0</b>	EC002717
<b>UNSPSC 16.0901</b>	39121528

### Connection diagram

Cd-094

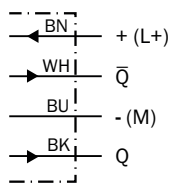

### Characteristic curve

GL6 Inox, Red, Standard

Function reserve

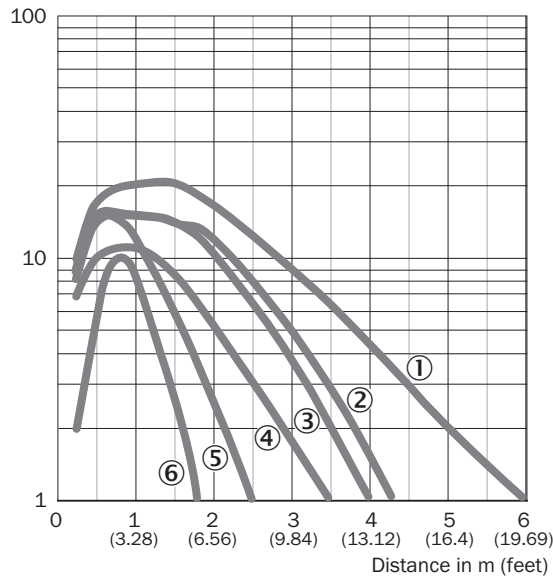

- ① Reflector PL80A
- ② Reflector PL40A
- ③ Reflector P250
- ④ Reflector P250 CHEM
- ⑤ Reflector PL20A
- ⑥ Reflective tape REF-IRF-56

### Light spot size

GL6 Inox, Red, Standard

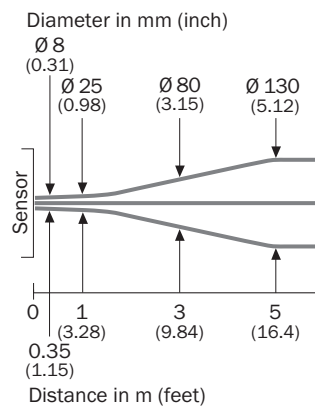

### Sensing range diagram

GL6 Inox, Red, Standard

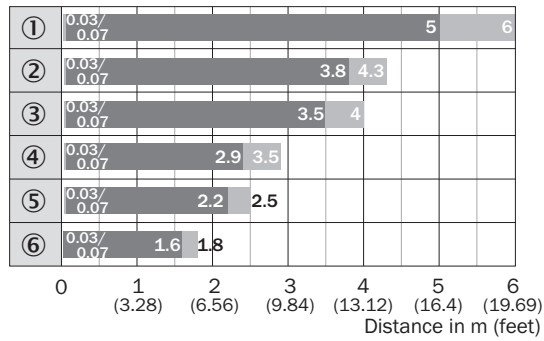

■ Sensing range

■ Sensing range max.

- ① Reflector PL80A
- ② Reflector PL40A
- ③ Reflector P250
- ④ Reflector P250 CHEM
- ⑤ Reflector PL20A
- ⑥ Reflective tape REF-IRF-56

**Dimensional drawing** (Dimensions in mm (inch))

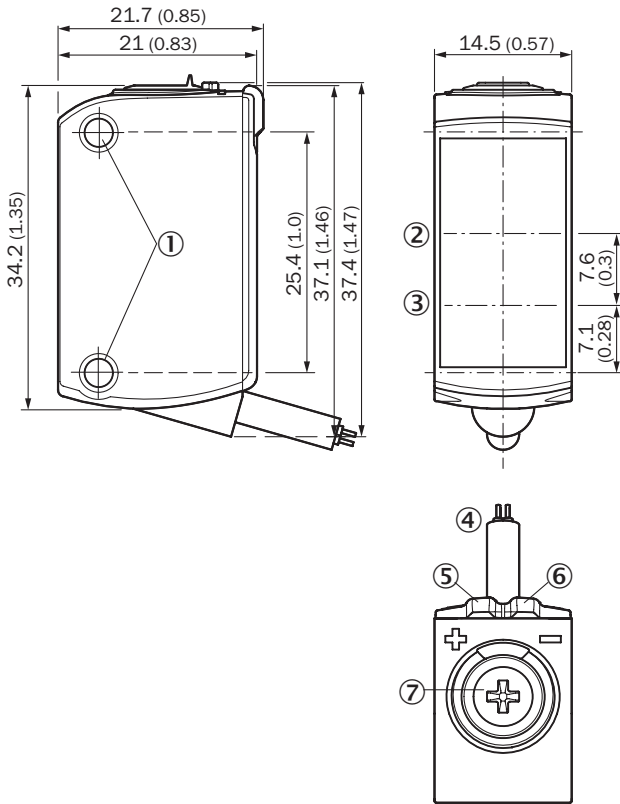

GTB6, GTE6, GL6, GSE6 Inox, cable (with male connector)





- ① M3 mounting hole
- ② Optical axis, receiver
- ③ Optical axis, sender
- ④ Connection
- ⑤ LED indicator yellow: Status of received light beam
- ⑥ LED indicator green: Supply voltage active
- ⑦ Potentiometer

**Recommended accessories**

Other models and accessories → [www.sick.com/G6](http://www.sick.com/G6)

	Brief description	Type	Part no.
<b>Universal bar clamp systems</b>			
	Clamp bar to fix G6 sensors on rods of 12 mm, clamp-on design up to 4 mm wall thickness, aluminum (clamp bar), stainless steel (bracket), clamp bar mounting and clamp function, mounting bracket, mounting hardware	BEF-KHS-IS12G6	2086865
<b>Mounting brackets and plates</b>			
	Mounting bracket for wall mounting, stainless steel, mounting hardware included	BEF-W100-A	5311520
	Universal mounting bracket for reflectors, steel, zinc coated	BEF-WN-REFX	2064574

	Brief description	Type	Part no.
Plug connectors and cables			
	<ul style="list-style-type: none"> <li>• <b>Connection type head A:</b> Male connector, M8, 4-pin, straight</li> <li>• <b>Description:</b> Unshielded</li> <li>• <b>Connection systems:</b> Screw-type terminals</li> <li>• <b>Permitted cross-section:</b> 0.14 mm² ... 0.5 mm²</li> </ul>	STE-0804-G	6037323
Reflectors			
	Chemically resistant, screw connection, 52 mm x 61 mm, plastic, Screw-on, 2 hole mounting	P250 CHEM	5321097



## SICK AT A GLANCE

SICK is one of the leading manufacturers of intelligent sensors and sensor solutions for industrial applications. A unique range of products and services creates the perfect basis for controlling processes securely and efficiently, protecting individuals from accidents and preventing damage to the environment.

We have extensive experience in a wide range of industries and understand their processes and requirements. With intelligent sensors, we can deliver exactly what our customers need. In application centers in Europe, Asia and North America, system solutions are tested and optimized in accordance with customer specifications. All this makes us a reliable supplier and development partner.

Comprehensive services complete our offering: SICK LifeTime Services provide support throughout the machine life cycle and ensure safety and productivity.

For us, that is “Sensor Intelligence.”

## WORLDWIDE PRESENCE:

Contacts and other locations –[www.sick.com](http://www.sick.com)