



GL6G-P4211S73

G6

MINIATURE PHOTOELECTRIC SENSORS

SICK
Sensor Intelligence.



Illustration may differ



Ordering information

Type	Part no.
GL6G-P4211S73	1086956

Other models and accessories → www.sick.com/G6

Detailed technical data

Features

Functional principle	Photoelectric retro-reflective sensor	
Functional principle detail	Dual lens	
Sensing range max.	≤ 6 m ¹⁾	
Sensing range	≤ 5 m ¹⁾	
Polarisation filters	Yes	
Emitted beam	Light source	PinPoint LED ²⁾
	Type of light	Visible red light
	Light spot size (distance)	Ø 8 mm (350 mm)
Key LED figures	Wave length	650 nm
Adjustment	Potentiometer, 270°	
Special applications	Detecting transparent objects	

¹⁾ Reflector PL80A.

²⁾ Average service life: 100,000 h at T_J = +25 °C.

Electrical data

Supply voltage U_B	10 V DC ... 30 V DC ¹⁾
Ripple	$\pm 10\%$ ²⁾
Current consumption	30 mA ³⁾
Protection class	III
Digital output	
Type	PNP
Switching mode	Light/dark switching
Switching mode selector	Selectable via light/dark selector
Signal voltage PNP HIGH/LOW	$V_S - (\leq 3\text{ V}) / \text{approx. } 0\text{ V}$
Output current I_{max}	$\leq 100\text{ mA}$ ⁴⁾
Response time	$< 625\ \mu\text{s}$ ⁵⁾
Switching frequency	1,000 Hz ⁶⁾
Attenuation along light beam	$> 20\%$
Circuit protection	A ⁷⁾ B ⁸⁾ D ⁹⁾
Special feature	Detecting transparent objects

¹⁾ Limit values when operated in short-circuit protected network: max. 8 A.

²⁾ May not exceed or fall below U_V tolerances.

³⁾ Without load.

⁴⁾ At $U_V > 24\text{ V}$, I_A max. = 50 mA.

⁵⁾ Signal transit time with resistive load.

⁶⁾ With light/dark ratio 1:1.

⁷⁾ A = V_S connections reverse-polarity protected.

⁸⁾ B = inputs and output reverse-polarity protected.

⁹⁾ D = outputs overcurrent and short-circuit protected.

Mechanical data

Housing	Rectangular
Dimensions (W x H x D)	12 mm x 31.5 mm x 21 mm
Connection	Male connector M8, 4-pin
Material	
Housing	Plastic, ABS/PC
Front screen	Plastic, PMMA
Weight	20 g

Ambient data

Enclosure rating	IP67
Ambient operating temperature	$-25\text{ }^\circ\text{C} \dots +55\text{ }^\circ\text{C}$ ¹⁾
Ambient temperature, storage	$-40\text{ }^\circ\text{C} \dots +70\text{ }^\circ\text{C}$
UL File No.	NRKH.E348498 & NRKH7.E348498

¹⁾ Temperature stability following adjustment $\pm 10\text{ }^\circ\text{C}$.

Classifications

ECLASS 5.0	27270902
ECLASS 5.1.4	27270902
ECLASS 6.0	27270902
ECLASS 6.2	27270902
ECLASS 7.0	27270902
ECLASS 8.0	27270902
ECLASS 8.1	27270902
ECLASS 9.0	27270902
ECLASS 10.0	27270902
ECLASS 11.0	27270902
ECLASS 12.0	27270902
ETIM 5.0	EC002717
ETIM 6.0	EC002717
ETIM 7.0	EC002717
ETIM 8.0	EC002717
UNSPSC 16.0901	39121528

Adjustments

Adjustment possibility

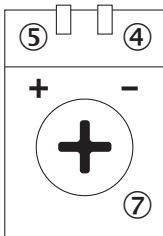

- ④ LED indicator green: Supply voltage active
- ⑤ LED indicator yellow: Status of received light beam
- ⑦ Sensitivity control: potentiometer

Connection type

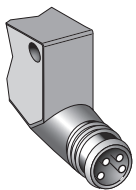

Connection diagram

Cd-066

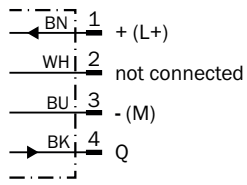

Characteristic curve

Operating reserve

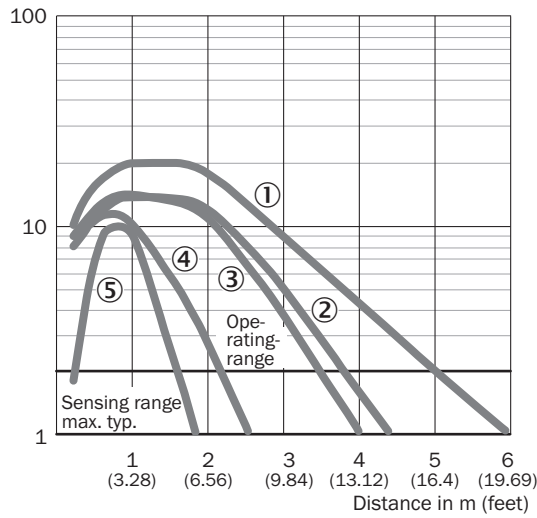

- ① Reflector PL80A
- ② Reflector PL40A
- ③ Reflector P250
- ④ Reflector PL20A
- ⑤ REF-PLUS-R50

Light spot size

GL6, GL6G

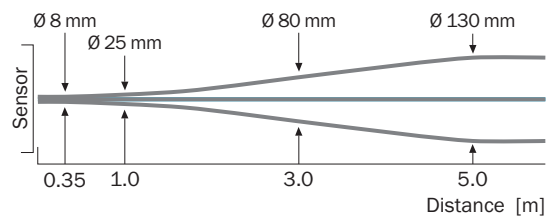

Sensing range diagram

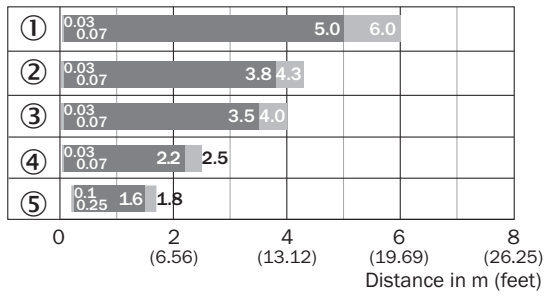

■ Sensing range ■ Sensing range max.

- ① Reflector PL80A
- ② Reflector PL40A
- ③ Reflector P250
- ④ Reflector PL20A
- ⑤ REF-PLUS-R50

Functional principle

Modified output LED indicator logic

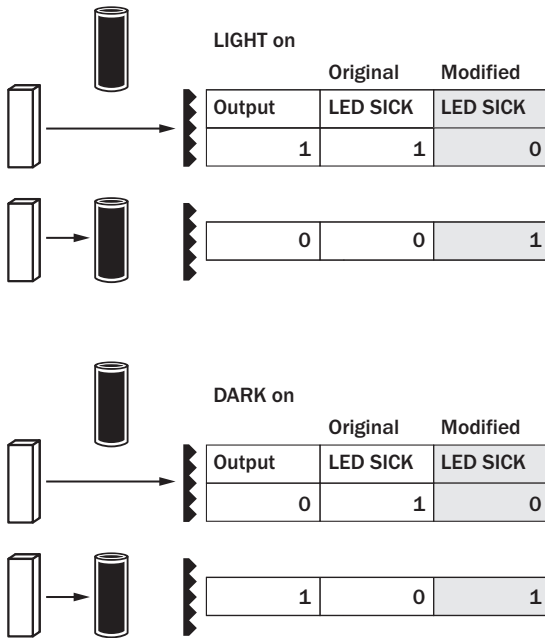



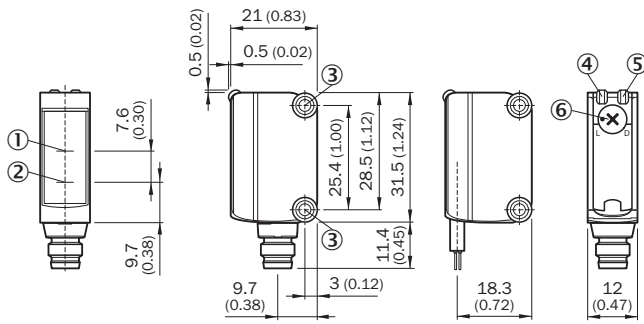



Dimensional drawing (Dimensions in mm (inch))



- ① Optical axis, receiver
- ② Optical axis, sender
- ③ Mounting holes M3
- ④ LED indicator green: Supply voltage active
- ⑤ LED indicator yellow: Status of received light beam
- ⑥ Light/ dark rotary switch: L = light switching, D = dark switching

Recommended accessories

Other models and accessories → www.sick.com/G6

	Brief description	Type	Part no.
Universal bar clamp systems			
	Clamp bar to fix G6 sensors on rods of 12 mm, clamp-on design up to 4 mm wall thickness, aluminum (clamp bar), stainless steel (bracket), clamp bar mounting and clamp function, mounting bracket, mounting hardware	BEF-KHS-IS12G6	2086865
Mounting brackets and plates			
	Stainless steel (1.4301)	BEF-WN-G6	2062909
	Universal mounting bracket for reflectors, steel, zinc coated	BEF-WN-REFX	2064574
Plug connectors and cables			
	<ul style="list-style-type: none"> • Connection type head A: Female connector, M8, 4-pin, straight, A-coded • Connection type head B: Flying leads • Signal type: Sensor/actuator cable • Cable: 5 m, 4-wire, PVC • Description: Sensor/actuator cable, unshielded • Application: Zones with chemicals 	YF8U14-050VA3XLEAX	2095889
	<ul style="list-style-type: none"> • Connection type head A: Male connector, M8, 4-pin, straight • Description: Unshielded • Connection systems: Screw-type terminals • Permitted cross-section: 0.14 mm² ... 0.5 mm² 	STE-0804-G	6037323
Reflectors			
	Rectangular, screw connection, 51 mm x 61 mm, PMMA/ABS, Screw-on, 2 hole mounting	P250	5304812

SICK AT A GLANCE

SICK is one of the leading manufacturers of intelligent sensors and sensor solutions for industrial applications. A unique range of products and services creates the perfect basis for controlling processes securely and efficiently, protecting individuals from accidents and preventing damage to the environment.

We have extensive experience in a wide range of industries and understand their processes and requirements. With intelligent sensors, we can deliver exactly what our customers need. In application centers in Europe, Asia and North America, system solutions are tested and optimized in accordance with customer specifications. All this makes us a reliable supplier and development partner.

Comprehensive services complete our offering: SICK LifeTime Services provide support throughout the machine life cycle and ensure safety and productivity.

For us, that is “Sensor Intelligence.”

WORLDWIDE PRESENCE:

Contacts and other locations –www.sick.com