



WL4S-3F2132V

W4

MINIATURE PHOTOELECTRIC SENSORS

SICK
Sensor Intelligence.



Illustration may differ



Ordering information

| Type | Part no. |
|--------------|----------|
| WL4S-3F2132V | 1046428 |

Other models and accessories → www.sick.com/W4

Detailed technical data

Features

| | |
|------------------------------------|---------------------------------------|
| Functional principle | Photoelectric retro-reflective sensor |
| Functional principle detail | Autocollimation |
| Sensing range max. | 0 m ... 5 m ¹⁾ |
| Sensing range | 0 m ... 3 m ¹⁾ |
| Polarisation filters | Yes |
| Emitted beam | |
| Light source | PinPoint LED ²⁾ |
| Type of light | Visible red light |
| Light spot size (distance) | Ø 45 mm (1.5 m) |
| Key LED figures | |
| Wave length | 650 nm |
| Adjustment | Single teach-in button |
| Special applications | Hygienic and washdown zones |
| Housing design | Washdown |

¹⁾ Reflector PL80A.

²⁾ Average service life: 100,000 h at T_U = +25 °C.

Safety-related parameters

| | |
|-------------------------|-------------|
| MTTF_D | 1,770 years |
| DC_{avg} | 0 % |

| | |
|-------------------------------------|----------|
| T_M (mission time) | 20 years |
|-------------------------------------|----------|

Electrical data

| | |
|-------------------------------------|-----------------------------------|
| Supply voltage U_B | 10 V DC ... 30 V DC ¹⁾ |
| Ripple | < 5 V _{pp} ²⁾ |
| Current consumption | 30 mA ³⁾ |
| Protection class | III |
| Digital output | |
| Type | PNP |
| Switching mode | Dark switching |
| Output current I _{max.} | ≤ 100 mA |
| Response time | < 0.5 ms ⁴⁾ |
| Switching frequency | 1,000 Hz ⁵⁾ |
| Circuit protection | A, B, C ^{6) 7) 8)} |

¹⁾ Limit values, reverse-polarity protected, operation in short-circuit protected network: max. 8 A.

²⁾ May not exceed or fall below U_v tolerances.

³⁾ Without load.

⁴⁾ Signal transit time with resistive load.

⁵⁾ With light/dark ratio 1:1.

⁶⁾ A = V_S connections reverse-polarity protected.

⁷⁾ B = inputs and output reverse-polarity protected.

⁸⁾ C = interference suppression.

Mechanical data

| | |
|-------------------------------|---|
| Housing | Rectangular |
| Design detail | Slim |
| Dimensions (W x H x D) | 15.25 mm x 44.9 mm x 22.2 mm |
| Connection | Connector M8, 3-pin ¹⁾ |
| Material | |
| Housing | Stainless steel, Stainless steel V4A (1.4404, 316L) |
| Front screen | Plastic, PMMA |
| Weight | 40 g |

¹⁾ Max. tightening torque: 0.6 Nm.

Ambient data

| | |
|--------------------------------------|--|
| Enclosure rating | IP66 IP67 IP68 IP69K ¹⁾ |
| Ambient operating temperature | -30 °C ... +70 °C ²⁾ -30 °C ... +60 °C |
| Ambient temperature, storage | -30 °C ... +75 °C |
| UL File No. | NRKH.E181493 & NRKH7.E181493 |

¹⁾ Only in case of correctly mounted IP69K connecting cable.

²⁾ At UV ≤ 24 V and IA < 30 mA.

Classifications

| | |
|-----------------------|----------|
| ECLASS 5.0 | 27270902 |
| ECLASS 5.1.4 | 27270902 |
| ECLASS 6.0 | 27270902 |
| ECLASS 6.2 | 27270902 |
| ECLASS 7.0 | 27270902 |
| ECLASS 8.0 | 27270902 |
| ECLASS 8.1 | 27270902 |
| ECLASS 9.0 | 27270902 |
| ECLASS 10.0 | 27270902 |
| ECLASS 11.0 | 27270902 |
| ECLASS 12.0 | 27270902 |
| ETIM 5.0 | EC002717 |
| ETIM 6.0 | EC002717 |
| ETIM 7.0 | EC002717 |
| ETIM 8.0 | EC002717 |
| UNSPSC 16.0901 | 39121528 |

Connection type

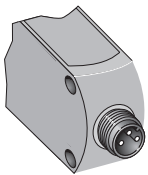

Connection diagram

Cd-045

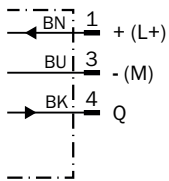

Characteristic curve

WL4S-3, WLG4S-3, 5 m

Operating reserve

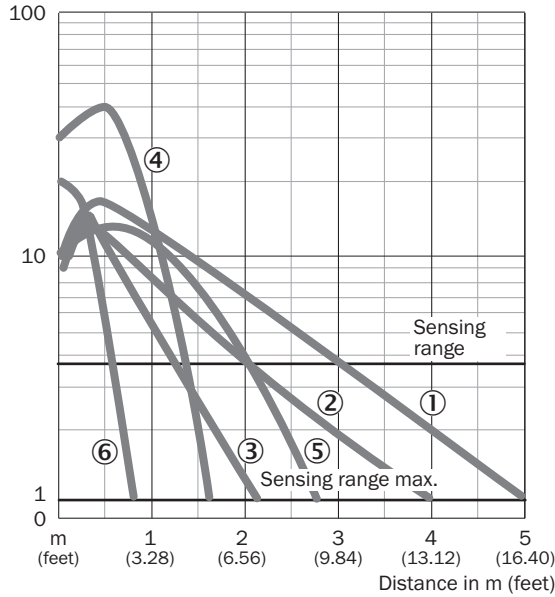

- ① Reflector PL80A
- ② Reflector PL40A
- ③ Reflector PL20A
- ④ PL10F reflector
- ⑤ Reflector P250 CHEM
- ⑥ Reflective tape REF-IRF-56

Sensing range diagram

WL4S-3, WLG4S-3, 5 m

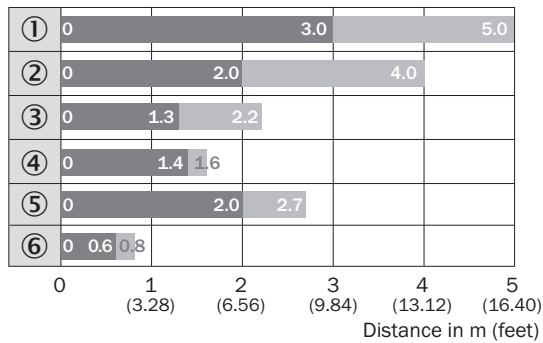

■ Sensing range ■ Sensing range max.

- ① Reflector PL80A
- ② Reflector PL40A
- ③ Reflector PL20A
- ④ PL10F reflector
- ⑤ Reflector P250 CHEM
- ⑥ Reflective tape REF-IRF-56

Dimensional drawing (Dimensions in mm (inch))

WL4S-3V, WLG4S-3V, with single teach-in button

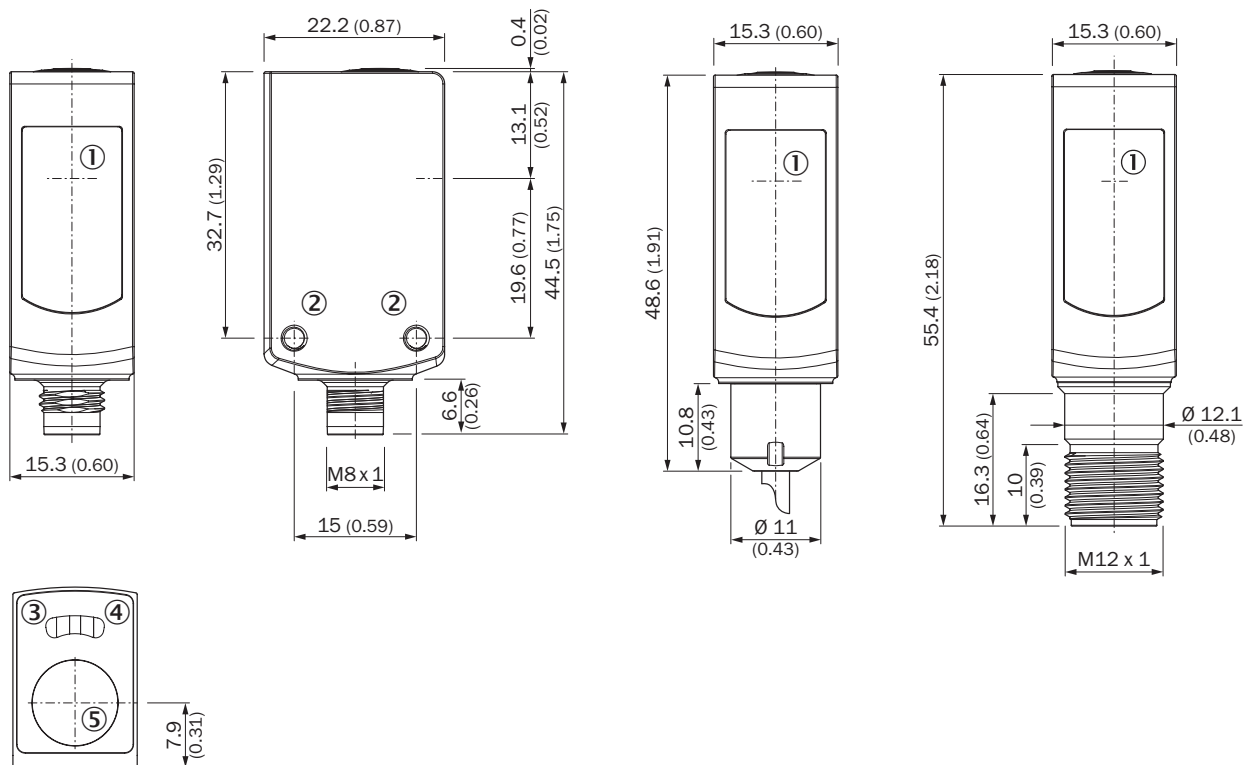



- ① Center of optical axis
- ② Threaded mounting hole M3
- ③ LED indicator yellow: Status of received light beam
- ④ LED indicator green: Supply voltage active
- ⑤ Teach-in button

Recommended accessories

Other models and accessories → www.sick.com/W4

| | Brief description | Type | Part no. |
|---|---|----------|----------|
| Mounting brackets and plates | | | |
|  | Mounting bracket for floor mounting, Stainless steel 1.4571, mounting hardware included | BEF-W4-B | 2051630 |

| | Brief description | Type | Part no. |
|---|--|-----------------|----------|
| Plug connectors and cables | | | |
|  | <ul style="list-style-type: none"> • Connection type head A: Female connector, M8, 3-pin, straight • Connection type head B: Flying leads • Signal type: Sensor/actuator cable • Cable: 5 m, 3-wire, PP • Description: Sensor/actuator cable, unshielded • Connection systems: Flying leads • Note: This product is generally resistant to chemical cleaning agents (see ECOLAB) and other chemical compounds such as H2O2 and CH2O2. Before permanent installation is carried out, the material's resistance to the cleaning agent being used must be checked., Resistant against lactic acid & hydrogen peroxide (H2O2) • Application: Hygienic and washdown zones, Drag chain operation | DOL-0803-G05MRN | 6058505 |
| Reflectors | | | |
|  | Chemically resistant, screw connection, 52 mm x 61 mm, plastic, Screw-on, 2 hole mounting | P250 CHEM | 5321097 |

SICK AT A GLANCE

SICK is one of the leading manufacturers of intelligent sensors and sensor solutions for industrial applications. A unique range of products and services creates the perfect basis for controlling processes securely and efficiently, protecting individuals from accidents and preventing damage to the environment.

We have extensive experience in a wide range of industries and understand their processes and requirements. With intelligent sensors, we can deliver exactly what our customers need. In application centers in Europe, Asia and North America, system solutions are tested and optimized in accordance with customer specifications. All this makes us a reliable supplier and development partner.

Comprehensive services complete our offering: SICK LifeTime Services provide support throughout the machine life cycle and ensure safety and productivity.

For us, that is “Sensor Intelligence.”

WORLDWIDE PRESENCE:

Contacts and other locations –www.sick.com