



WLG4S-3P5232H

W4

MINIATURE PHOTOELECTRIC SENSORS

**SICK**  
Sensor Intelligence.



Illustration may differ



### Ordering information

Type	Part no.
WLG4S-3P5232H	1057053

Other models and accessories → [www.sick.com/W4](http://www.sick.com/W4)

### Detailed technical data

#### Features

<b>Functional principle</b>	Photoelectric retro-reflective sensor
<b>Functional principle detail</b>	Autocollimation
<b>Sensing range max.</b>	0 m ... 5 m <sup>1)</sup>
<b>Sensing range</b>	0 m ... 3 m <sup>1)</sup>
<b>Polarisation filters</b>	Yes
<b>Emitted beam</b>	
Light source	PinPoint LED <sup>2)</sup>
Type of light	Visible red light
Light spot size (distance)	Ø 45 mm (1.5 m)
<b>Key LED figures</b>	
Wave length	650 nm
<b>Adjustment</b>	Single teach-in button
<b>Special applications</b>	Hygienic and washdown zones, Detecting transparent objects
<b>Housing design</b>	Hygiene
<b>AutoAdapt</b>	✓

<sup>1)</sup> Reflector PL80A.

<sup>2)</sup> Average service life: 100,000 h at T<sub>J</sub> = +25 °C.

#### Safety-related parameters

<b>MTTF<sub>D</sub></b>	1,232 years
-------------------------	-------------

<b>DC<sub>avg</sub></b>	0 %
-------------------------	-----

### Electrical data

<b>Supply voltage U<sub>B</sub></b>	10 V DC ... 30 V DC <sup>1)</sup>
<b>Ripple</b>	< 5 V <sub>pp</sub> <sup>2)</sup>
<b>Current consumption</b>	30 mA <sup>3)</sup>
<b>Protection class</b>	III
<b>Digital output</b>	
Type	PNP
Switching mode	Light/dark switching
Output current I <sub>max.</sub>	≤ 100 mA
Response time	< 0.5 ms <sup>4)</sup>
Switching frequency	1,000 Hz <sup>5)</sup>
<b>Attenuation along light beam</b>	> 8 %
<b>Circuit protection</b>	A, B, C <sup>6) 7) 8)</sup>
<b>Special feature</b>	Detecting transparent objects, D12 adapter shaft

<sup>1)</sup> Limit values, reverse-polarity protected, operation in short-circuit protected network: max. 8 A.

<sup>2)</sup> May not exceed or fall below U<sub>v</sub> tolerances.

<sup>3)</sup> Without load.

<sup>4)</sup> Signal transit time with resistive load.

<sup>5)</sup> With light/dark ratio 1:1.

<sup>6)</sup> A = V<sub>S</sub> connections reverse-polarity protected.

<sup>7)</sup> B = inputs and output reverse-polarity protected.

<sup>8)</sup> C = interference suppression.

### Mechanical data

<b>Housing</b>	Rectangular
<b>Design detail</b>	Slim
<b>Dimensions (W x H x D)</b>	15.25 mm x 63.2 mm x 22.15 mm
<b>Connection</b>	Male connector M8, 4-pin <sup>1)</sup>
<b>Material</b>	
Housing	Stainless steel, Stainless steel V4A (1.4404, 316L)
Front screen	Plastic, PMMA
<b>Weight</b>	140 g

<sup>1)</sup> Max. tightening torque: 0.6 Nm.

### Ambient data

<b>Enclosure rating</b>	IP66 IP67 IP68 IP69K
<b>Ambient operating temperature</b>	-30 °C ... +70 °C <sup>1)</sup> -30 °C ... +60 °C
<b>Ambient temperature, storage</b>	-30 °C ... +75 °C
<b>UL File No.</b>	FDA, UL No. NRKH.E181493 & cUL No. NRKH7.E181493

<sup>1)</sup> At UV ≤ 24 V and IA < 30 mA.

### Classifications

<b>ECLASS 5.0</b>	27270902
<b>ECLASS 5.1.4</b>	27270902
<b>ECLASS 6.0</b>	27270902
<b>ECLASS 6.2</b>	27270902
<b>ECLASS 7.0</b>	27270902
<b>ECLASS 8.0</b>	27270902
<b>ECLASS 8.1</b>	27270902
<b>ECLASS 9.0</b>	27270902
<b>ECLASS 10.0</b>	27270902
<b>ECLASS 11.0</b>	27270902
<b>ECLASS 12.0</b>	27270902
<b>ETIM 5.0</b>	EC002717
<b>ETIM 6.0</b>	EC002717
<b>ETIM 7.0</b>	EC002717
<b>ETIM 8.0</b>	EC002717
<b>UNSPSC 16.0901</b>	39121528

### Connection diagram

Cd-083

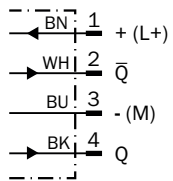

### Characteristic curve

WL4S-3, WLG4S-3, 5 m

Operating reserve

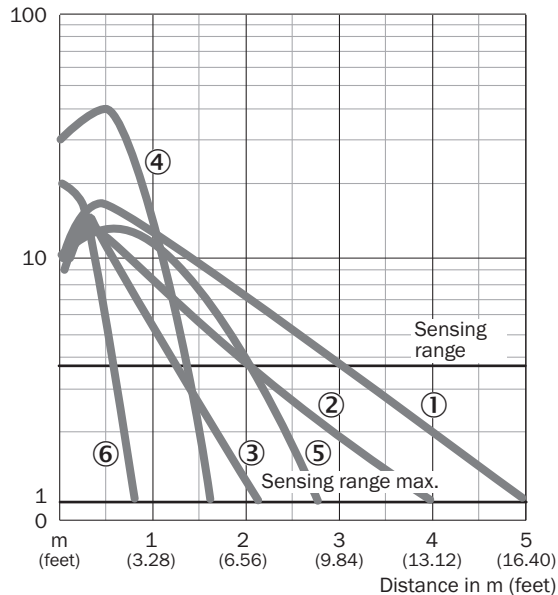

- ① Reflector PL80A
- ② Reflector PL40A
- ③ Reflector PL20A
- ④ PL10F reflector
- ⑤ Reflector P250 CHEM
- ⑥ Reflective tape REF-IRF-56

### Sensing range diagram

WL4S-3, WLG4S-3, 5 m

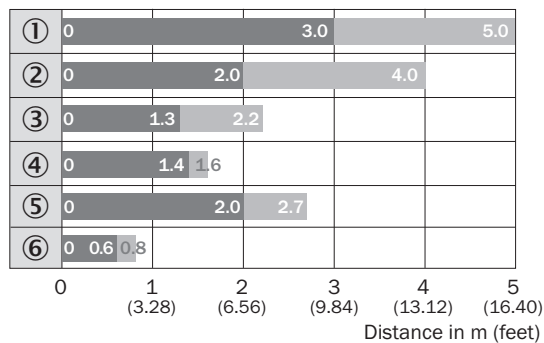

■ Sensing range      ■ Sensing range max.

- ① Reflector PL80A
- ② Reflector PL40A
- ③ Reflector PL20A
- ④ PL10F reflector
- ⑤ Reflector P250 CHEM
- ⑥ Reflective tape REF-IRF-56

**Dimensional drawing** (Dimensions in mm (inch))

WL4S-3H, WLG4S-3H, without single teach-in button, D12 adapter shaft, I-adaption

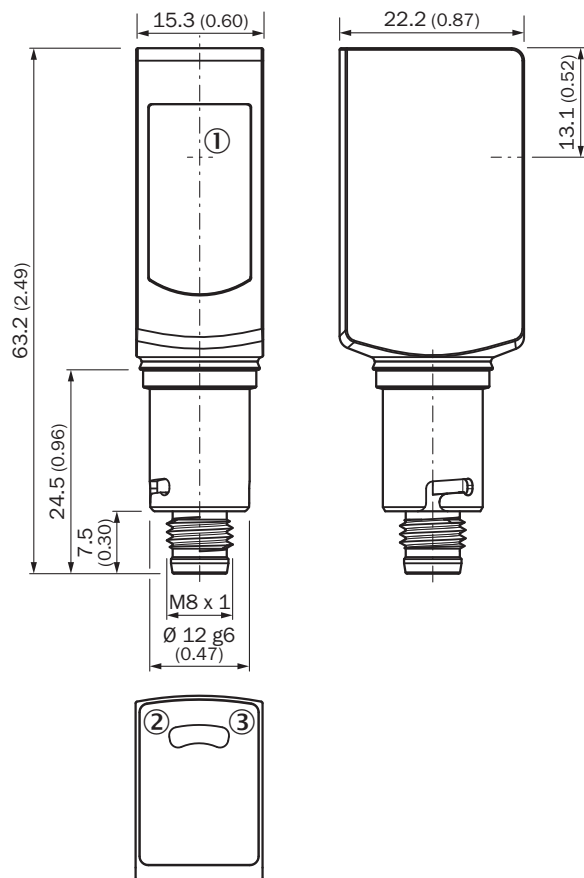



- ① Center of optical axis
- ② LED indicator green: Supply voltage active
- ③ LED indicator yellow: Status of received light beam

**Recommended accessories**

Other models and accessories → [www.sick.com/W4](http://www.sick.com/W4)

	Brief description	Type	Part no.
Other mounting accessories			
	Diameter 18 mm x 100 mm for W4S-3 Inox hygiene. Hygienic integration without holes and brackets. Cable run inside tube	BEF-MR18G-NA	4065853

	Brief description	Type	Part no.
Plug connectors and cables			
	<ul style="list-style-type: none"> <li>• <b>Connection type head A:</b> Female connector, M8, 4-pin, straight</li> <li>• <b>Connection type head B:</b> Flying leads</li> <li>• <b>Signal type:</b> Sensor/actuator cable</li> <li>• <b>Cable:</b> 5 m, 4-wire, PVC</li> <li>• <b>Description:</b> Sensor/actuator cable, unshielded</li> <li>• <b>Connection systems:</b> Flying leads</li> <li>• <b>Note:</b> This product is generally resistant to chemical cleaning agents (see ECOLAB). Please do not use cleaning agents of any other Kind., Not resistant against lactic acid &amp; hydrogen peroxide (H2O2)</li> <li>• <b>Application:</b> Hygienic and washdown zones</li> </ul>	DOL-0804-G05MNI	6059194
Reflectors			
	Chemically resistant, screw connection, 52 mm x 61 mm, plastic, Screw-on, 2 hole mounting	P250 CHEM	5321097

## SICK AT A GLANCE

SICK is one of the leading manufacturers of intelligent sensors and sensor solutions for industrial applications. A unique range of products and services creates the perfect basis for controlling processes securely and efficiently, protecting individuals from accidents and preventing damage to the environment.

We have extensive experience in a wide range of industries and understand their processes and requirements. With intelligent sensors, we can deliver exactly what our customers need. In application centers in Europe, Asia and North America, system solutions are tested and optimized in accordance with customer specifications. All this makes us a reliable supplier and development partner.

Comprehensive services complete our offering: SICK LifeTime Services provide support throughout the machine life cycle and ensure safety and productivity.

For us, that is “Sensor Intelligence.”

## WORLDWIDE PRESENCE:

Contacts and other locations –[www.sick.com](http://www.sick.com)