



WSE4S-3P2130V

W4

MINIATURE PHOTOELECTRIC SENSORS

SICK
Sensor Intelligence.



Illustration may differ



Ordering information

Type	Part no.
WSE4S-3P2130V	1052893

Other models and accessories → www.sick.com/W4

Detailed technical data

Features

Functional principle	Through-beam photoelectric sensor
Sensing range max.	0 m ... 5 m
Sensing range	0 m ... 4.5 m
Emitted beam	
Light source	PinPoint LED ¹⁾
Type of light	Visible red light
Light spot size (distance)	Ø 50 mm (2 m)
Key LED figures	
Wave length	650 nm
Adjustment	None
Special applications	Hygienic and washdown zones
Part number of individual components	2058639 WS4S-3D2130V 2058749 WE4S-3P2130V
Housing design	Washdown

¹⁾ Average service life: 100,000 h at T_J = +25 °C.

Safety-related parameters

MTTF_D	753 years
DC_{avg}	0 %
T_M (mission time)	20 years

Electrical data

Supply voltage U_B	10 V DC ... 30 V DC ¹⁾
Ripple	< 5 V _{pp} ²⁾
Protection class	III
Digital output	
Type	PNP
Switching mode	Light switching
Output current I_{max}	≤ 100 mA
Response time	< 0.5 ms ³⁾
Switching frequency	1,000 Hz ⁴⁾
Circuit protection	A, B, C ^{5) 6) 7)}
Test input sender off	TE to 0 V

¹⁾ Limit values, reverse-polarity protected, operation in short-circuit protected network: max. 8 A.

²⁾ May not exceed or fall below U_V tolerances.

³⁾ Signal transit time with resistive load.

⁴⁾ With light/dark ratio 1:1.

⁵⁾ A = V_S connections reverse-polarity protected.

⁶⁾ B = inputs and output reverse-polarity protected.

⁷⁾ C = interference suppression.

Mechanical data

Housing	Rectangular
Design detail	Slim
Dimensions (W x H x D)	15.25 mm x 44.5 mm x 22.2 mm
Connection	Connector M8, 3-pin ¹⁾
Material	
Housing	Stainless steel, Stainless steel V4A (1.4404, 316L)
Front screen	Plastic, PMMA
Weight	40 g

¹⁾ Max. tightening torque: 0.6 Nm.

Ambient data

Enclosure rating	IP66 IP67 IP68 IP69K ¹⁾
Ambient operating temperature	-30 °C ... +70 °C ²⁾
Ambient temperature, storage	-30 °C ... +75 °C
UL File No.	NRKH.E181493 & NRKH7.E181493

¹⁾ Only in case of correctly mounted IP69K connecting cable.

²⁾ At $U_V \leq 24$ V and $I_A < 30$ mA.

Classifications

ECLASS 5.0	27270901
ECLASS 5.1.4	27270901
ECLASS 6.0	27270901

ECLASS 6.2	27270901
ECLASS 7.0	27270901
ECLASS 8.0	27270901
ECLASS 8.1	27270901
ECLASS 9.0	27270901
ECLASS 10.0	27270901
ECLASS 11.0	27270901
ECLASS 12.0	27270901
ETIM 5.0	EC002716
ETIM 6.0	EC002716
ETIM 7.0	EC002716
ETIM 8.0	EC002716
UNSPSC 16.0901	39121528

Connection type

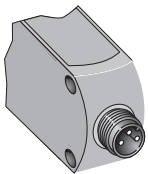

Connection diagram

Cd-069

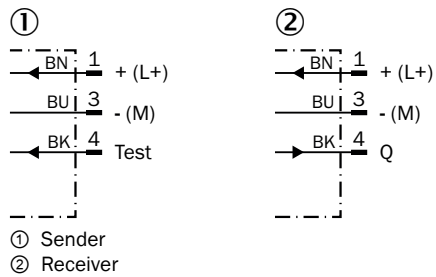

Characteristic curve

WSE4S-3V, WSE4S-3H

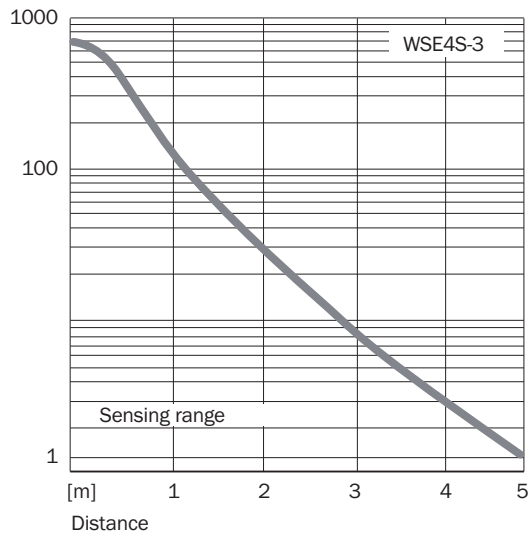

Sensing range diagram

WSE4S-3

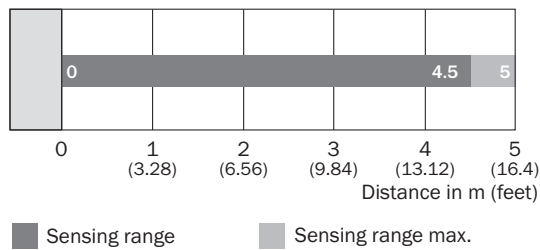

Dimensional drawing (Dimensions in mm (inch))

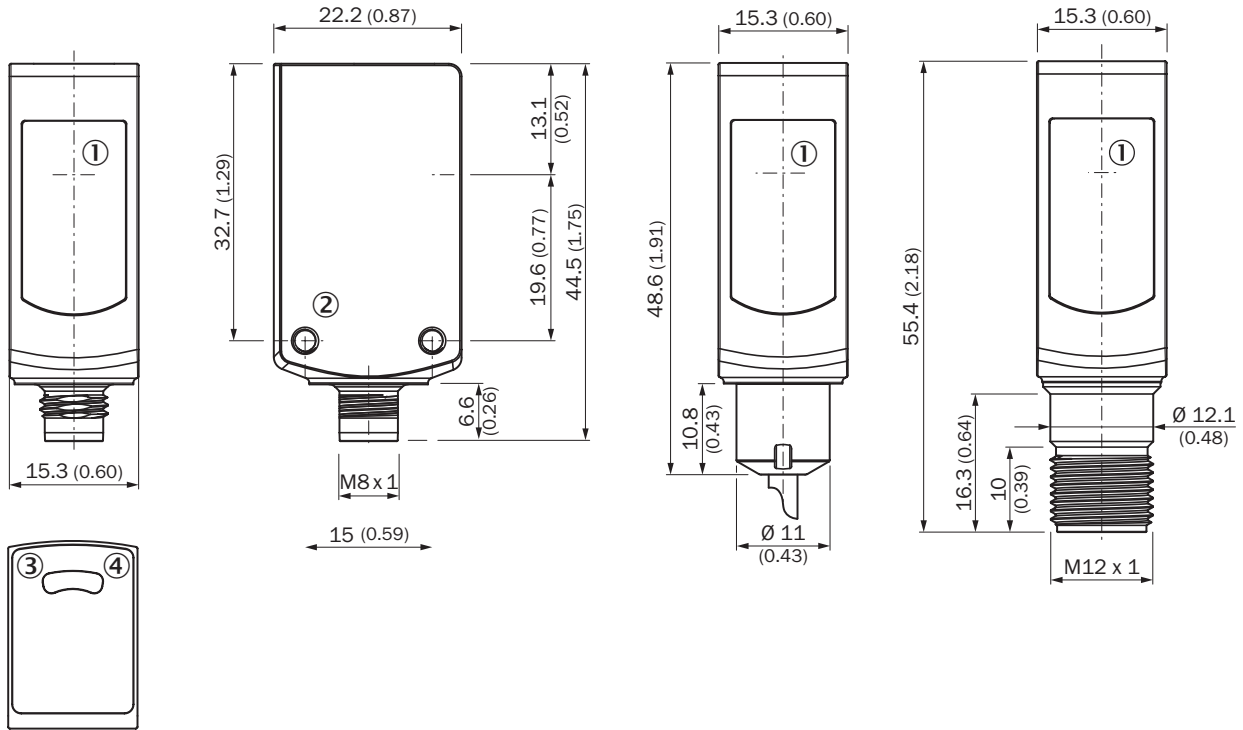

WL4S-3V, WLG4S-3V, without single teach-in button



- ① Center of optical axis
- ② Threaded mounting hole M3
- ③ LED indicator yellow: Status of received light beam
- ④ LED indicator green: Supply voltage active

Recommended accessories

Other models and accessories → www.sick.com/W4

	Brief description	Type	Part no.
Mounting brackets and plates			
	Mounting bracket for floor mounting, Stainless steel 1.4571, mounting hardware included	BEF-W4-B	2051630
Plug connectors and cables			
	<ul style="list-style-type: none"> • Connection type head A: Female connector, M8, 3-pin, straight • Connection type head B: Flying leads • Signal type: Sensor/actuator cable • Cable: 5 m, 3-wire, PP • Description: Sensor/actuator cable, unshielded • Connection systems: Flying leads • Note: This product is generally resistant to chemical cleaning agents (see ECOLAB) and other chemical compounds such as H2O2 and CH2O2. Before permanent installation is carried out, the material's resistance to the cleaning agent being used must be checked., Resistant against lactic acid & hydrogen peroxide (H2O2) • Application: Hygienic and washdown zones, Drag chain operation 	DOL-0803-G05MRN	6058505

SICK AT A GLANCE

SICK is one of the leading manufacturers of intelligent sensors and sensor solutions for industrial applications. A unique range of products and services creates the perfect basis for controlling processes securely and efficiently, protecting individuals from accidents and preventing damage to the environment.

We have extensive experience in a wide range of industries and understand their processes and requirements. With intelligent sensors, we can deliver exactly what our customers need. In application centers in Europe, Asia and North America, system solutions are tested and optimized in accordance with customer specifications. All this makes us a reliable supplier and development partner.

Comprehensive services complete our offering: SICK LifeTime Services provide support throughout the machine life cycle and ensure safety and productivity.

For us, that is “Sensor Intelligence.”

WORLDWIDE PRESENCE:

Contacts and other locations –www.sick.com